



INSTITUTO
SUPERIOR
TÉCNICO

UNIVERSIDADE TÉCNICA DE LISBOA
INSTITUTO SUPERIOR TÉCNICO

A transformation grammar-based methodology for housing
rehabilitation: meeting contemporary functional and ICT
requirements

APPENDIX

Sara Eloy Cardoso Rodrigues Freire da Cruz

Supervisor: Doctor José Manuel Pinto Duarte

Co-Supervisor: Doctor Maria Isabel Plácido Barbosa

Co-Supervisor: Doctor Renato Jorge Caleira Nunes

Thesis approved in public session to obtain the PhD Degree in Architecture

Jury final classification: Pass with Merit

Jury

Chairperson:

Rector of the Universidade Técnica de Lisboa

Members of the Committee:

Doctor Terry Weissman Knight

Doctor José Manuel Pinto Duarte

Doctor Teresa Frederica Tojal de Valsassina Heitor

Doctor Renato Jorge Caleira Nunes

Doctor Maria Alexandra de Lacerda Nave Alegre

Doctor Maria Isabel Plácido Barbosa



INSTITUTO
SUPERIOR
TÉCNICO

UNIVERSIDADE TÉCNICA DE LISBOA INSTITUTO SUPERIOR TÉCNICO

A transformation grammar-based methodology for housing rehabilitation: meeting contemporary functional and ICT requirements

APPENDIX

Sara Eloy Cardoso Rodrigues Freire da Cruz

Supervisor: Doctor José Manuel Pinto Duarte

Co-Supervisor: Doctor Maria Isabel Plácido Barbosa

Co-Supervisor: Doctor Renato Jorge Caleira Nunes

Thesis approved in public session to obtain the PhD Degree in Architecture

Jury final classification: Pass with Merit

Jury

Chairperson:

Rector of the Universidade Técnica de Lisboa

Members of the Committee:

Doctor Terry Weissman Knight, Full Professor, Massachusetts Institute of Technology

Doctor José Manuel Pinto Duarte, Full Professor, Faculdade de Arquitectura UTL

Doctor Teresa Frederica Tojal de Valsassina Heitor, Full Professor, Instituto Superior Técnico UTL

Doctor Renato Jorge Caleira Nunes, Assistant Professor, Instituto Superior Técnico UTL

Doctor Maria Alexandra de Lacerda Nave Alegre, Assistant Professor, Instituto Superior Técnico UTL

Doctor Maria Isabel Plácido Barbosa, Assistant Researcher, Laboratório Nacional de Engenharia Civil

Funding Institutions – Fundação para a Ciência e Tecnologia

APPENDIX 1

Analysis of the case study sample



Front façade

Date: 1954

Number of floors: 8

Project authorship: Arch. António Manuel Bentes



Door of building



Building entrance hall



Brief functional characterization

Access	One access to the building; main lift and service lift; One staircase
Number of dwellings	14
Non habitable divisions	Condominium store-rooms Caretaker's home Parking space in the open space in the rear of the building Shops in the ground floor

Brief constructional characterization

Structure and foundations	Hydraulic and reinforced concrete walls reaching the ground floor. Upward the exterior structure is made of reinforced concrete frame (pillars, beams and slabs). Continuous foundations and in some cases isolated concrete foundations. Reinforced solid concrete slabs. Reinforced concrete beam and pillar structure.
Exterior walls (façades and side walls)	Main and rear façade made of reinforced concrete beam and pillar structure filled with two panels of stretcher bonds and airspace of 0.08m, thicknesses of 0.4m including plaster. Side wall built from reinforced concrete with thicknesses of 0.2m in the last 4 floors and 0.3m in the remaining floors.
Interior walls	Partition walls between different dwellings and staircase partition walls - floor, ground floor, 1 st and 2 nd floor in solid header bond brick masonry and remaining floors in hollow header bond brick masonry. Partition walls between divisions - hollow stretcher bond brick masonry using cement and sand mortar (1/4): ground floor and 1 st floor – solid header bond brick masonry; 2 nd floor - double solid stretcher bond brick masonry; 3 rd and 4 th floor - solid stretcher bond brick masonry; 5 th and 6 th floor - hollow stretcher bond brick masonry.

Discrepancies, changes in the façade

Replacement of the windows in several floors with different designs. Double window frames in one case resulting in a

Original dwelling



Floor plan



Justified graph

Graph with a tree configuration with 1 ring
 Graph with 6 levels of depth
 15 spaces/nodes
 15 arcs/connections

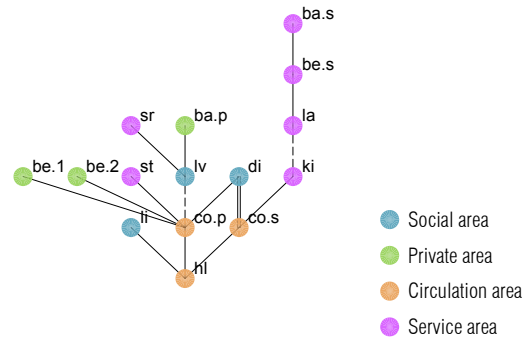

Convex map

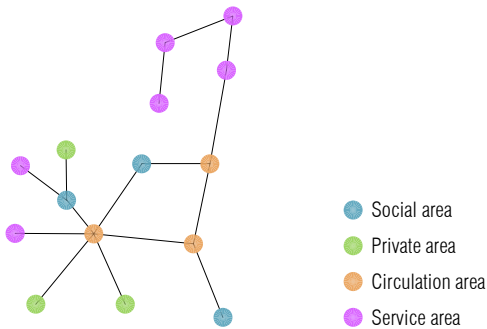

Distributness

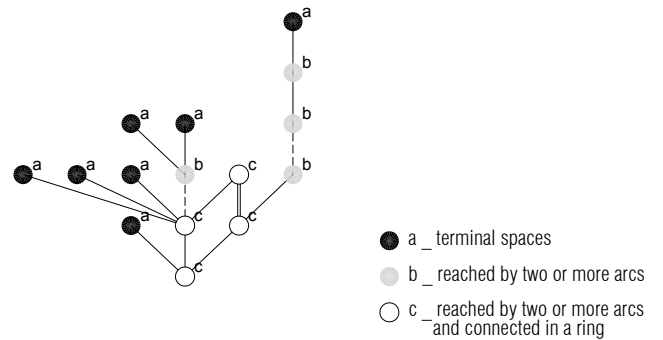

Controle

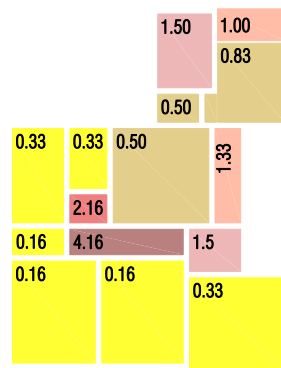

Entire dwelling
 Mean: 1.00

Contiguity

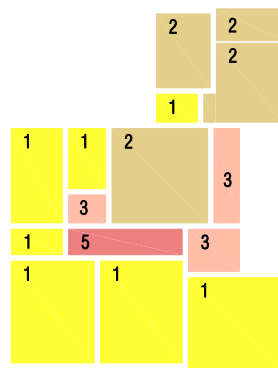

Depth

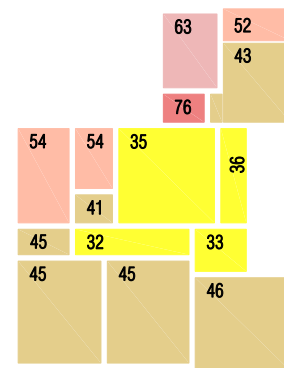

Entire dwelling
 Mean: 46.66

Integration

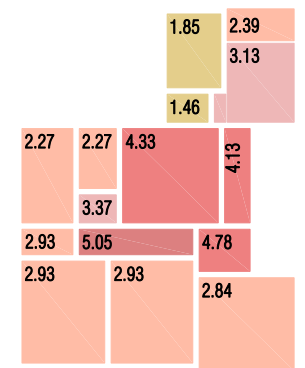

Entire dwelling
 Mean: 3.11

Adjacency (arcs)
 merged — door (single) == door (double) - - - - - passage ~ ~ ~ window





Front façade

Date: 1955
Number of floors: 9
Project authorship: Arch. n.154 (illegible signature)



Door of building



Building entrance hall

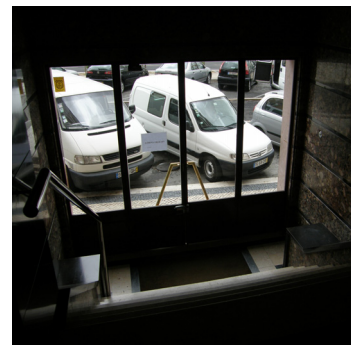

Brief functional characterization

Access Two access to the building; main and service lift; one staircase
Number of dwellings 16
Non habitable divisions Condominium store-rooms
 Caretaker's home

Brief constructional characterization

Structure and foundations Hydraulic and reinforced concrete walls reaching the ground floor. Upward the exterior structure is made of reinforced concrete frame (pillars, beams and slabs). Continuous foundations and in some cases isolated concrete foundations. Reinforced solid concrete slabs. Reinforced concrete beam and pillar structure.

Exterior walls (façades and side walls) Main and rear façade made of reinforced concrete beam and pillar structure filled with two panels of stretcher bonds and airspace of 0.08m, thicknesses of 0.4m including plaster.

Interior walls Partition walls between different dwellings and staircase partition walls - floor, ground floor, 1st and 2nd floor in solid header bond brick masonry and remaining floors in hollow header bond brick masonry.
 Partition walls between divisions - hollow stretcher bond brick masonry using cement and sand mortar (1/4): ground floor and 1st floor – solid header bond brick masonry; 2nd floor - double solid stretcher bond brick masonry; 3rd and 4th floor - solid stretcher bond brick masonry; 5th, 6th and 7th floor - hollow stretcher bond brick masonry.

Discrepancies, changes in the façade

Replacement of the windows in several floors with different designs. 5 apartments with closed balconies. Few cables through the building's main façade.

Original dwelling



Floor plan



Justified graph

Graph with a tree configuration with 1 ring
 Graph with 4 levels of depth
 14 spaces/nodes
 14 arcs/connections

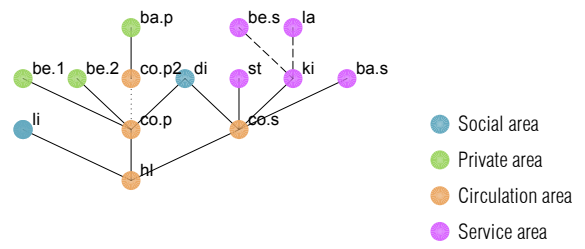

Convex map

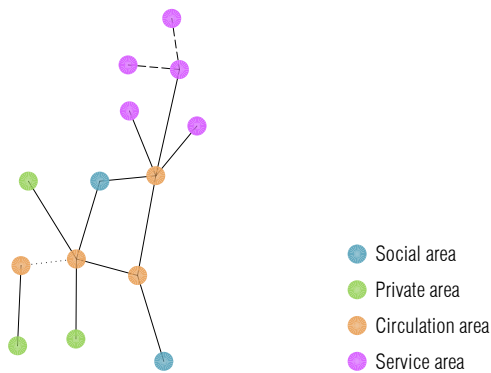

Distributness

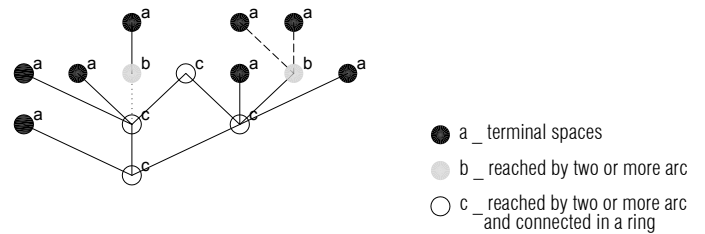

Controle

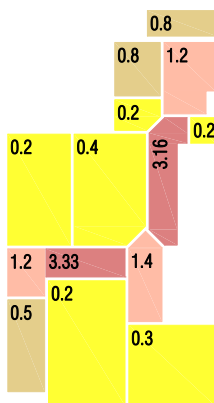

Entire dwelling
 Mean: 1.00

Contiguity

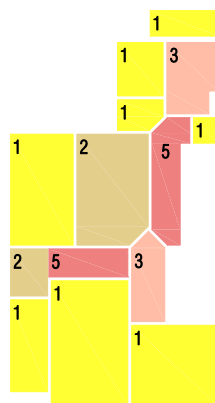

Depth

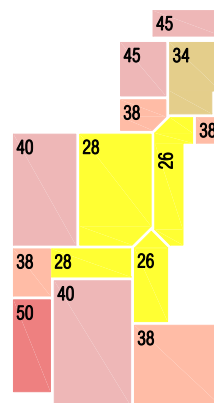

Entire dwelling
 Mean: 36.7

Integration

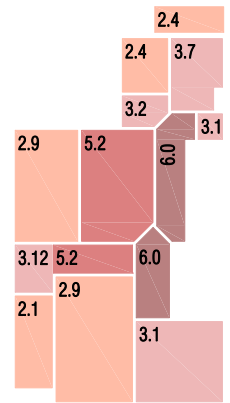

Entire dwelling
 Mean: 3.7

Adjacency (arcs)
 merged — door (single) = door (double) - - - - - passage ~ window

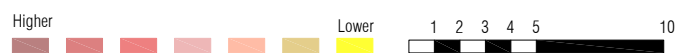



Front façade

Date: 1955
Number of floors: 9
Project authorship: Arch. Joaquim Ferreira



Door of building



Building entrance hall



Brief functional characterization

Access	Two access to the building; main lift and service lift; one staircase.
Number of dwellings	16
Non habitable divisions	Caretaker's home Shops in the ground floor

Brief constructional characterization

Structure and foundations	Structure is made of reinforced concrete frame (pillars, beams and slabs). Continuous foundations and in some cases isolated concrete foundations. Concrete slabs. Reinforced concrete beam and pillar structure.
Exterior walls (façades and side walls)	Main and rear façade made of reinforced concrete beam and pillar structure filled with two panels of stretcher bonds and airspace of 0.08m, thicknesses of 0.35m including plaster. Exterior parament is covered with <i>marmorite</i> . Exterior openings are embellished with cut stone masonry and bottom parament is also covered with cut stone masonry (limestone - lioz). In balconies the protective panel consists of a low masonry wall with a wrought or cast iron enamel painted railing on top. Side walls in brick masonry, thicknesses of 0.25m. Main and rear façade made of reinforced concrete beam and pillar structure filled with two panels of stretcher bonds and airspace of 0.08m, thicknesses of 0.35m including plaster.
Interior walls	Reinforced concrete beam structure on alternated floors. Partition walls between different dwellings and staircase partition walls - hollow header bond brick masonry. Partition walls between divisions - hollow stretcher bond brick masonry (in basement solid bricks were used). Interior walls have structure in beam and column, in alternate floors. Partitions and walls of the stairs tenants - brickwork stuck to since. Brickwork stuck to half time (in the basement is solid brick).

Discrepancies, changes in the façade

Replacement of the windows in several floors with different designs. Double window frames resulting in a more advance window surface with aesthetic impact on the main façade. Several closed balconies by glass windows. Last floor, retreated mansard from the façade. Air conditioning unit on the facade. Shop, with alteration of the original openings.

Original dwelling



Floor plan



Right : Left

Justified graph

Graph with a tree configuration with 1 ring
 Graph with 4 levels of depth
 14 spaces/nodes
 13 arcs/connections

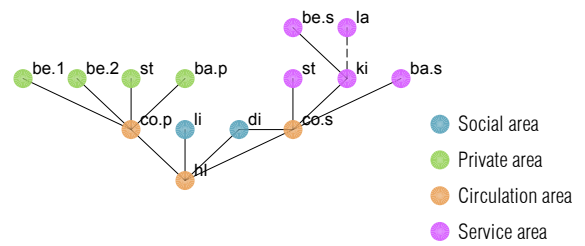

Convex map

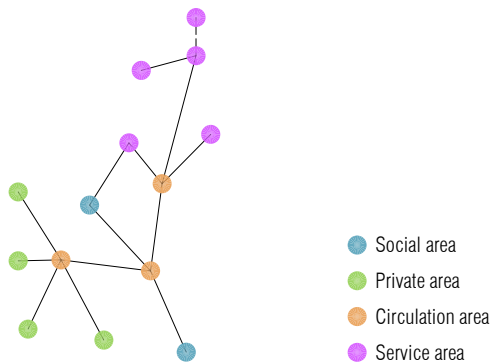

Distributness

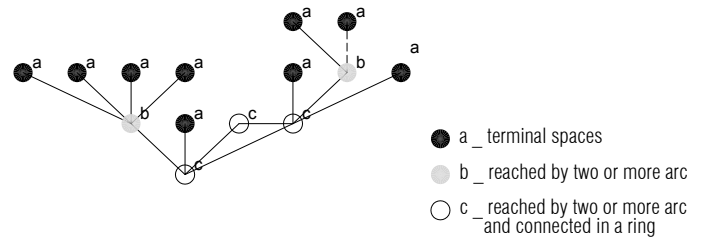

Controle

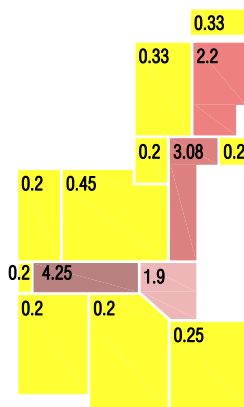

Entire dwelling
 Mean: 1.00

Contiguity

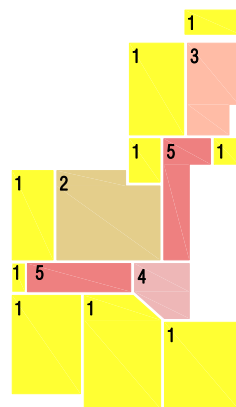

Depth

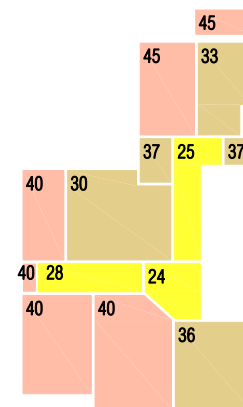

Entire dwelling
 Mean: 35.71

Integration

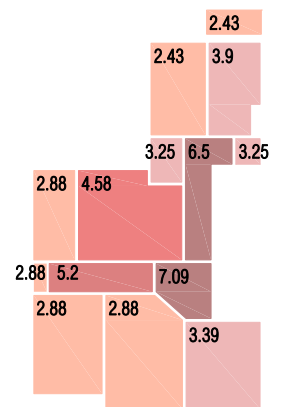

Entire dwelling
 Mean: 3.82

Adjacency (arcs)
 merged — door (single) == door (double) - - - - passage ~ ~ ~ window

Higher Lower
 1 2 3 4 5 10



Front façade

Date: 1956

Number of floors: 9

Project authorship: -



Door of building



Building entrance hall

Brief functional characterization

Access	One access to the building; main lift and service lift; one staircase
Number of dwellings	18
Non habitable divisions	Caretaker's home Shops in the ground floor

Brief constructional characterization

Structure and foundations	Foundations made of hydraulics masonry and concrete. Structure is made of reinforced concrete frame (pillars, beams and slabs).
Exterior walls (façades and side walls)	Main and rear façade made of reinforced concrete beam and pillar structure filled with two panels of stretcher bonds and airspace of 0.08m. Exterior walls are covered with a painted coating (made of cement and sand mortar) Cut stone masonry covers the ground floor of the main façade up to the level of the first floor. Side wall made of reinforced concrete beam and pillar structure filled with, filled with 2 holes bricks, with a thickness of 22cm.
Interior walls	The partition walls are built from stretcher bond brick masonry with thickness of: 0.15m on 6th floor and upper floors; 0.18m on the ground floor up to the 5th floor; 0.25m on the basement. Beams in interior walls on the 2nd, 4th and 6th floors. Interior walls are plastered with a lime and sand mortar. In the bathroom, kitchen and laundry areas the walls are covered with decorative tiles to a height of 1.5m and the rest of the wall is enamel-painted.

Discrepancies, changes in the façade

Replacement of the windows in several floors with different designs. Double window frames in one case resulting in a more advance window surface. New green blinds on the last floor different from all the building's blinds.
In the last floor, the retreated mansard was forward to the main façade surface. Several air conditioning devices mounted on the façade. Several cables through the building's main façade.

Original dwelling



Floor plan

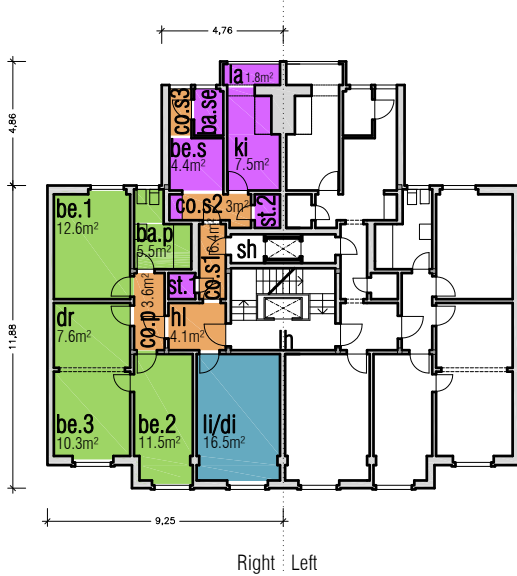

Justified graph

Graph with a tree configuration with 1 ring
 Graph with 6 levels of depth
 17 spaces/nodes
 17 arcs/connections

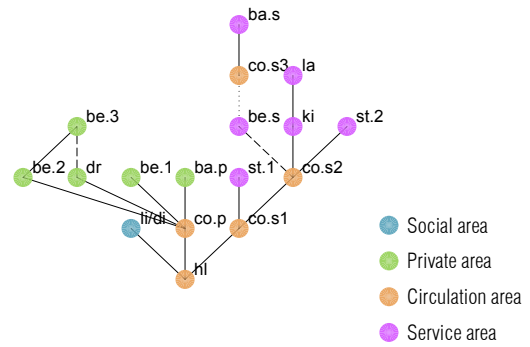

Convex map

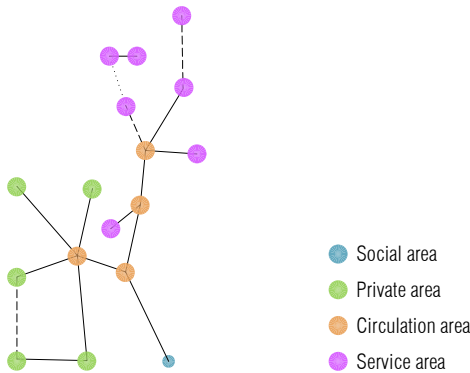

Distributness

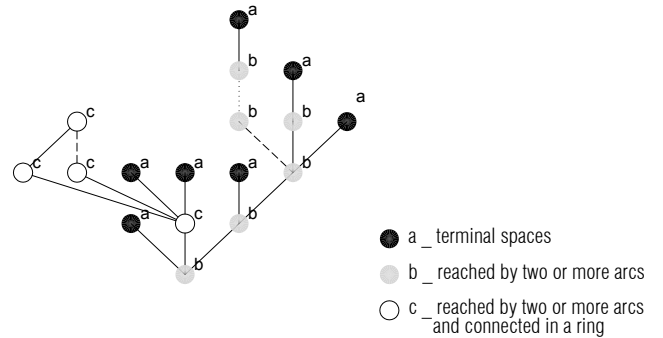

Controle

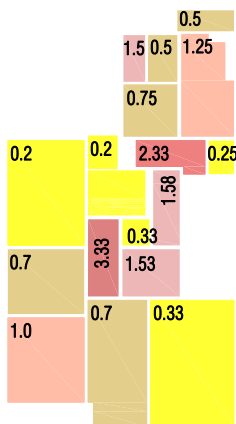

Entire dwelling
 Mean: 1.00

Contiguity

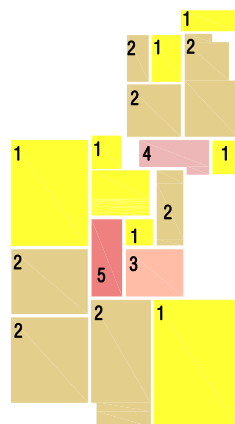

Depth

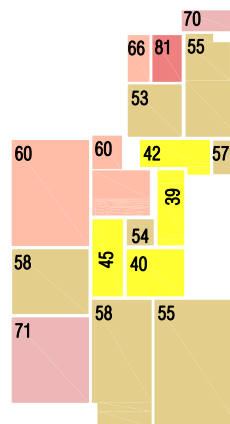

Entire dwelling
 Mean: 57

Integration

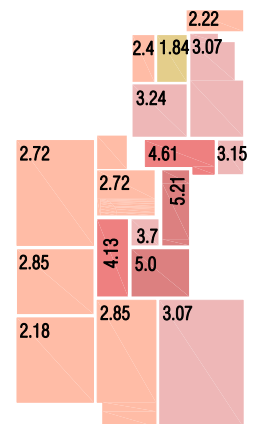

Entire dwelling
 Mean: 3.2





Front façade

Date: 1955
Number of floors: 8
Project authorship: Arch. n.77 (illegible signature)



Door of building



Building entrance hall

Brief functional characterization

Access Two access to the building; main lift and service lift; one staircase.
Number of dwellings 16
Non habitable divisions Caretaker's home

Brief constructional characterization

Structure and foundations Continuous foundations.
 Structure is made of reinforced concrete frame (pillars, beams and slabs).
Exterior walls (façades and side walls) Main and rear façade (exterior wall) made of reinforced concrete beam and pillar structure filled with two panels of stretcher bonds and airspace of 0.08m - thicknesses of 0.35m.
 Side walls made of reinforced concrete beam and pillar structure filled of special brick.
Interior walls On the 4th, 5th, 6th and 7th floors interior walls are non loadbearing.
 Partition walls between different dwellings and staircase and lift partition walls in header bond brick masonry and remaining interior partitions in stretcher bond brick masonry.

Discrepancies, changes in the façade

In the last floor, the retreated mansard was forward to the main façade surface. Few closed balconies by glass windows. Several air conditioning devices mounted on the façade. Several cables through the building's main façade. In the shop the original openings where changed. TV antenna installed on a balcony.

Original dwelling



Floor plan



Justified graph

Graph with a tree configuration with 1 ring
 Graph with 5 levels of depth
 13 spaces/nodes
 14 arcs/connections

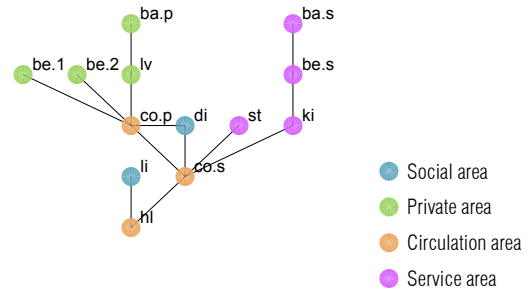

Convex map

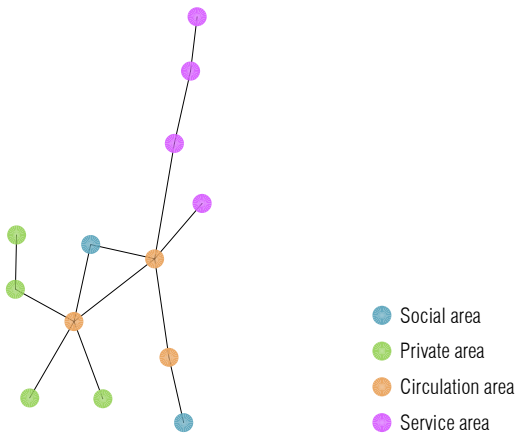

Distributness

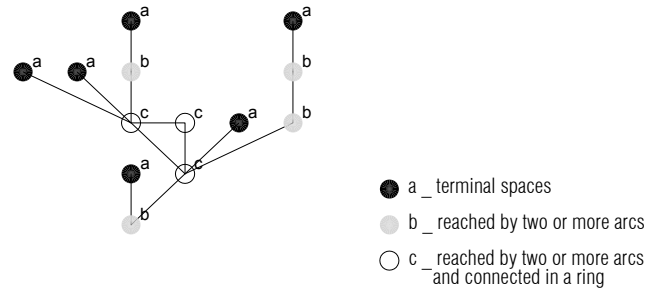

Controle

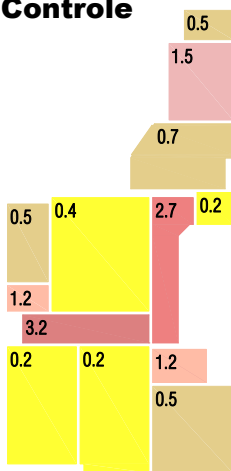

Entire dwelling
 Mean: 1.00

Contiguity

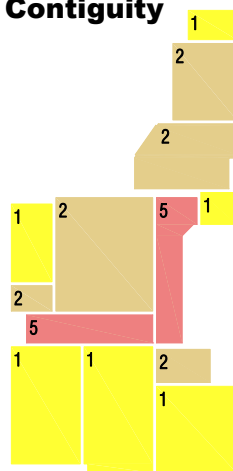

Depth

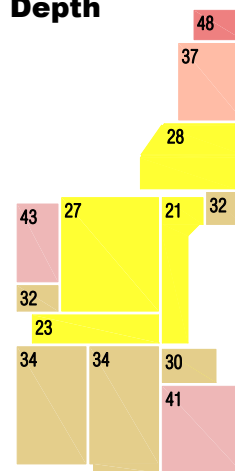

Entire dwelling
 Mean: 33.07

Integration

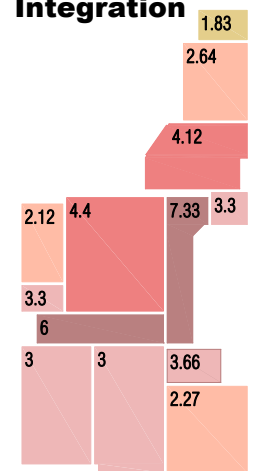

Entire dwelling
 Mean: 3.61

Adjacency (arcs)
 merged — door (single) == door (double) - - - - - passage ~ ~ ~ window





Front façade

Date: 1953
Number of floors: 9
Project authorship: Arch. João Simões



Door of building



Building entrance hall



Brief functional characterization

Access Two access to the building; main lift and service lift; one staircase.
Number of dwellings 15
Non habitable divisions Caretaker's home
 Shops in the ground floor

Brief constructional characterization

Structure and foundations Foundations made of timber piles or pier foundations. Light flooring in the form of prefabricated and pre-stressed reinforced concrete components ("corfed" slabs). Reinforced concrete beam and pillar structure.

Exterior walls (façades and side walls) Main and rear façade made of reinforced concrete beam and pillar structure filled with two panels of hollow brick stretcher bonds and airspace of 0.05m.

Interior walls Partition walls between different dwellings, lift and staircase partition walls in hollow header bond brick masonry.
 Partition walls between divisions in hollow stretcher bond brick masonry.
 The interior walls are covered with plaster over a sand-based rendering. The final coating consists of an oil-based paint.

Discrepancies, changes in the façade

In the last floor, the retreated mansard was forward to the main façade surface. Balcony on the 5th floor with a large wood shade structure. Replacement of the windows in several floors with different designs. Double window frames in several floors resulting in a more advance window surface.

Av. Igreja, 63 [right]

(Left) Net floor area: 121.3m² | Gross floor area: 148m² (Right) Net floor area: 118.6m² | Gross floor area: 144.4m²

type a

Original dwelling



Floor plan

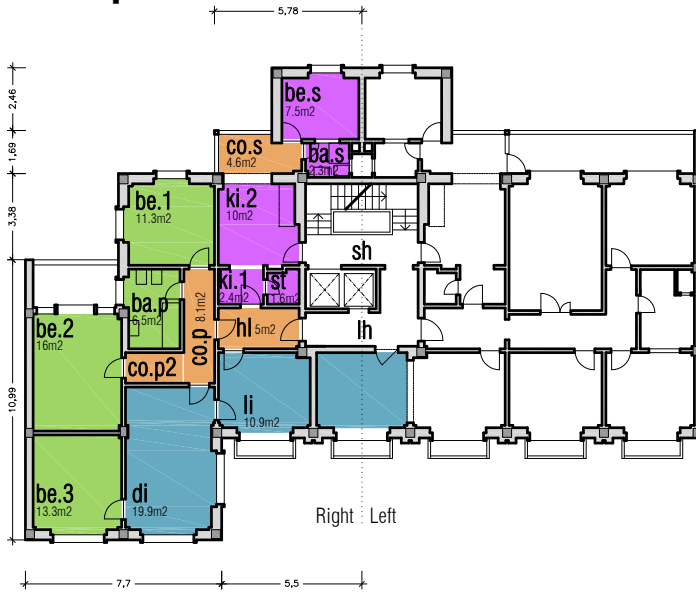

Justified graph

Graph with a tree configuration with 1 ring
 Graph with 5 levels of depth
 15 spaces/nodes
 16 arcs/connections
 (windows connections are excluded)

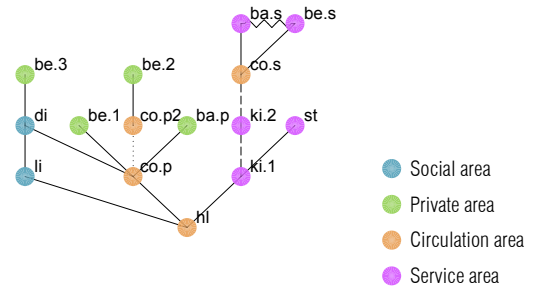

Convex map

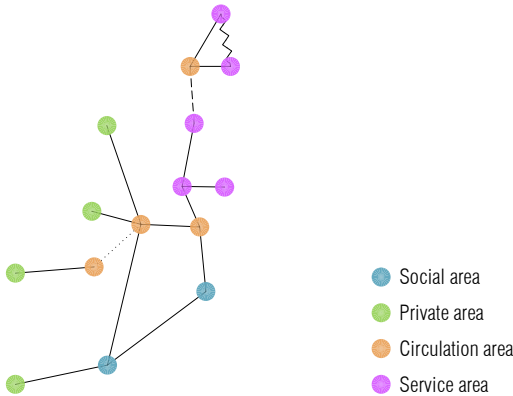

Distributness

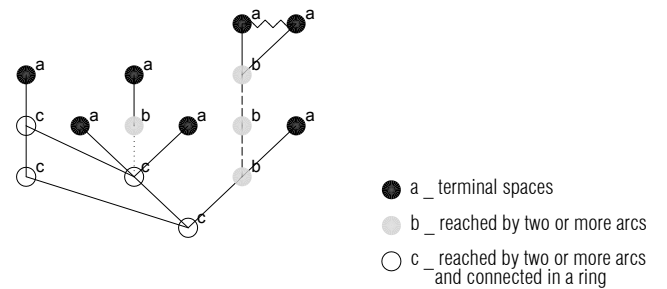

Controle

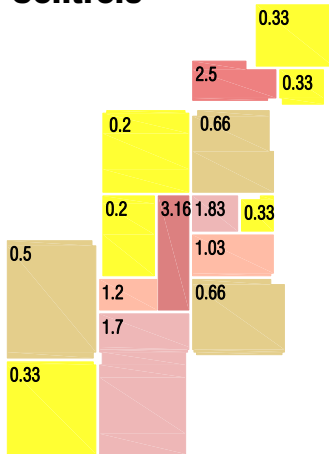

Entire dwelling
 Mean: 1.00

Contiguity

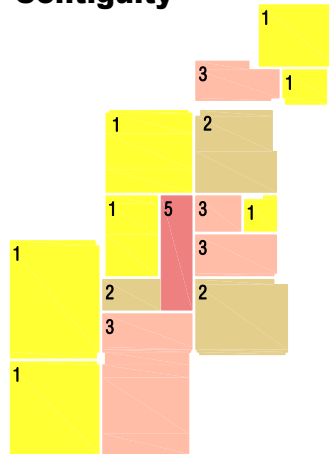

Depth

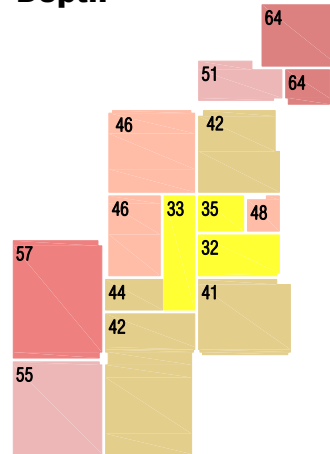

Entire dwelling
 Mean: 46.66

Integration

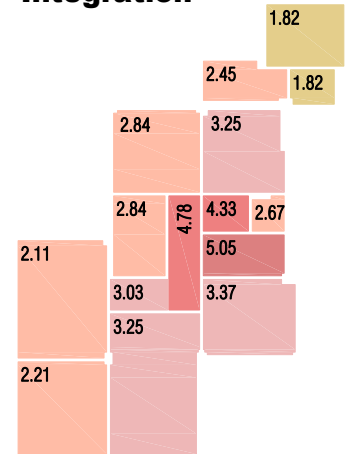

Entire dwelling
 Mean: 3.05



Av. Igreja, 63 [left]

(Left) Net floor area: 121.3m² | Gross floor area: 148m² (Right) Net floor area: 118.6m² | Gross floor area: 144.4m²

type a

Original dwelling



Floor plan



Justified graph

Graph with a tree configuration
Graph with 5 levels of depth
16 spaces/nodes
17 arcs/connections
(windows connections are excluded)

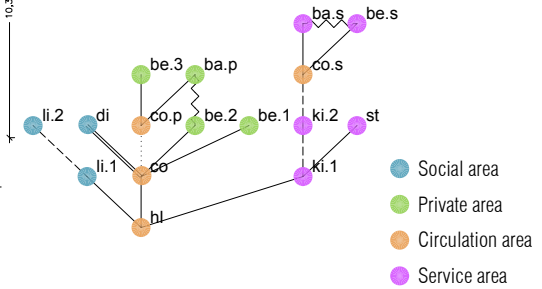

Convex map

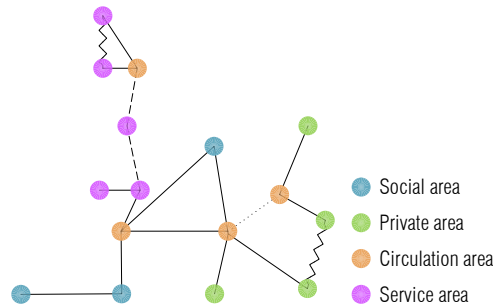

Distributness

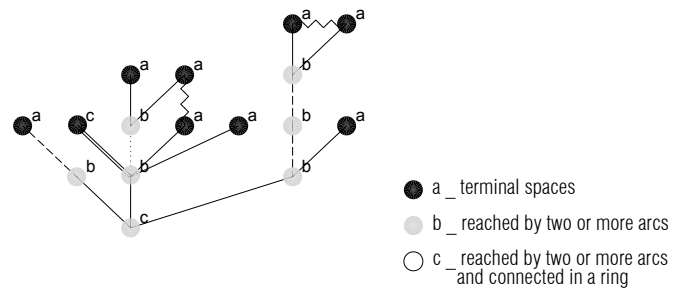

Controle

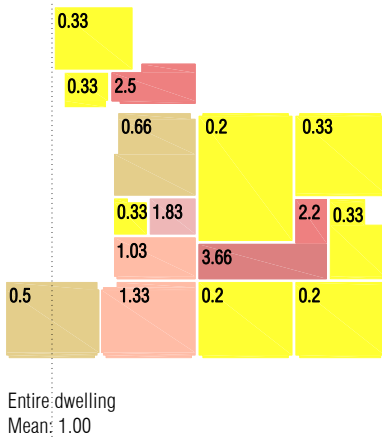

Contiguity

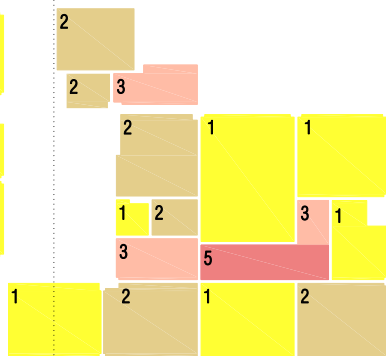

Depth

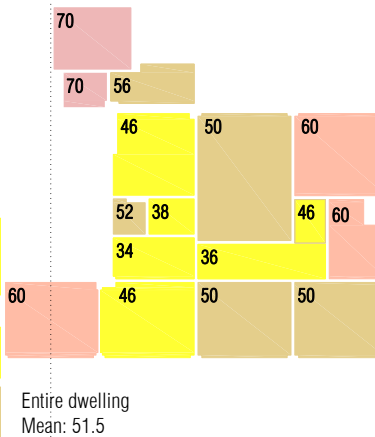

Integration

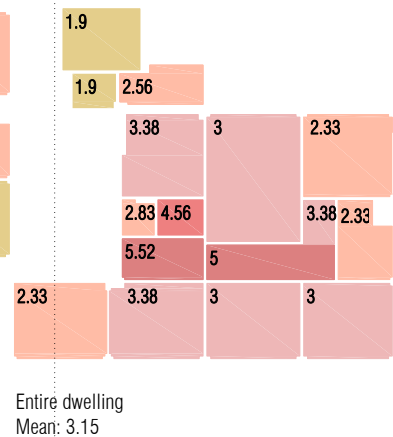

Adjacency (arcs) merged door (single) door (double) passage window Higher Lower 1 2 3 4 5 10



Front façade

This process was burned in a fire occurred in the CML archives some years ago.

Date: -
Number of floors: 7
Project authorship: -



Door of building



Building entrance hall

Brief functional characterization

Access One access to the building; main lift; two staircases.
Number of dwellings 12
Non habitable divisions Caretaker's home
 Shops in the ground floor

Brief constructional characterization

Structure and foundations -
Exterior walls (façades and side walls) -
Interior walls -

Discrepancies, changes in the façade

Few cables through the building's main façade. Coexistence of green and white blinds.

Original dwelling



Floor plan

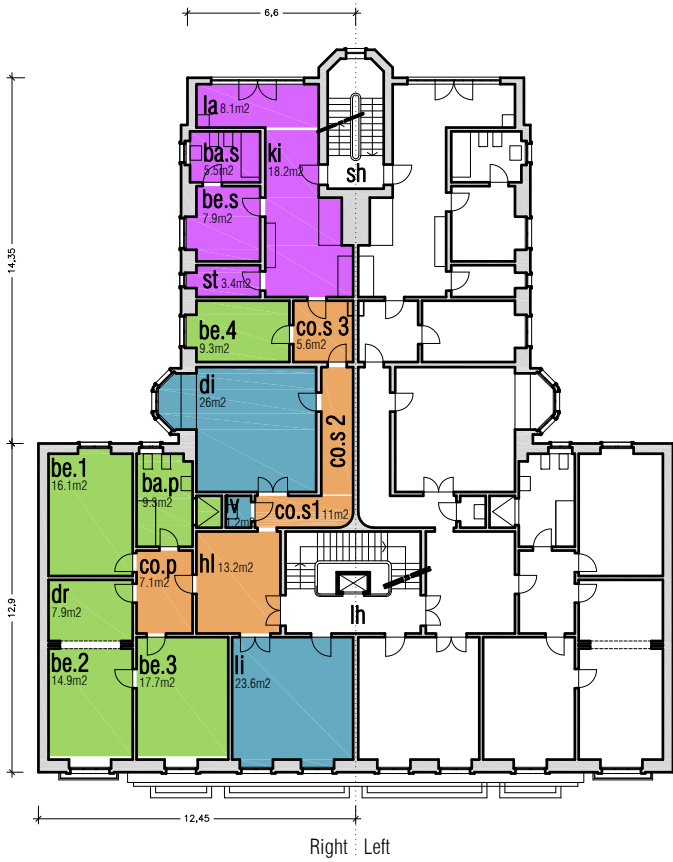

Justified graph

Graph with a tree configuration with 2 ring
 Graph with 7 levels of depth
 19 spaces/nodes
 20 arcs/connections

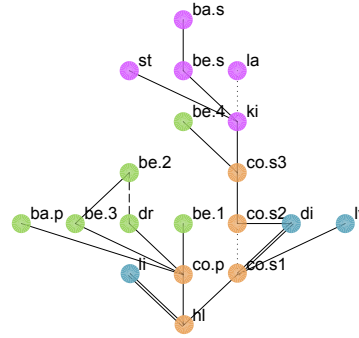

Convex map

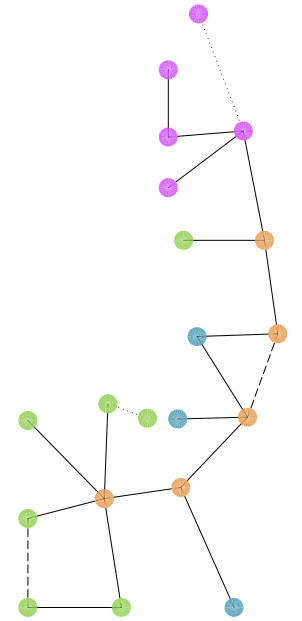

Distributness

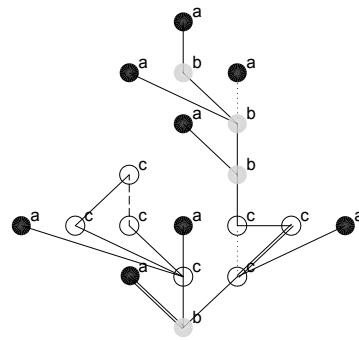

- Social area
- Private area
- Circulation area
- Service area
- a _ terminal spaces
- b _ reached by two or more arcs
- c _ reached by two or more arcs and connected in a ring

Controle

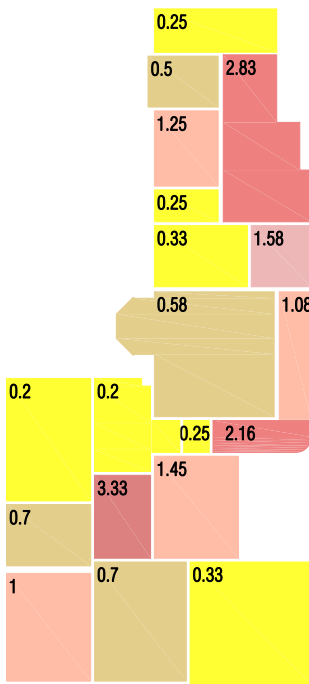

Entire dwelling
 Mean: 1.00

Contiguity

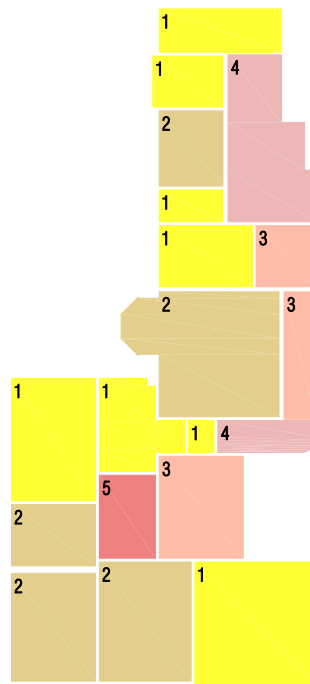

Depth

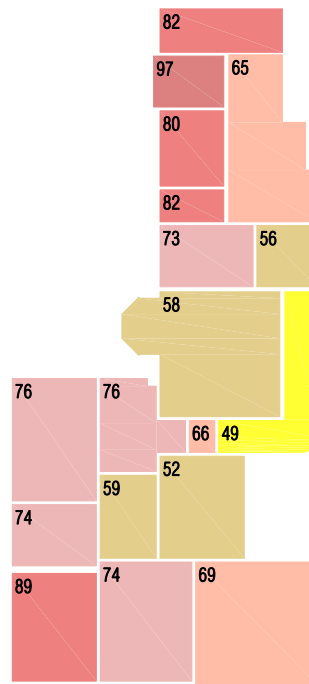

Entire dwelling
 Mean: 69.89

Integration

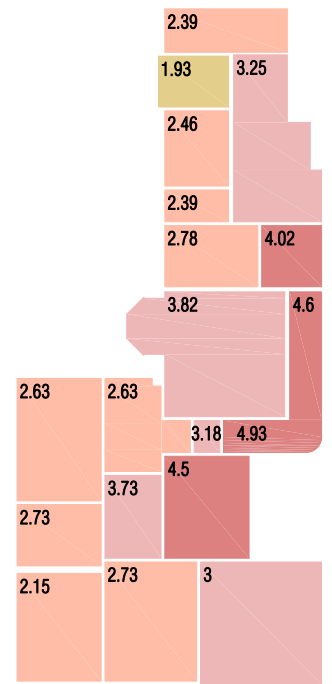

Entire dwelling
 Mean: 3.15

Adjacency (arcs)
 merged — door (single) = door (double) - - - - - passage ~ ~ ~ window

Higher Lower
 1 2 3 4 5 10



Front façade

Date: 1953

Number of floors: 7

Project authorship: Eng. n.115



Door of building



Building entrance hall

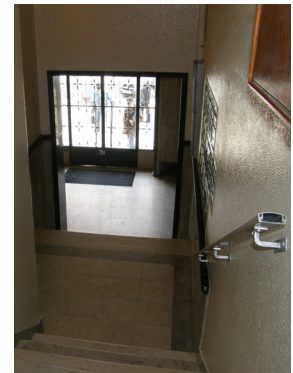

Brief functional characterization

Access	One access to the building; main lift; two staircases.
Number of dwellings	12
Non habitable divisions	Caretaker's home Shops in the ground floor

Brief constructional characterization

Structure and foundations	Reinforced concrete structure.
Exterior walls (façades and side walls)	Main façade made of reinforced concrete – continuous wall on the outside panel - with airspace and a brick panel on the interior side of the wall. Rear façade made of reinforced concrete beam and pillar structure filled with two panels of stretcher bonds and airspace of 0.1m. Side wall made of reinforced concrete.
Interior walls	The interior walls and ceilings are covered with plaster over a sand-based rendering. The final coating consists of an oil-based paint.

Discrepancies, changes in the façade

Several cables through the building's main façade. Several air conditioning devices mounted on the façade.

Av. Guerra Junqueiro, 14

Net floor area: 153.5m² | Gross floor area: 188m²

type **c**

Original dwelling



Floor plan

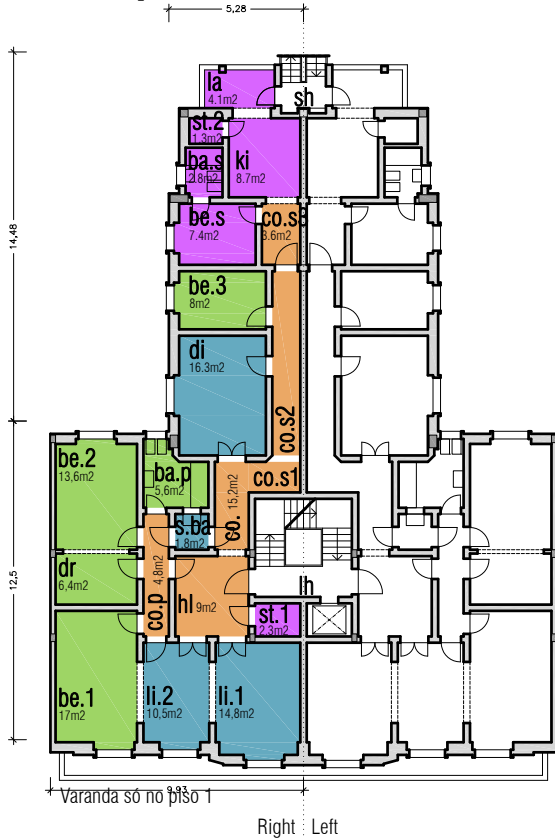

Justified graph

Graph with a tree configuration with 6 rings
Graph with 7 levels of depth
21 spaces/nodes
26 arcs/connections
(windows connections are excluded)

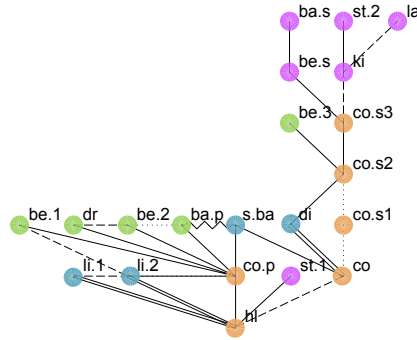

Distributness

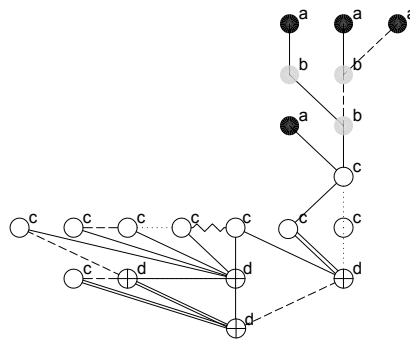

Convex map

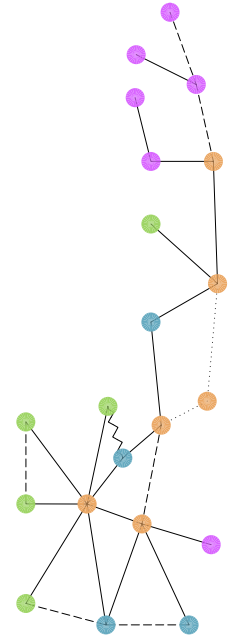

- Social area
- Private area
- Circulation area
- Service area
- a _ terminal spaces
- b _ reached by two or more arcs
- c _ reached by two or more arcs and connected in a ring
- ⊕ d _ reached by two or more arcs and connected by ≥ 2 rings

Controle

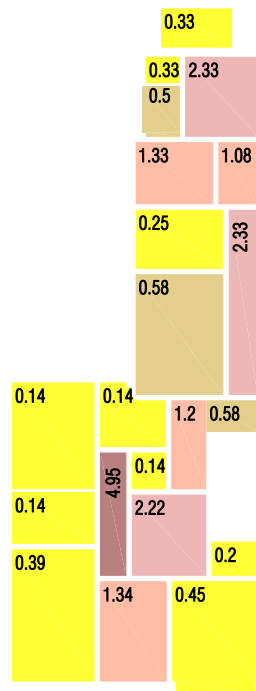

Entire dwelling
Mean: 1.00

Contiguity

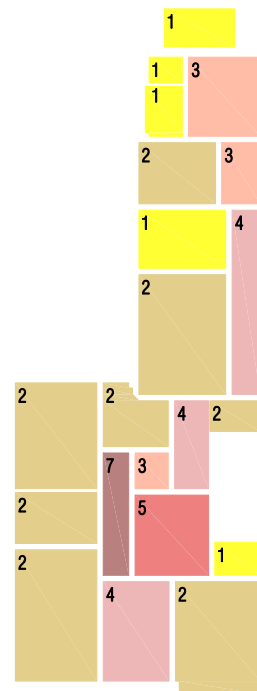

Depth

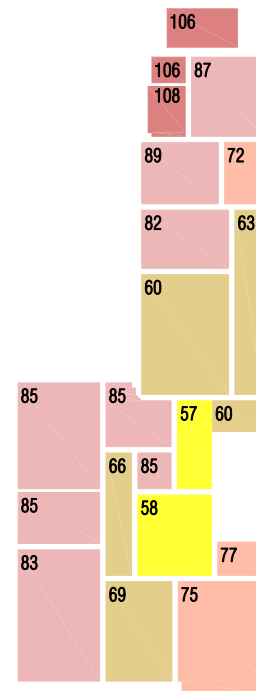

Entire dwelling
Mean: 78.95

Integration

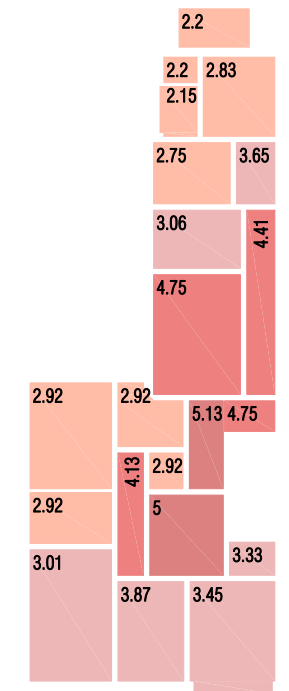

Entire dwelling
Mean: 3.44

Adjacency (arcs)
..... merged — door (single) = door (double) - - - - passage ~ window

Higher Lower
1 2 3 4 5 10



Front façade

Date: 1953

Number of floors: 5

Project authorship: -



Door of building



Building entrance hall



Brief functional characterization

Access	One exterior access to the building; main lift and service lift, one staircase.
Number of dwellings	10
Non habitable divisions	Condominium store-rooms Caretaker's home

Brief constructional characterization

Structure and foundations	Continuous foundations made of hydraulics masonry beneath dividing walls. Reinforced concrete structure.
Exterior walls (façades and side walls)	Main and rear façade made of reinforced concrete beam and pillar structure filled with two panels of stretcher bonds and airspace of 0.08m, thicknesses of 0.35m including plaster. Side walls made of continuous reinforced concrete, thickness of 0.3m on the upper 4 floors and 0.3m on the ground one and basement.
Interior walls	Partition walls between divisions - hollow stretcher bond brick masonry: 0.25m on the basement; 0.18 on the ground floor; 0.15m on the remaining floors. Concrete beams on the ceiling of the 2 nd floor and ground floor.

Discrepancies, changes in the façade

Replacement of the window frame in one of the floors with other of different colour and material. Different type of blinds along the building (colour and material). Several cables through the building's main façade.

Pr. Afrânio Peixoto, 12

Net floor area: 72.1m² | Gross floor area: 88.6m²

type **b**

Original dwelling



Floor plan



Justified graph

Graph with a tree configuration with 1 ring
 Graph with 5 levels of depth
 13 spaces/nodes
 14 arcs/connections
 (windows connections are excluded)

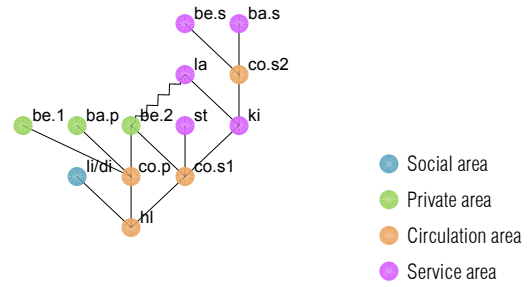

Convex map

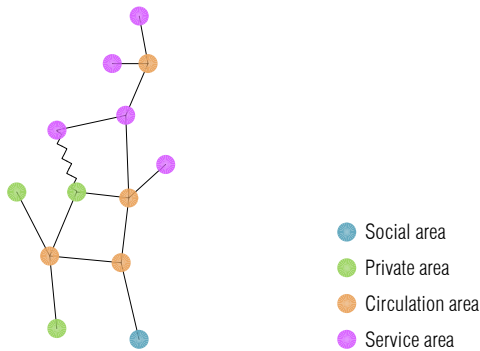

Distributness

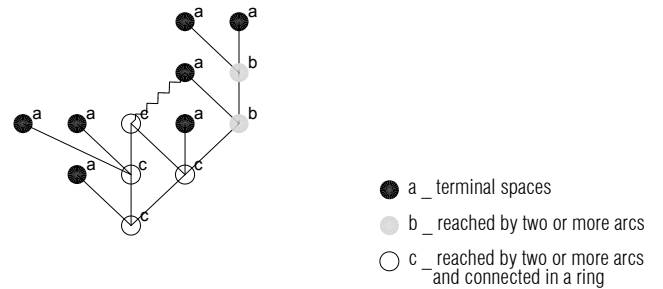

Controle

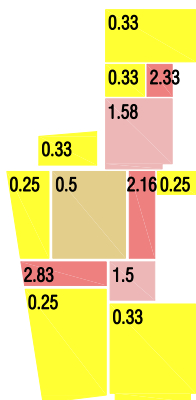

Entire dwelling
 Mean: 1.00

Contiguity

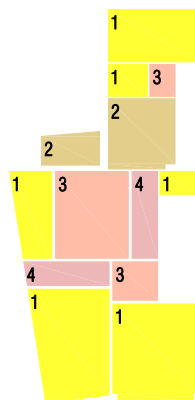

Depth

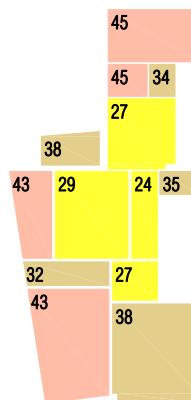

Entire dwelling
 Mean: 35.38

Integration

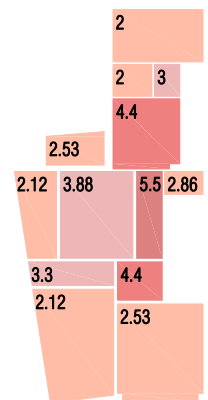

Entire dwelling
 Mean: 3.12





Front façade

Date: 1950

Number of floors: 5

Project authorship: -



Door of building



Building entrance hall

Brief functional characterization

Access	Two exterior access to the building; main lift and service lift, both only with stair.
Number of dwellings	10
Non habitable divisions	Caretaker's home

Brief constructional characterization

Structure and foundations	Reinforced concrete structure.
Exterior walls (façades and side walls)	Main and rear façade made of reinforced concrete beam and pillar structure filled with two panels of stretcher bonds hollow brick masonry and airspace. Continuous reinforced concrete wall on the ground floor, thickness of 0.8m. Side walls made of reinforced concrete.
Interior walls	Interior walls: stretcher bonds hollow brick masonry (4 th and 5 th floors); stretcher bonds solid brick masonry (2 nd and 3 rd floors); double stretcher bonds solid brick masonry (ground -floor); header bonds solid brick masonry (basement) – thickness 0.25m

Discrepancies, changes in the façade

Blinds with different colours along the building. Several cables through the building's main façade.

Pr. Afrânio Peixoto, 13

Net floor area: 112.1m² | Gross floor area: 135m²

type a

Original dwelling



Floor plan

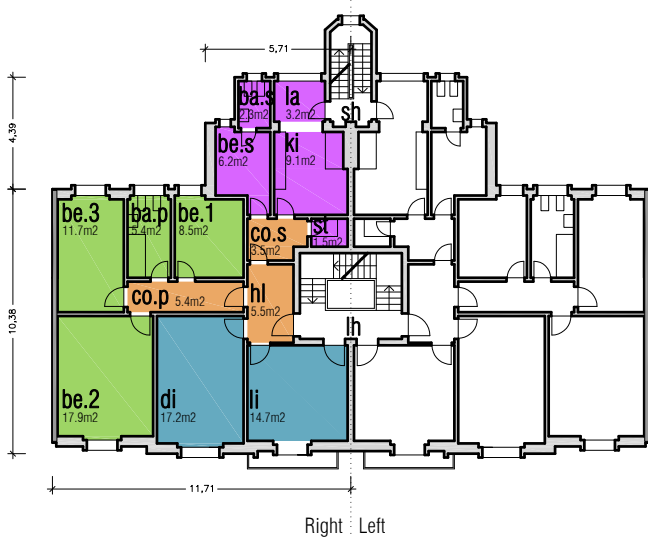

Justified graph

Graph with a tree configuration
Graph with 4 levels of depth
14 spaces/nodes
13 arcs/connections

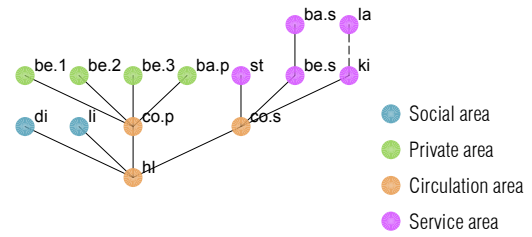

Convex map

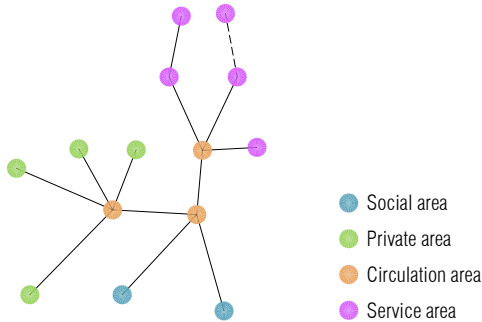

Distributness

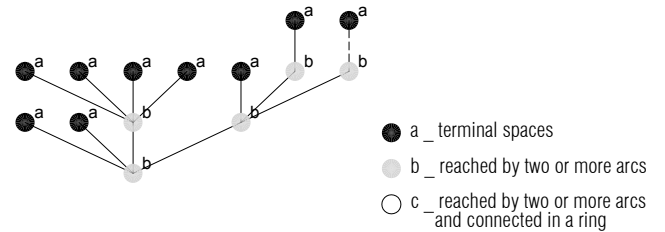

Controle

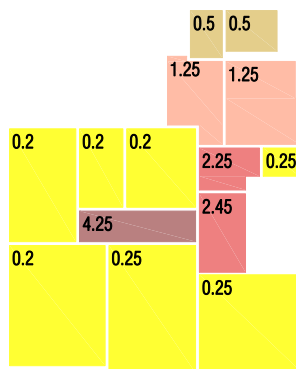

Entire dwelling
Mean: 1.00

Contiguity

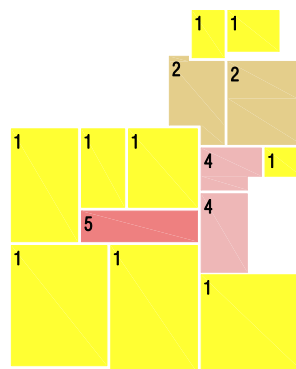

Depth

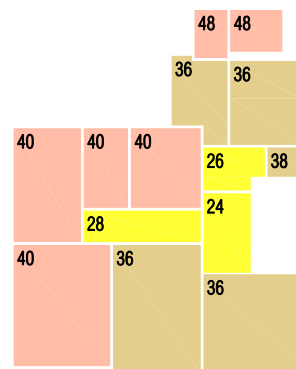

Entire dwelling
Mean: 36.85

Integration

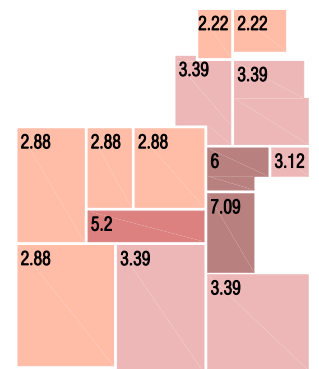

Entire dwelling
Mean: 3.64

Adjacency (arcs)
..... merged — door (single) = door (double) - - - - passage ~ window





Front façade

Date: 1943

Number of floors: 6

Project authorship: Eng. n.139 (illegible signature)



Main door of building and service door



Building entrance hall



Brief functional characterization

Access	One exterior access to the building; main lift, two staircases.
Number of dwellings	12
Non habitable divisions	Condominium store-rooms Caretaker's home

Brief constructional characterization

Structure and foundations	-
Exterior walls (façades and side walls)	-
Interior walls	-

Discrepancies, changes in the façade

Two air condition devices mounted on the façade. Cables through the building's main façade.

Pr. Dom João do Rio, 6 [right]

(Left) Net floor area: 120.8m² | Gross floor area: 148.7m² (Right) Net floor area: 131.4m² | Gross floor area: 161.7m²

type **d**

Original dwelling



Floor plan

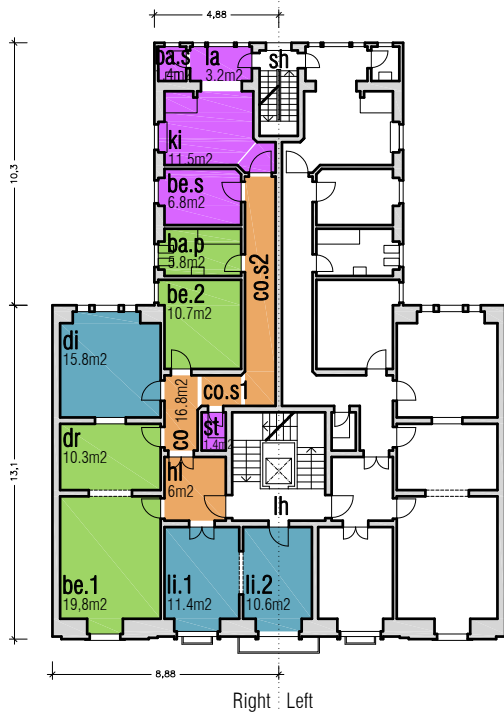

Justified graph

Graph with a tree configuration with 1 ring
Graph with 7 levels of depth
16 spaces/nodes
16 arcs/connections
(windows connections are excluded)

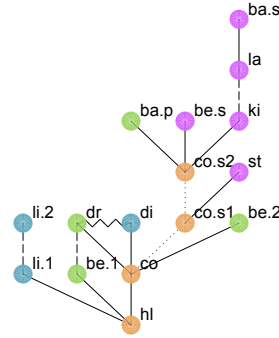

Convex map

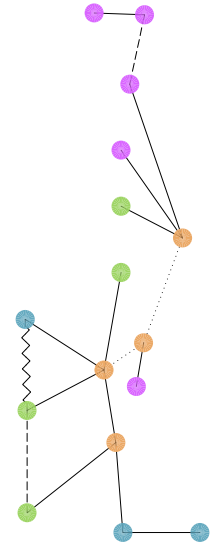

Distributness

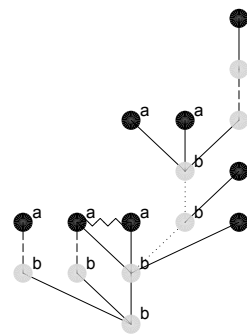

- Social area
- Private area
- Circulation area
- Service area
- a _ terminal spaces
- b _ reached by two or more arcs
- c _ reached by two or more arcs and connected in a ring

Controle

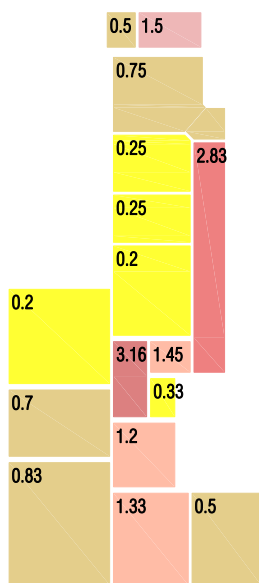

Entire dwelling
Mean: 1.00

Contiguity

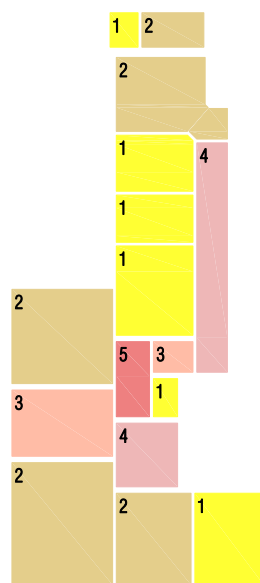

Depth

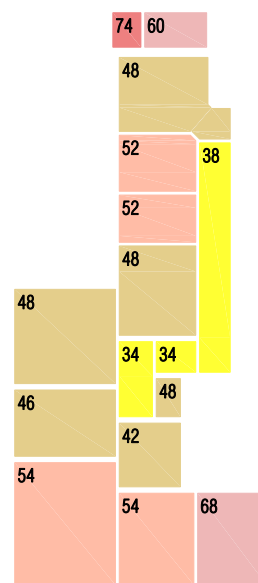

Entire dwelling
Mean: 44.26

Integration

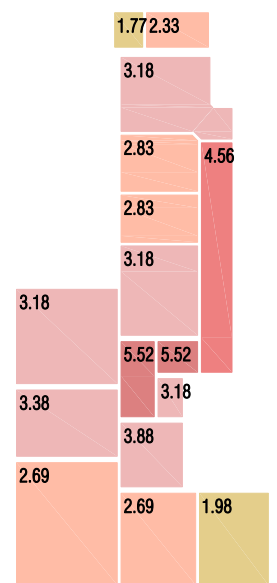

Entire dwelling
Mean: 3.2

Adjacency (arcs)
..... merged — door (single) = door (double) - - - - passage ~ window

Higher Lower 1 2 3 4 5 10

Pr. Dom João do Rio, 6 [left]

(Left) Net floor area: 120.8m² | Gross floor area: 148.7m² (Right) Net floor area: 131.4m² | Gross floor area: 161.7m²

type **d**

Original dwelling



Floor plan

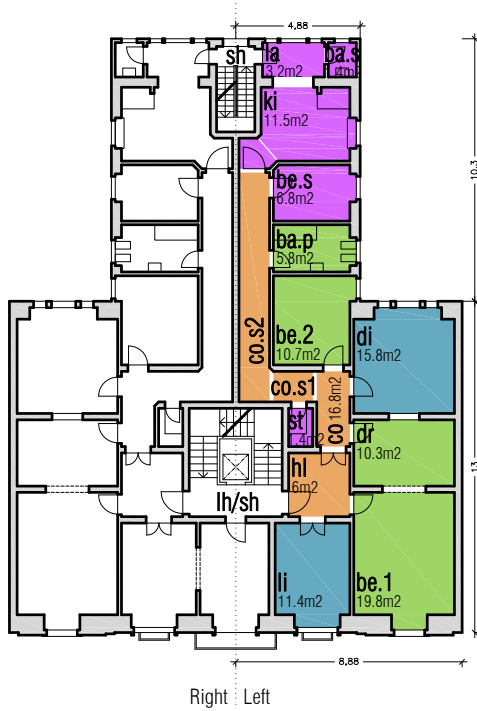

Justified graph

Graph with a tree configuration with 1 ring
 Graph with 7 levels of depth
 15 spaces/nodes
 15 arcs/connections
 (windows connections are excluded)

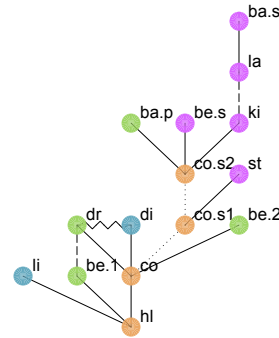

Convex map

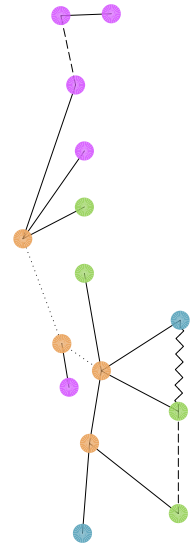

Distributness

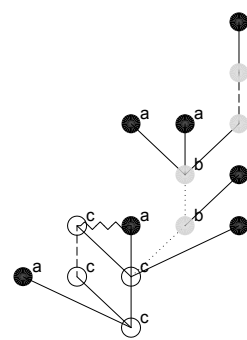

- Social area
- Private area
- Circulation area
- Service area
- a _ terminal spaces
- b _ reached by two or more arcs
- c _ reached by two or more arcs and connected in a ring

Controle

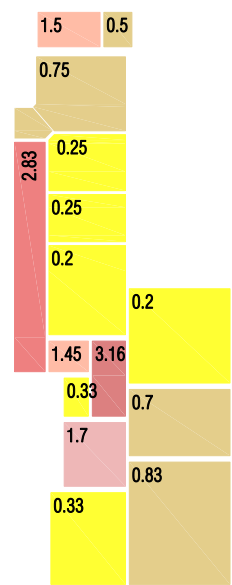

Entire dwelling
 Mean: 1.00

Contiguity

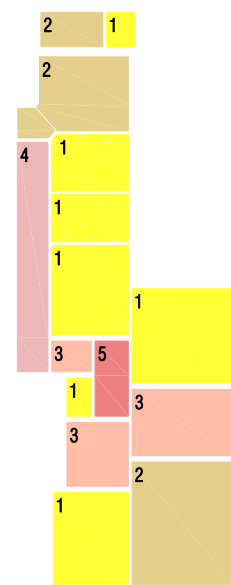

Depth

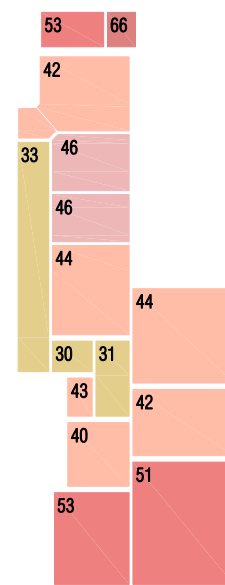

Entire dwelling
 Mean: 44.26

Integration

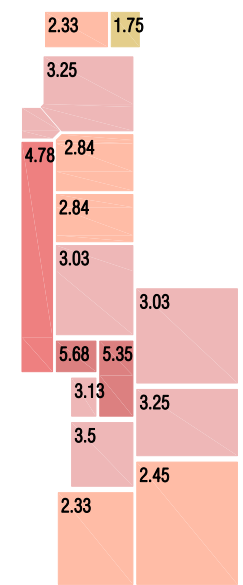

Entire dwelling
 Mean: 3.3

Adjacency (arcs)
 merged — door (single) = door (double) - - - passage ~ window

Higher ■ ■ ■ Lower

1 2 3 4 5 10



Front façade

Date: 1939
Number of floors: 4
Project authorship: Arch. João Simões



Door of the building



Building entrance hall



Brief functional characterization

Access One access to the building; two staircases.
Number of dwellings 8
Non habitable divisions Caretaker's home

Brief constructional characterization

Structure and foundations Continuous walls made of hydraulics masonry. Foundations made of reinforced concrete beneath pillars. Reinforced concrete structure.
Exterior walls (façades and side walls) Main façade made of hydraulics stone masonry. Rear façade made of hydraulics stone masonry and solid header bond brick masonry.
Interior walls Hollow header bond brick masonry.

Discrepancies, changes in the façade

Replacement of the windows in some floors with different designs. Few cables through the building's main façade

R. Actor Isidoro, 11

Net floor area: 77.3m² | Gross floor area: 98.3m²

Original dwelling



Floor plan

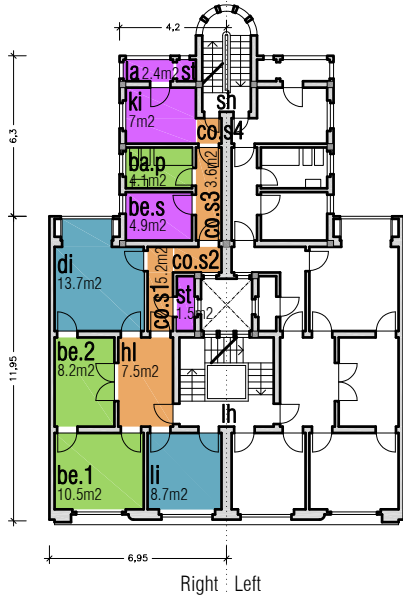

Justified graph

Graph with a tree configuration with 3 rings
 Graph with 8 levels of depth
 15 spaces/nodes
 17 arcs/connections

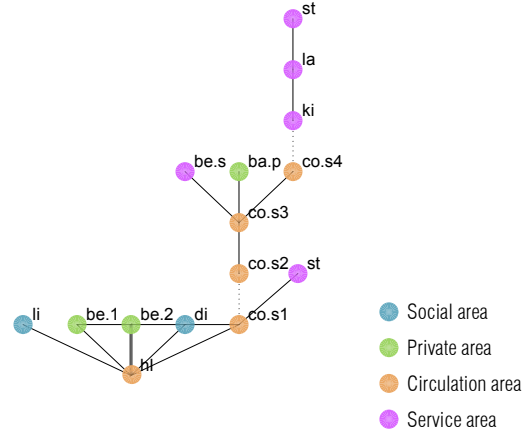

Convex map

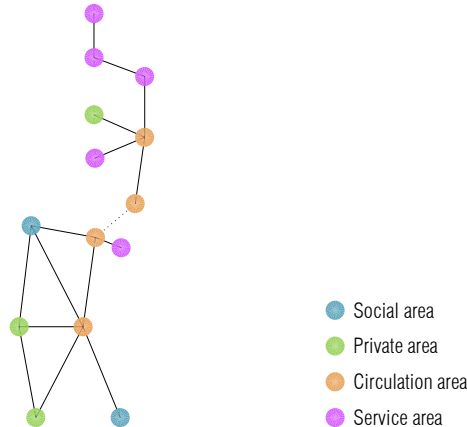

Distributness

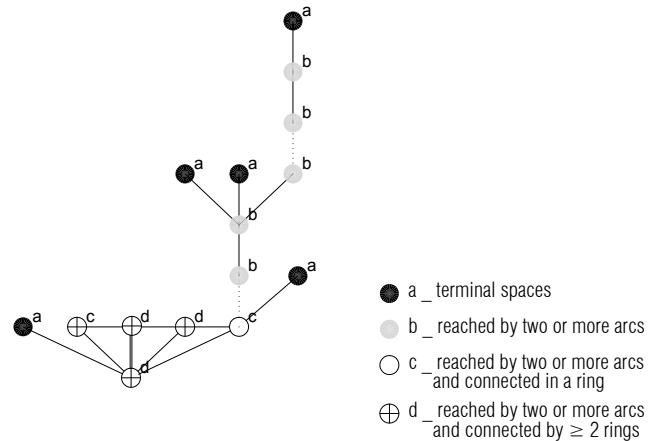

Controle

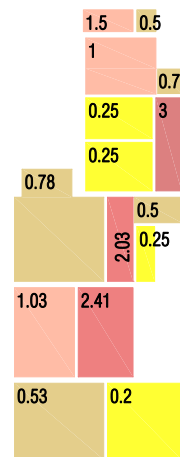

Entire dwelling
 Mean: 1.00

Contiguity

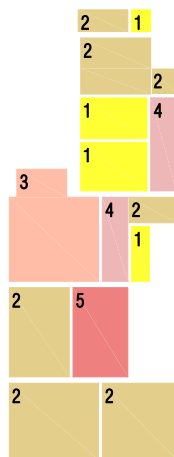

Depth

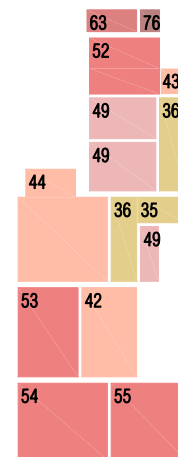

Entire dwelling
 Mean: 46.06

Integration

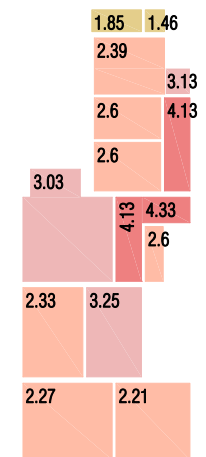

Entire dwelling
 Mean: 2.82





Front façade

Date: 1943
Number of floors: 4
Project authorship: Eng. Jacinto Bethencourt



Door of the building



Building entrance hall



Brief functional characterization

Access One access to the building; two staircases.
Number of dwellings 8
Non habitable divisions Condominium store-rooms
 Caretaker's home

Brief constructional characterization

Structure and foundations Foundations made of concrete up to ground level. Load-bearing stone masonry and cement blocks masonry.
Exterior walls (façades and side walls) Main façade made of stone masonry with cement mortar. Rear façade and side walls made of cement blocks with cement mortar. The walls of the basement are made of cement blocks with thickness of 0.6m
Interior walls Partition walls - hollow stretcher bond brick masonry using cement mortar: ground floor, 1st floor and kitchen and bathroom walls – solid stretcher bond brick masonry; ground floor and 1st floor when walls are non load-bearing – hollow stretcher bond brick masonry; ground floor and 1st floor when walls are load-bearing – solid header bond brick masonry; 2nd and 3rd floor - hollow stretcher bond brick masonry.

Discrepancies, changes in the façade

Several air condition devices mounted on the façade. Cables through the building's main façade.

R. Actor Isidoro, 16

Net floor area: 99.1m² | Gross floor area: 125.5m²

type **d**

Original dwelling



Floor plan

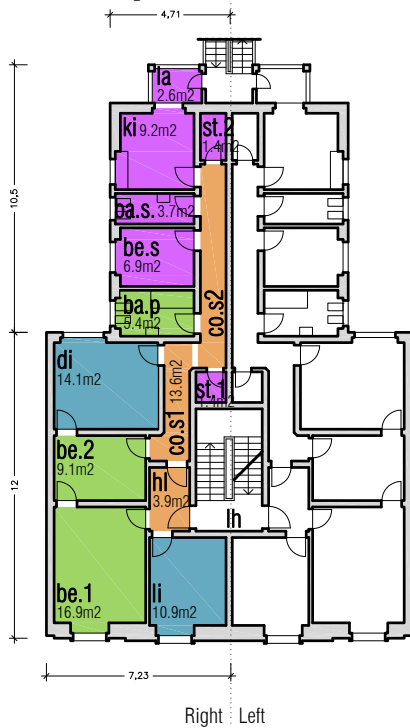

Justified graph

Graph with a tree configuration with 2 rings
Graph with 5 levels of depth
14 spaces/nodes
15 arcs/connections

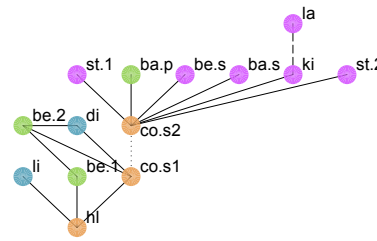

Convex map

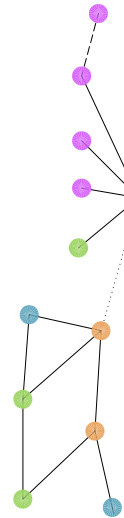

Distributness

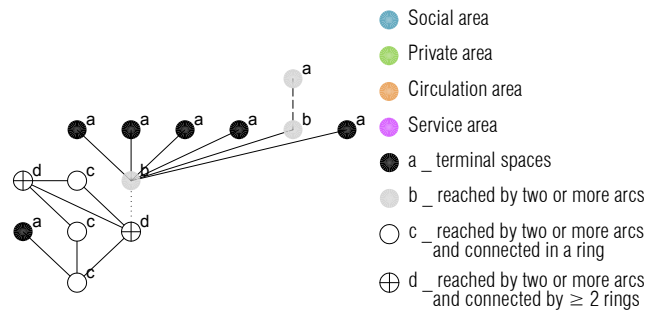

Controle

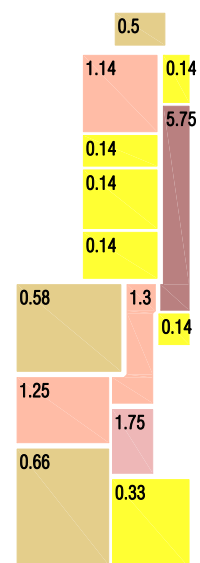

Entire dwelling
Mean: 1.00

Contiguity

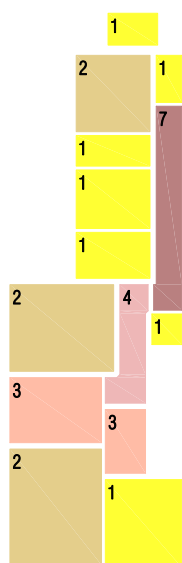

Depth

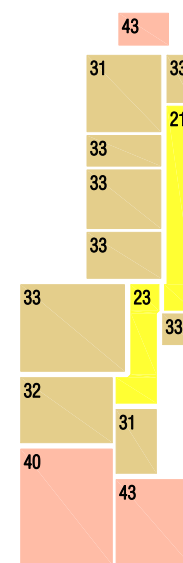

Entire dwelling
Mean: 33.00

Integration

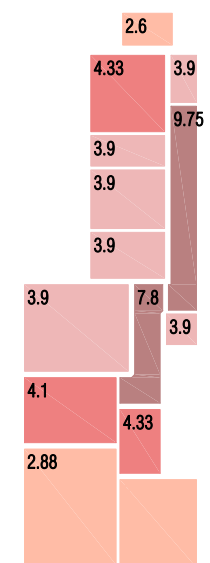

Entire dwelling
Mean: 4.41

Adjacency (arcs)
..... merged — door (single) = door (double) - - - - passage ~ window

Higher Lower 1 2 3 4 5 10



Front façade

Date: 1956

Number of floors: 8

Project authorship: Arch. n.147



Door of the building



Building entrance hall



Brief functional characterization

Access	One access to the building; main lift and service lift, one staircase.
Number of dwellings	16
Non habitable divisions	Caretaker's home

Brief constructional characterization

Structure and foundations	Foundations made of reinforced concrete beneath pillars and continuous foundations beneath dividing walls and exterior walls. Reinforced concrete beam and pillar structure.
Exterior walls (façades and side walls)	Main and rear façade made of reinforced concrete beam and pillar structure filled with two panels of stretcher bonds brick masonry and airspace. Side walls made of continuous reinforced concrete on the ground floor and concrete frame filled with bricks on the remaining floors.
Interior walls	Partition walls made of hollow stretcher brick masonry with cement mortar.

Discrepancies, changes in the façade

One air conditioning device mounted on the façade. Few cables through the building's main façade.

Original dwelling



Floor plan

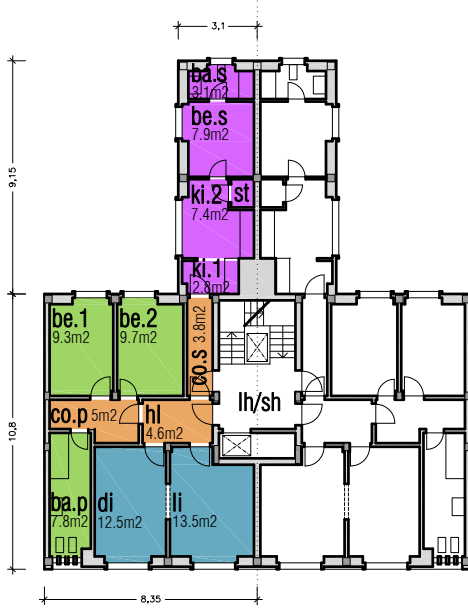

Justified graph

Graph with a tree configuration with 1 ring
 Graph with 6 levels of depth
 13 spaces/nodes
 13 arcs/connections

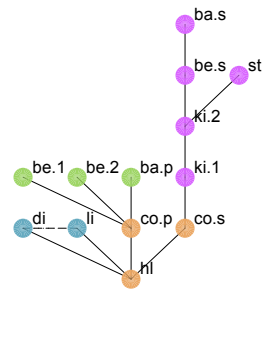

- Social area
- Private area
- Circulation area
- Service area

Convex map

Right : Left

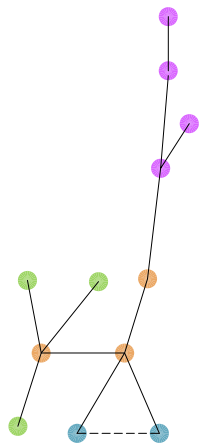

- Social area
- Private area
- Circulation area
- Service area

Distributness

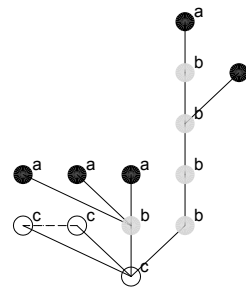

- a _ terminal spaces
- b _ reached by two or more arcs
- c _ reached by two or more arcs and connected in a ring

Controle

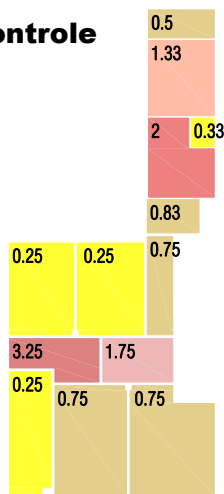

Contiguity

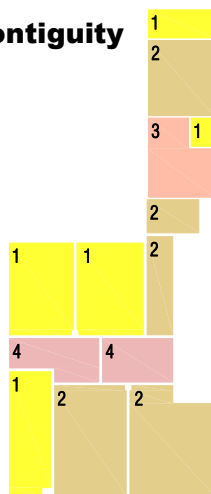

Depth

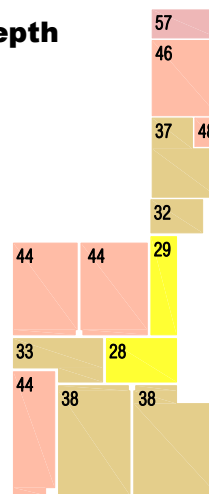

Integration

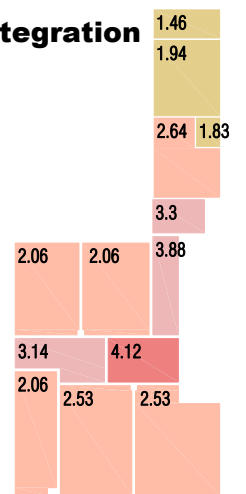

Entire dwelling
 Mean: 1.00

Entire dwelling
 Mean: 39.84

Entire dwelling
 Mean: 2.58

Adjacency (arcs)
 merged ——— door (single) = = = door (double) - - - - passage ~ ~ ~ window

Higher ■ ■ ■ Lower ■ ■ 1 2 3 4 5 10



Front façade

Date: 1949
Number of floors: 7
Project authorship: Arch. Pardal Monteiro



Door of the building



Building entrance hall



Brief functional characterization

Access	Two access to the building; main lift, two staircases.
Number of dwellings	12
Non habitable divisions	Caretaker's home (in the back yard, outside the building) Shops in the ground floor (garage)

Brief constructional characterization

Structure and foundations	Foundations made of reinforced concrete beneath pillars and continuous foundations of hydraulics stone masonry beneath dividing walls. Reinforced concrete beam and pillar structure.
Exterior walls (façades and side walls)	Reinforced concrete structure filled with two panels of hollow stretcher bonds brick masonry and airspace of 0.07m. Side walls made of reinforced concrete, thicknesses of 0.3m on the first three floors and 0.2m on the remaining floors.
Interior walls	Partition walls made of brick masonry – hollow stretcher bond brick masonry on the 5 th and 6 th floor; solid stretcher bond brick masonry on the 3 rd and 4 th floor; double solid stretcher bond brick masonry on the 2 nd floor; solid header bond brick masonry on the ground floor.

Discrepancies, changes in the façade

Original blinds and new ones with different colours (green and white)

Av. João Crisóstomo, 70

(Left) Net floor area: 114.9m² | Gross floor area: 139.7m² (Right) Net floor area: 113.7m² | Gross floor area: 138.1m²

Original dwelling



Floor plan



Justified graph

Graph with a tree configuration
Graph with 5 levels of depth
16 spaces/nodes
15 arcs/connections

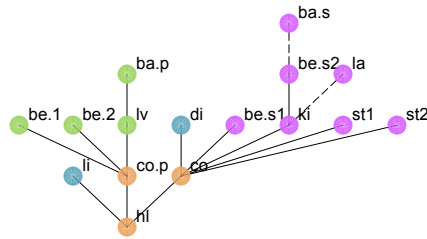

Convex map

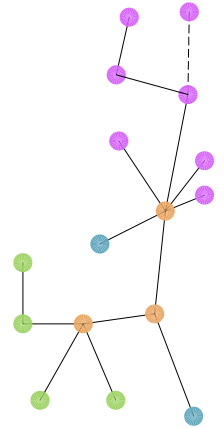

Distributness

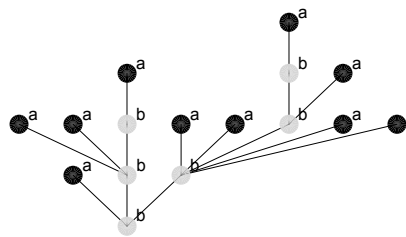

- Social area
- Private area
- Circulation area
- Service area
- a _ terminal spaces
- b _ reached by two or more arcs
- c _ reached by two or more arcs and connected in a ring

Controle

Contiguity

Depth

Integration

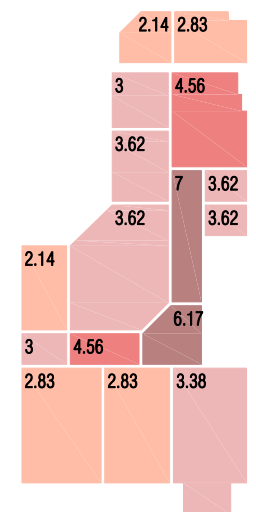
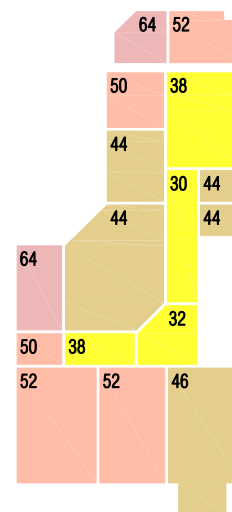
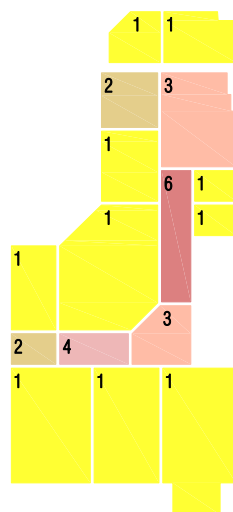
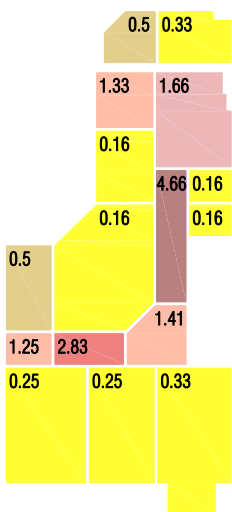

Entire dwelling
Mean: 1.00

Entire dwelling
Mean: 46.50

Entire dwelling
Mean: 3.68

Adjacency (arcs)
..... merged — door (single) = door (double) - - - passage ~ window

Higher Lower
1 2 3 4 5 10



Front façade

Date: 1950
Number of floors: 7
Project authorship: Eng. Jacinto Bethencourt



Door of the building



Building entrance hall

Brief functional characterization

Access One access to the building; main lift, two staircases.
Number of dwellings 12
Non habitable divisions Caretaker's home
 Shops in the ground floor (garage)

Brief constructional characterization

Structure and foundations Foundations beneath the main and rear façade made of simple concrete. Foundations beneath the pillars made of simple concrete or reinforced concrete. Reinforced concrete structure.

Exterior walls (façades and side walls) Main façade made of continuous reinforced concrete. Remaining area of the main façade and rear façade made of reinforced concrete beam and pillar structure filled with two panels of solid stretcher bonds brick masonry and airspace. Side walls made of reinforced concrete.

Interior walls Partition walls made of brick masonry – hollow stretcher bond brick masonry on the 5th and 6th floor; solid stretcher bond brick masonry on the 3rd and 4th floor; double solid stretcher bond brick masonry on the 2nd floor; solid header bond brick masonry on the ground floor.

Discrepancies, changes in the façade

Several cables through the building's main façade. Lack of general maintenance.

Original dwelling



Floor plan

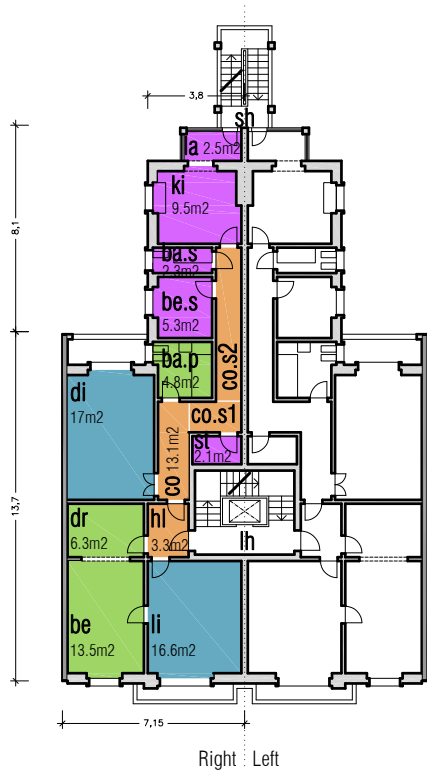

Justified graph

Graph with a tree configuration with 1 rings
 Graph with 6 levels of depth
 14 spaces/nodes
 14 arcs/connections

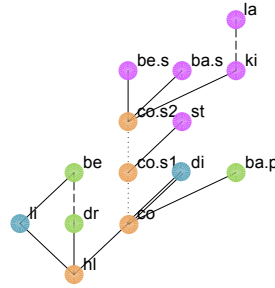

Convex map

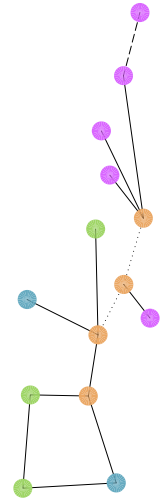

Distributness

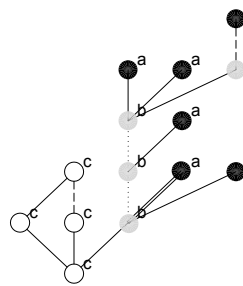

- Social area
- Private area
- Circulation area
- Service area
- a _ terminal spaces
- b _ reached by two or more arcs
- c _ reached by two or more arcs and connected in a ring

Controle

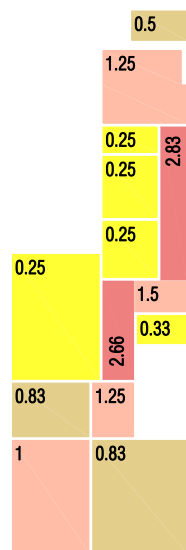

Entire dwelling
 Mean: 1.00

Contiguity

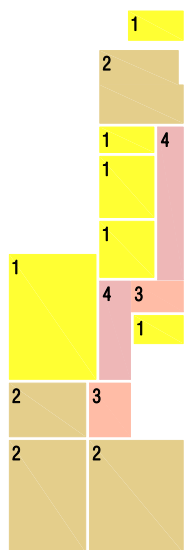

Depth

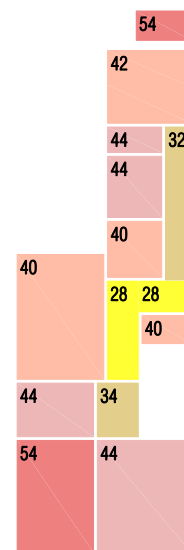

Entire dwelling
 Mean: 40.57

Integration

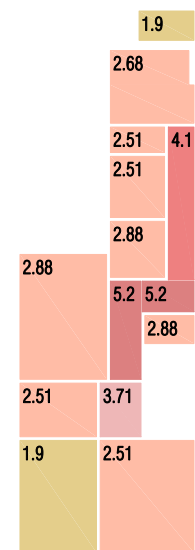

Entire dwelling
 Mean: 3.1

Adjacency (arcs)
 merged — door (single) = door (double) - - - - passage ~ window

Higher Lower 1 2 3 4 5 10



Front façade

Date: 1950

Number of floors: 7

Project authorship: Eng, Ventura Rego



Door of the building



Building entrance hall



Brief functional characterization

Access	One access to the building and one access to the back yard; main lift; two staircases
Number of dwellings	12
Non habitable divisions	Caretaker's home (in the back yard, outside the building) Shops in the ground floor (garage)

Brief constructional characterization

Structure and foundations	Foundations made of stone masonry over clay compacted ground. Foundations are made of concrete beneath pillars (depth superior to 1/2 of the foundation width) and continuous foundations of concrete blocks masonry beneath dividing walls. Reinforced concrete beam and pillar structure.
Exterior walls (façades and side walls)	Concrete structure filled with two panels of stretcher bonds and airspace of 0.08m. Side walls made of continuous reinforced concrete, thickness 0.2m on 4 th , 5 th and 6 th floor, thickness 0.3m on 1 st , 2 nd , 3 rd , ground floor.
Interior walls	Partition walls between divisions: ground floor, 1 st and 2 nd floor - hollow header bond brick masonry; 3 rd , 4 th , 5 th and 6 th - solid header bond brick masonry. Remaining partition walls – brick masonry with cement and sand mortar: ground floor, 1 st and 2 nd floor - double solid header bond brick masonry; 3 rd and 4 th floor – solid stretcher bond; 5 th and 6 th floor - hollow stretcher bond.

Discrepancies, changes in the façade

Few cables through the building's main façade

Av. Barbosa du Bocage, 90

Net floor area: 99.3m² | Gross floor area: 122.3m²

type **d**

Original dwelling

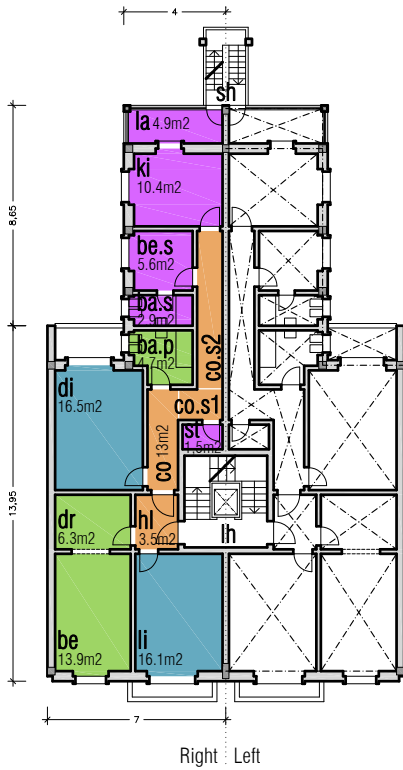

Justified graph

Graph with a tree configuration
Graph with 6 levels of depth
14 spaces/nodes
13 arcs/connections

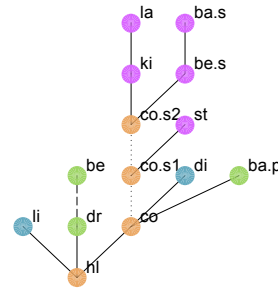

Convex map

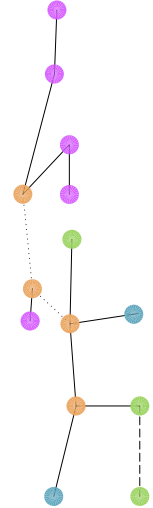

Distributness

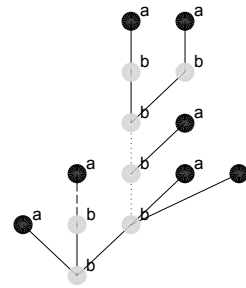

- Social area
- Private area
- Circulation area
- Service area
- a _ terminal spaces
- b _ reached by two or more arcs
- c _ reached by two or more arcs and connected in a ring

Controle

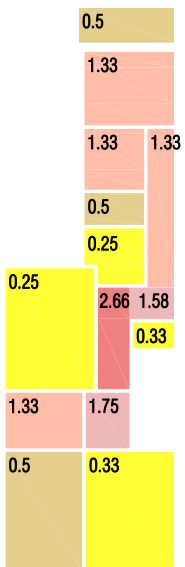

Entire dwelling
Mean: 1.00

Contiguity

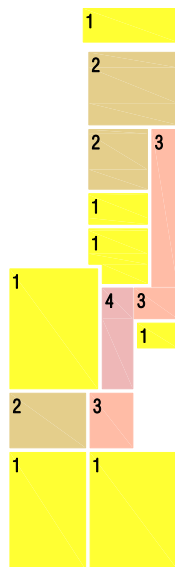

Depth

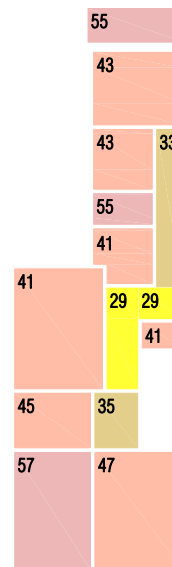

Entire dwelling
Mean: 42.42

Integration

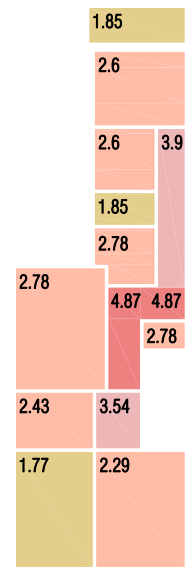

Entire dwelling
Mean: 2.92

Adjacency (arcs)
 merged — door (single) = door (double) - - - - passage ~ window

Higher ■ ■ ■ Lower

1 2 3 4 5 10



Front façade

Date: 1942
Number of floors: 7
Project authorship: Arch. Miguel Jacobetty



Door of the building



Building entrance hall



Brief functional characterization

Access	One access to the building; two staircases.
Number of dwellings	12
Non habitable divisions	Caretaker's home Shops in the ground floor

Brief constructional characterization

Structure and foundations	Foundations made of concrete. Reinforced concrete structure.
Exterior walls (façades and side walls)	Main and rear façade made of concrete structure, thickness 0.5m. Reinforced concrete beams on all the floors. Side walls made of reinforced concrete, thickness from 0.2 on the upper floor to 0.4m on the basement.
Interior walls	Partition walls made of brick masonry.

Discrepancies, changes in the façade

Few cables through the building's main façade. Several air conditioning devices mounted on the main façade.

Av. António Augusto de Aguiar, 9 (1/3)

(Left) Net floor area: 213.1m² | Gross floor area: 265.6m² (Right) Net floor area: 198m² | Gross floor area: 247.1m²

type a

Original dwelling



Floor plan

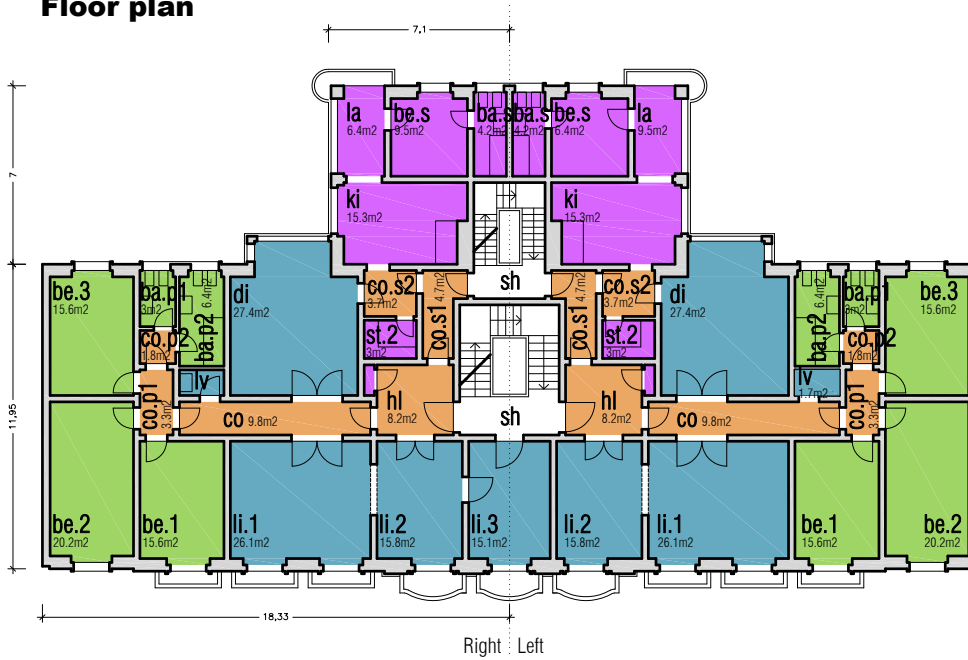

Justified graph

Graph with a tree configuration with 2 rings
 Graph with 6 levels of depth
 22 spaces/nodes
 23 arcs/connections

Right

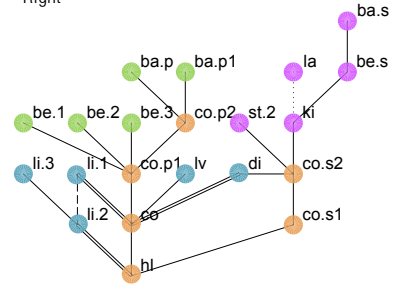

Graph with a tree configuration with 2 rings
 Graph with 6 levels of depth
 21 spaces/nodes
 22 arcs/connections

Left

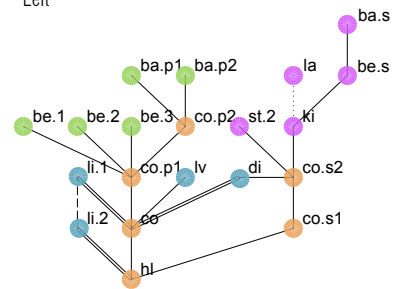

Distributness

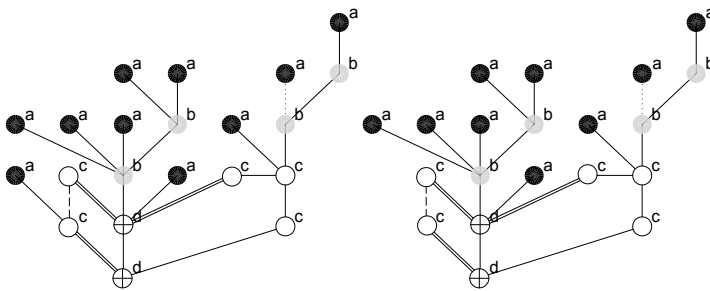

Convex map

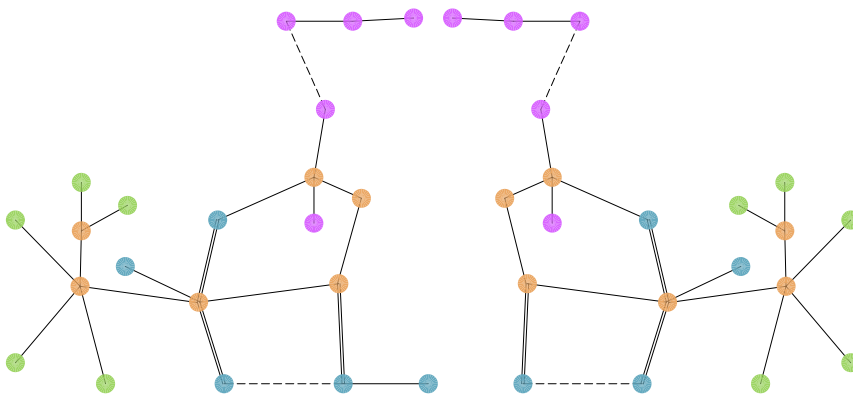

- Social area
- Private area
- Circulation area
- Service area
- a _ terminal spaces
- b _ reached by two or more arcs
- c _ reached by two or more arcs and connected in a ring
- ⊕ d _ reached by two or more arcs and connected by ≥ 2 rings



Av. António Augusto de Aguiar, 9 (2/3)

(Left) Net floor area: 213.1m² | Gross floor area: 265.6m² (Right) Net floor area: 198m² | Gross floor area: 247.1m²

type **a**

Original dwelling



Controle

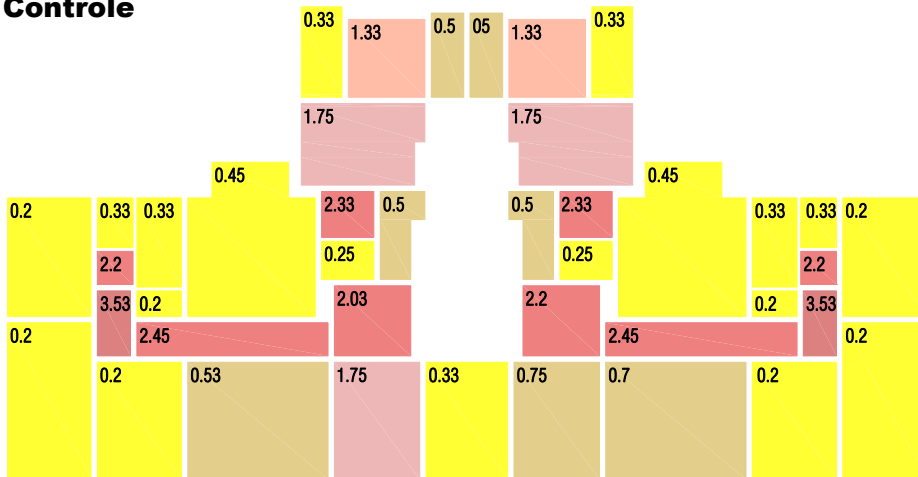

Entire dwelling
Mean: 1.00

Entire dwelling
Mean: 1.00

Contiguity

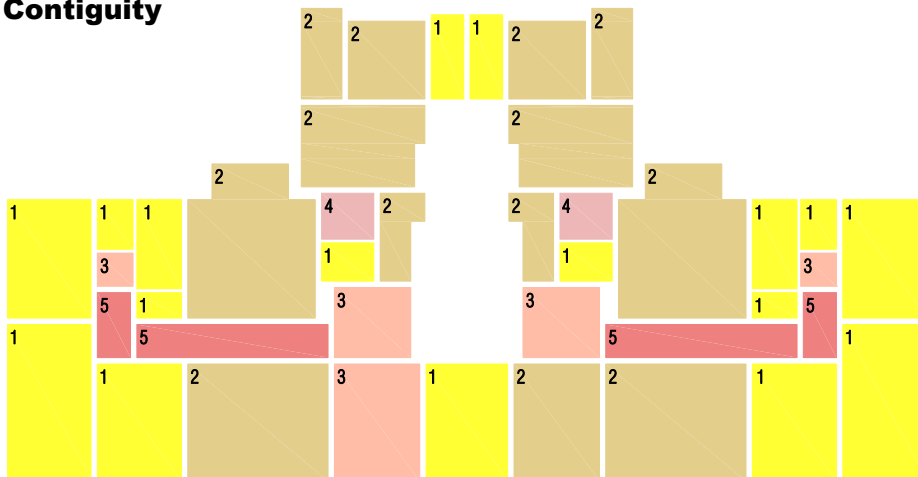

Depth

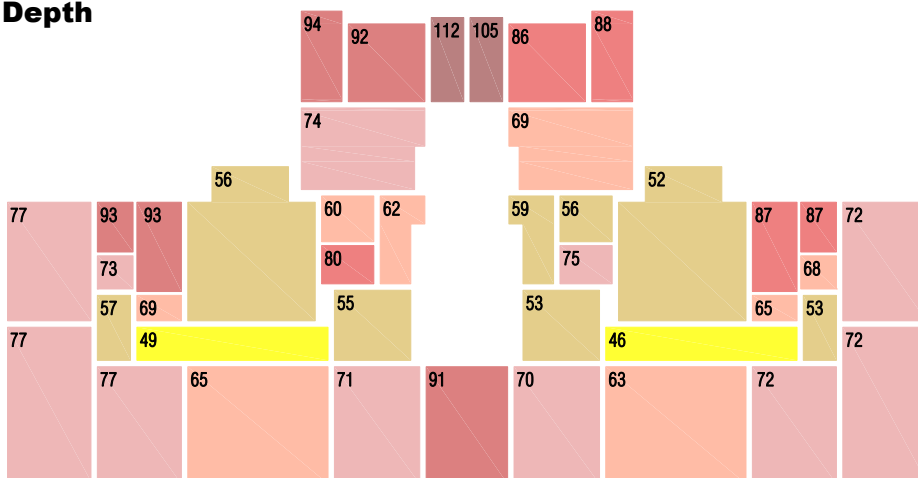

Entire dwelling
Mean: 75.09

Entire dwelling
Mean: 70.00

Adjacency (arcs)
 merged ——— door (single) = = = door (double) - - - - passage ~ ~ ~ window Higher
 Lower 1 2 3 4 5 10

Av. António Augusto de Aguiar, 9 (3/3)

(Left) Net floor area: 213.1m² | Gross floor area: 265.6m² (Right) Net floor area: 198m² | Gross floor area: 247.1m²

Original dwelling



Integration

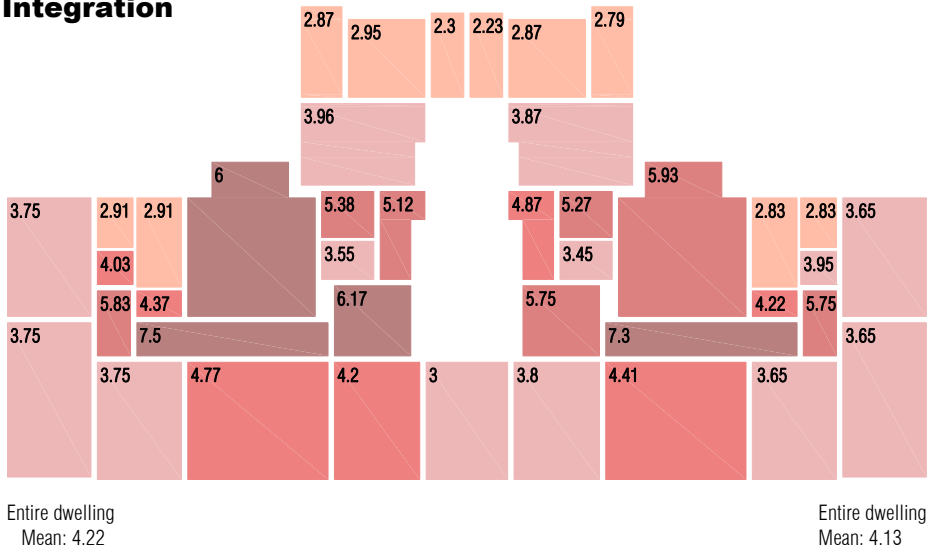



Front façade

Date: c.1949

Number of floors: 4

Project authorship: Arch. Fernando Silva



Door of the building



Building entrance hall

Brief functional characterization

Access	One access to the building. One staircase.
Number of dwellings	6
Non habitable divisions	Shops in the ground floor

Brief constructional characterization

Structure and foundations	-
Exterior walls (façades and side walls)	-
Interior walls	-

Discrepancies, changes in the façade

Replacement of the windows in several floors with different designs. Double window frames resulting in a more advance window surface with aesthetic impact on the main façade. One closed balcony by glass windows. Air conditioning unit on the façade. Shops with alteration of the original openings. Few cables through the building's main façade.

R. José d'Esaguy, 7 (Type 4 from the *célula 3* of *Bairro de Alvalade*)

Net floor area: 84.2m² | Gross floor area: 107m²

type **a**

Original dwelling



Floor plan



Justified graph

Graph with a tree configuration with 1 ring
 Graph with 4 levels of depth
 14 spaces/nodes
 14 arcs/connections

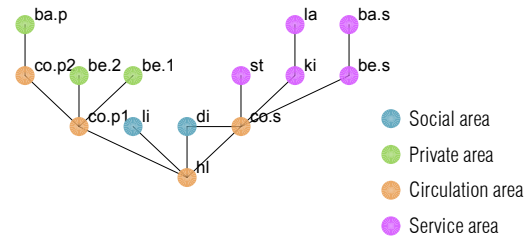

Convex map

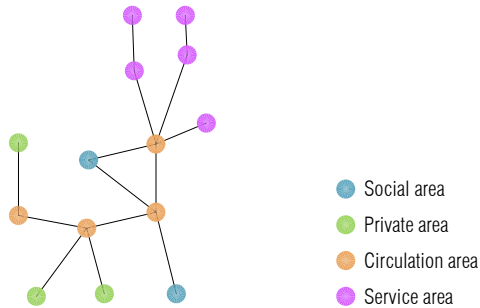

Distributness

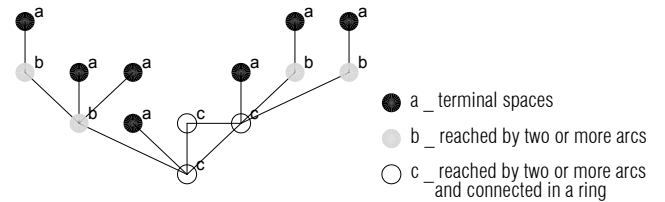

Controle

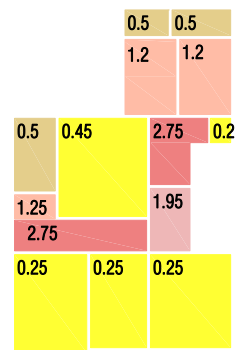

Entire dwelling
 Mean: 1,00

Contiguity

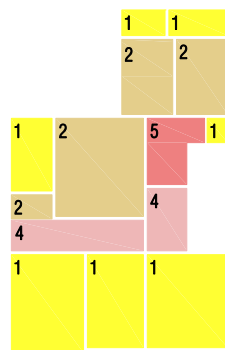

Depth

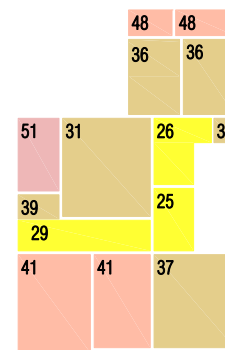

Entire dwelling
 Mean: 37,57

Integration

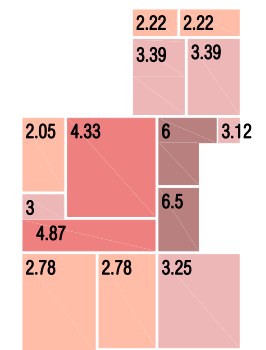

Entire dwelling
 Mean: 3.56





Front façade

Date: 1947

Number of floors: 5

Project authorship: Eng. Jacinto Bethencourt



Door of the building



Building entrance hall



Brief functional characterization

Access	One access to the building; main lift, two staircases.
Number of dwellings	8
Non habitable divisions	Caretaker's home (in the back yard) Shops in the ground floor (garage)

Brief constructional characterization

Structure and foundations	Foundations made of simple concrete upon compacted clay ground. Reinforced concrete structure.
Exterior walls (façades and side walls)	Main and rear façades made of continuous reinforced concrete on the ground floor, thickness 0.5m. From the 1 st floor up these façades are made of reinforced concrete beam and pillar structure filled with two panels of stretcher bonds and airspace. Side walls made of continuous reinforced concrete.
Interior walls	Partition walls made of brick masonry with cement mortar: on the 3 rd and 4 th floor made of hollow stretcher bond brick masonry; on the 1st and 2nd floor made of solid stretcher bond brick masonry; partition walls between stores in the ground floor made of solid header bond brick masonry; partition walls between different dwellings and staircase made of solid stretcher bond brick masonry on the ground floor (hollow brick above the ground floor).

Discrepancies, changes in the façade

One air conditioning device mounted on the façade. Several advertisement structures of large dimensions mounted on the façade.

Original dwelling



Floor plan



Justified graph

Graph with a tree configuration with 1 ring
 Graph with 8 levels of depth
 18 spaces/nodes
 18 arcs/connections

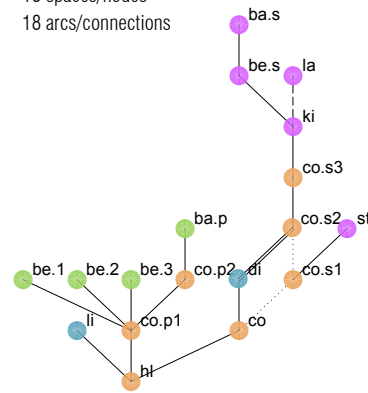

Convex map

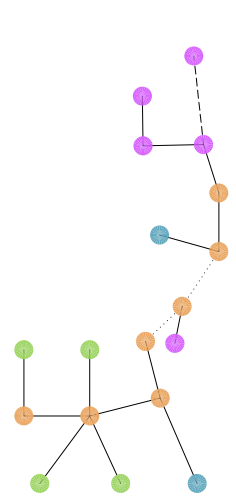

Distributness

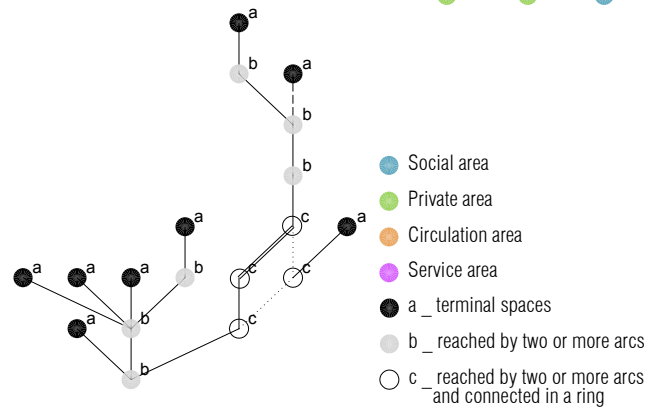

Controle

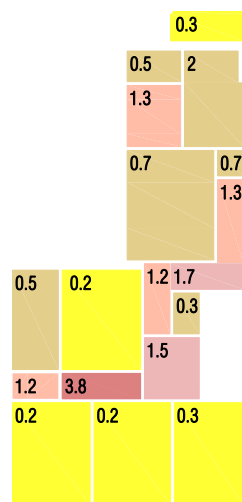

Entire dwelling
 Mean: 1.00

Contiguity

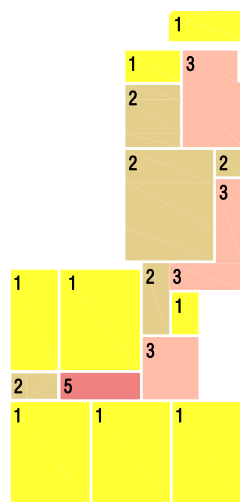

Depth

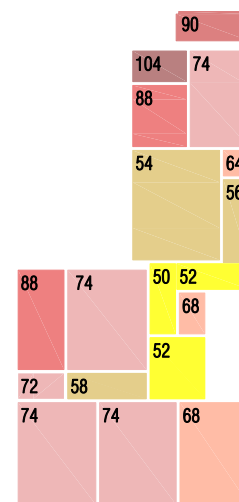

Entire dwelling
 Mean: 70

Integration

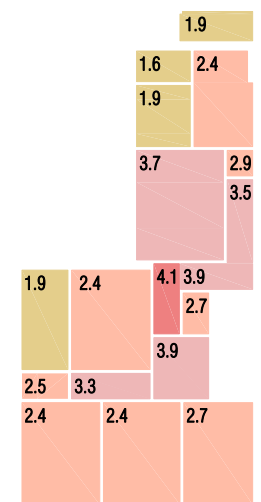

Entire dwelling
 Mean: 2.8





Front façade

Date: 1951
Number of floors: 4
Project authorship: Eng.n.92 (illegible signature)



Door of the building



Building entrance hall



Brief functional characterization

Access One access to the building; one staircase.
Number of dwellings 7
Non habitable divisions Caretaker's home
 Shops in the ground floor

Brief constructional characterization

Structure and foundations Foundations made of hydraulic stone masonry with cement and sand mortar. Reinforced concrete beam and pillar structure on the main and rear façade.
Exterior walls (façades and side walls) Main and rear façades made of concrete structure filled with two panels of stretcher bonds and airspace of 0.1m, thicknesses of 0.4m. Side walls made of concrete structure filled with concrete blocks with a water repellent product coating.
Interior walls Partition walls made of brick masonry with cement and sand mortar: 2nd and 3rd floor in hollow stretcher bond brick masonry, ground floor and 1st floor in solid stretcher bond brick masonry, thickness 0.15m.

Discrepancies, changes in the façade

Replacement of the windows in several floors with different designs. Few cables through the building's main façade. Changes on the façade design on the ground floor in the area occupied by stores. Gas infra-structure mounted on the ground floor façade.

Estrada de Benfica, 490

(Left) Net floor area: 68m² | Gross floor area: 85.3m² (Right) Net floor area: 75.8m² | Gross floor area: 95m²

type **d**

Original dwelling



Floor plan

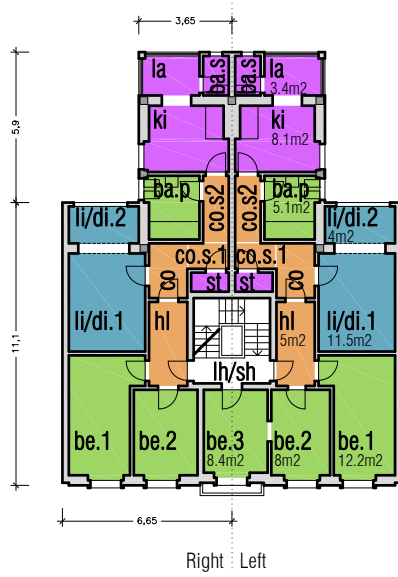

Justified graph

Graph with a tree configuration
Graph with 7 levels of depth
13 spaces/nodes
12 arcs/connections

Right

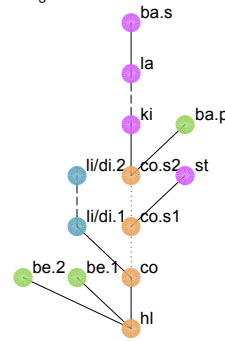

Graph with a tree configuration
Graph with 7 levels of depth
14 spaces/nodes
13 arcs/connections

Left

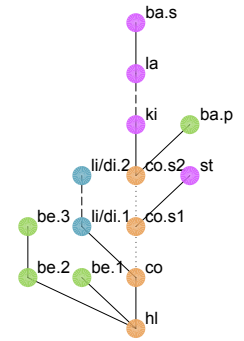

● Social area ● Private area ● Circulation area ● Service area

Convex map

Right Left

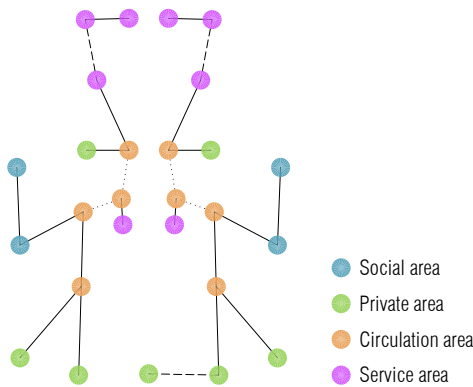

Distributness

Right

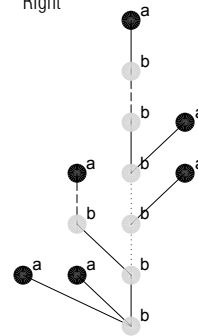

● a _ terminal spaces
● b _ reached by two or more arcs

Left

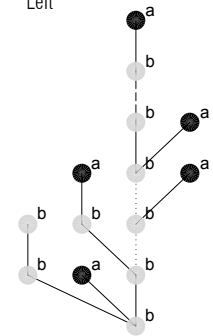

○ c _ reached by two or more arcs and connected in a ring

Controle

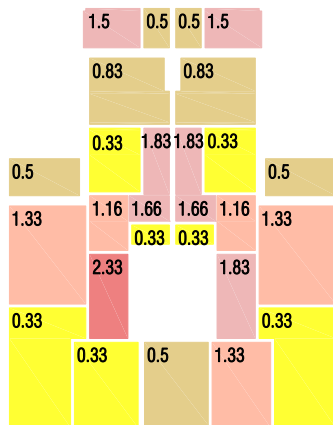

Entire dwelling Mean: 1.00

Contiguity

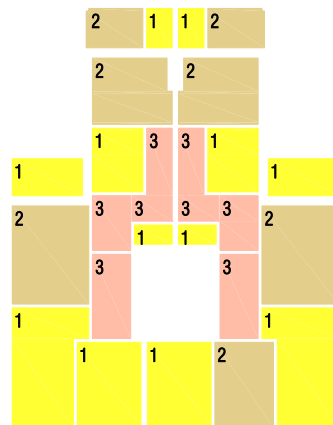

Entire dwelling Mean: 1.00

Depth

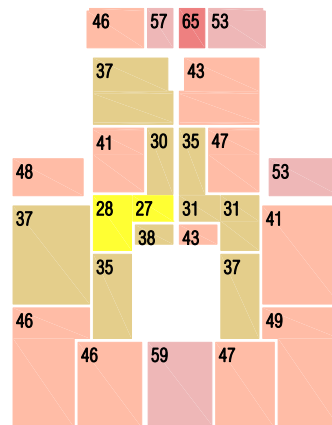

Entire dwelling Mean: 39.69

Integration

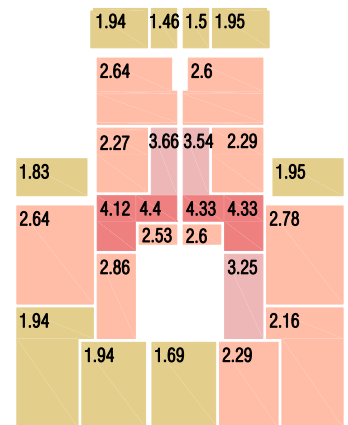

Entire dwelling Mean: 2.63

Adjacency (arcs): merged — door (single) = door (double) - - - - - passage ~ window Higher Lower 1 2 3 4 5 10



Front façade

Date: 1945

Number of floors: 4

Project authorship: -



Door of the building



Building entrance hall



Brief functional characterization

Access	One access to the building; two staircases.
Number of dwellings	7
Non habitable divisions	Caretaker's home

Brief constructional characterization

Structure and foundations	-
Exterior walls (façades and side walls)	Main and rear walls made of ordinary stone masonry with cement and sand mortar. Side walls made of cement and sand blocks.
Interior walls	Partition walls made of brick masonry.

Discrepancies, changes in the façade

Air conditioning devices mounted on the main façade of the building

R. Bica do Marquês, 7

Net floor area: 78m² | Gross floor area: 88.8m²

Original dwelling



Floor plan

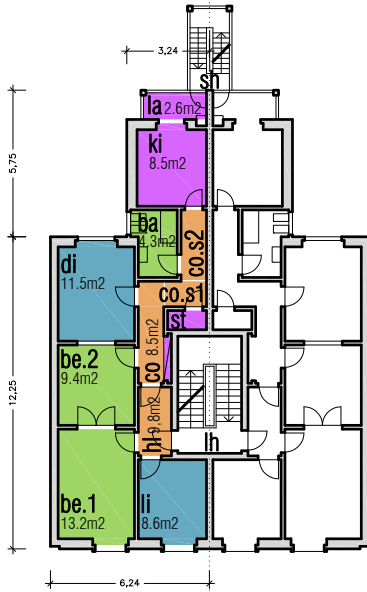

Right Left

Convex map

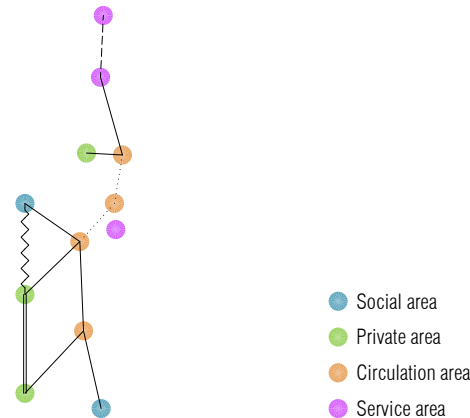

Justified graph

Graph with a tree configuration with 1 ring
 Graph with 6 levels of depth
 12 spaces/nodes
 12 arcs/connections
 (windows connections are excluded)

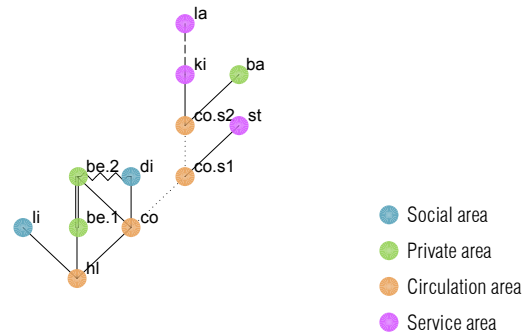

Distributness

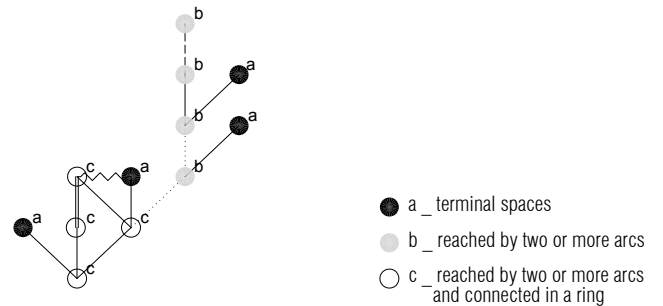

Controle

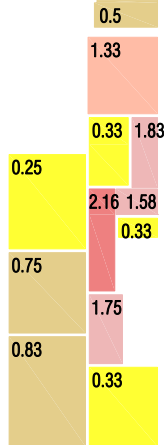

Entire dwelling
 Mean: 1.00

Contiguity

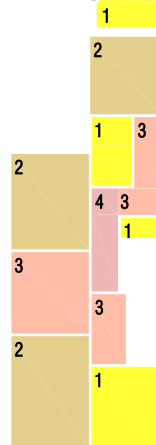

Depth

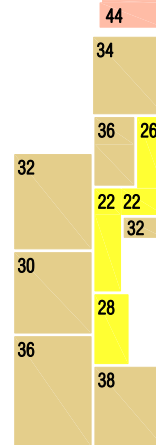

Entire dwelling
 Mean: 31.66

Integration

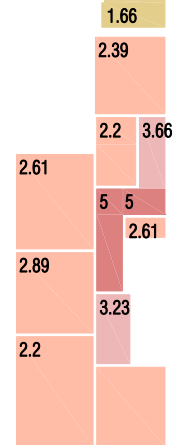

Entire dwelling
 Mean: 2.96





Front façade

Date: 1948

Number of floors: 4

Project authorship: Eng. n.220 (illegible signature)



Door of the building



Building entrance hall



Brief functional characterization

Access	One access to the building; one staircase.
Number of dwellings	7
Non habitable divisions	Condominium store-rooms Caretaker's home Shops in the ground floor

Brief constructional characterization

Structure and foundations	Foundations made of concrete with 0.5m height and above made of hydraulic stone masonry with cement and sand mortar. Main façade made of stone masonry, rear façade and side walls made of concrete blocks with cement and sand mortar.
Exterior walls (façades and side walls)	Main façade thickness: ground floor 0.7m; 1 st floor 0.6m; 2 nd floor 0.5m; 3 rd floor 0.4m. Rear façade thickness: ground floor 0.5m; 1 st floor 0.4m; 2 nd floor 0.4m; 3 rd floor 0.3m. Side walls thickness: 3 rd floor 0.2m, remaining floors 0.3m.
Interior walls	Partition walls made of brick masonry thickness: ground floor and 1st floor 0.15m; 2nd and 3rd floor 0.1m.

Discrepancies, changes in the façade

Several cables through the building's main façade.

Calçada do Galvão, 58

(Left) Net floor area: 59.8m² | Gross floor area: 75.6m² (Right) Net floor area: 58m² | Gross floor area: 74m²

type **b**

Original dwelling

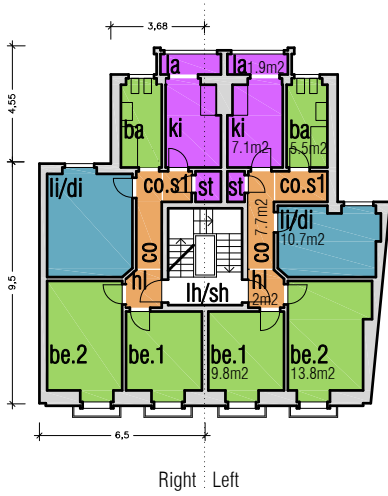

Justified graph

Graph with a tree configuration
Graph with 5 levels of depth
10 spaces/nodes
9 arcs/connections

Right

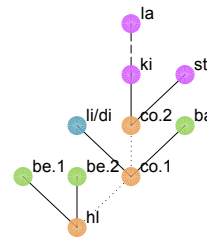

Graph with a tree configuration
Graph with 4 levels of depth
10 spaces/nodes
9 arcs/connections

Left

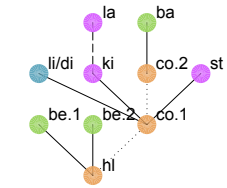

● Social area ● Private area ● Circulation area ● Service area

Convex map

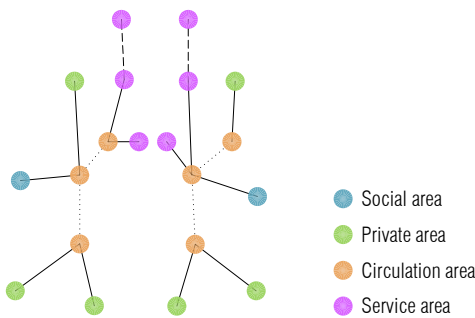

Distributness

Right

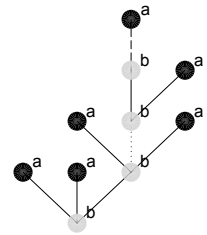

Left

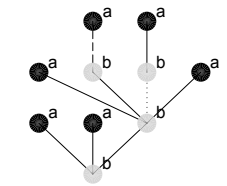

● a _ terminal spaces
● b _ reached by two or more arcs
○ c _ reached by two or more arcs and connected in a ring

Controle

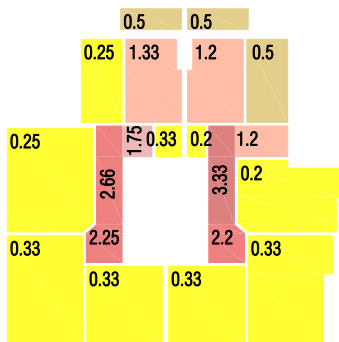

Contiguity

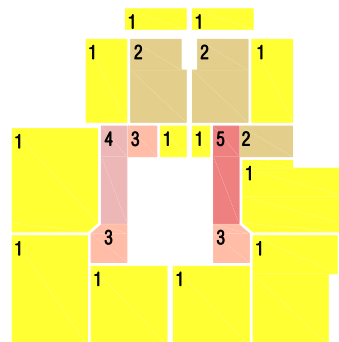

Depth

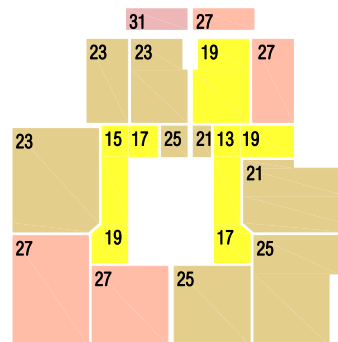

Integration

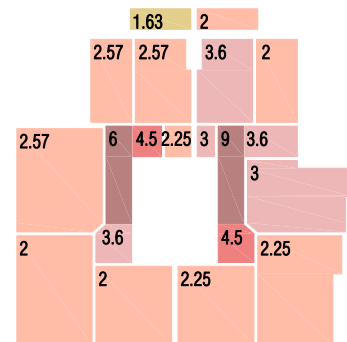

Entire dwelling
Mean: 1.00 (right) / 1.00 (left)

Entire dwelling
Mean: 23 (right) / 21.04 (left)

Entire dwelling
Mean: 2.97 (right) / 3.52 (left)

Adjacency (arcs): merged (dotted), door (single) (solid), door (double) (thick solid), passage (dashed), window (wavy).
Higher/Lower color scale: Higher (dark red) to Lower (yellow).
Scale: 1 2 3 4 5 10



Front façade

Date: 1944
Number of floors: 3
Project authorship: Eng.n.161 (illegible signature)



Door of the building



Building entrance hall



Brief functional characterization

Access One access to the building; two staircases
Number of dwellings 6
Non habitable divisions -

Brief constructional characterization

Structure and foundations -
Exterior walls (façades and side walls) -
Interior walls -

Discrepancies, changes in the façade

Several cables through the building's main façade.

Calçada do Galvão, 135

Net floor area: 72.7m² | Gross floor area: 91.2m²

Original dwelling



Floor plan

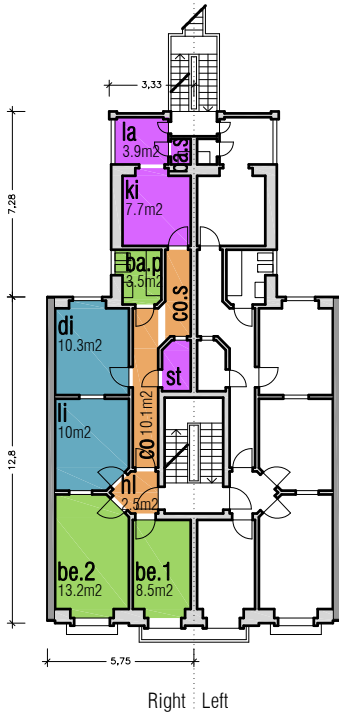

Justified graph

Graph with a tree configuration
Graph with 6 levels of depth
12 spaces/nodes
13 arcs/connections
(windows connections are excluded)

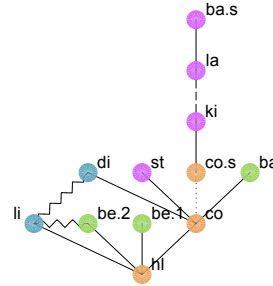

Convex map

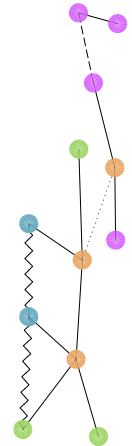

Distributness

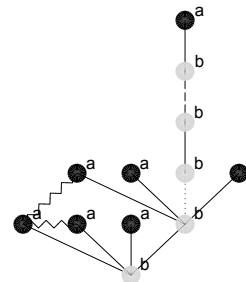

- Social area
- Private area
- Circulation area
- Service area
- a _ terminal spaces
- b _ reached by two or more arcs
- c _ reached by two or more arcs and connected in a ring

Controle

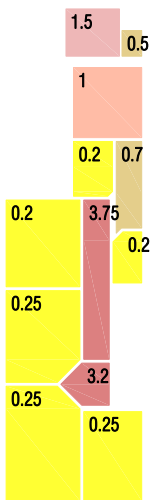

Entire dwelling
Mean: 1.00

Contiguity

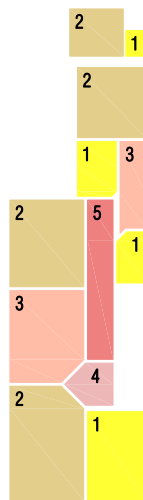

Depth

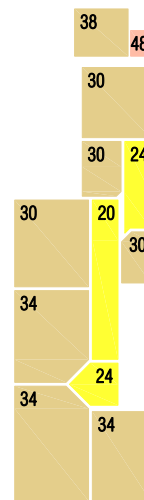

Entire dwelling
Mean: 31.33

Integration

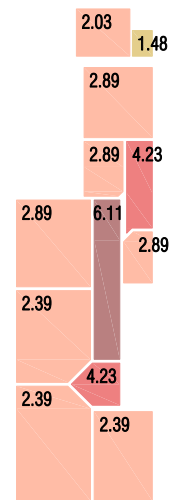

Entire dwelling
Mean: 3.07

Adjacency (arcs)
..... merged — door (single) = door (double) - - - - passage ~ window

Higher Lower 1 2 3 4 5 10



Front façade

Date: 1948

Number of floors: 5

Project authorship: -



Door of the building



Building entrance hall



Brief functional characterization

Access	One access to the building; main lift, two staircases.
Number of dwellings	8
Non habitable divisions	Caretaker's home Shops in the ground floor

Brief constructional characterization

Structure and foundations	-
Exterior walls (façades and side walls)	-
Interior walls	-

Discrepancies, changes in the façade

Some air conditioning devices mounted on the main façade. Some windows frames where changed and replaced by different types of window (original casement windows where replaced by sliding windows). Few cables through the building's main façade.

R. Tomás da Anunciação, 5 [right]

(Left) Net floor area: 121.2m² | Gross floor area: 153.1m² (Right) Net floor area: 106.5m² | Gross floor area: 135.7m²

type **d**

Original dwelling

Floor plan

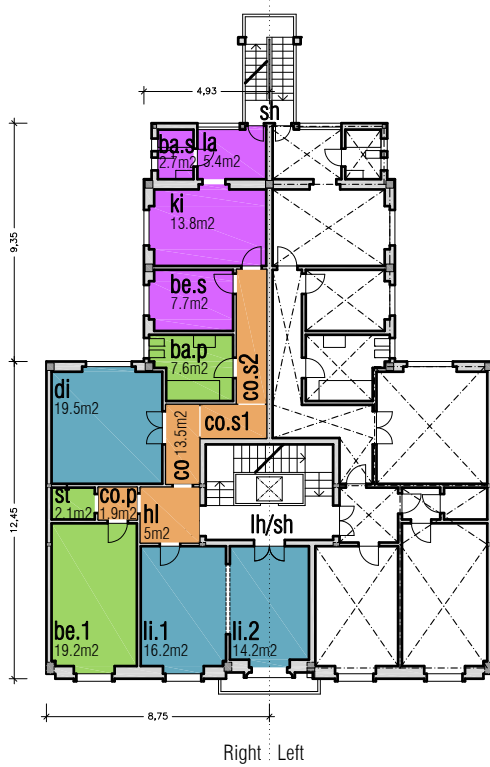

Justified graph

Graph with a tree configuration
Graph with 7 levels of depth
15 spaces/nodes
14 arcs/connections

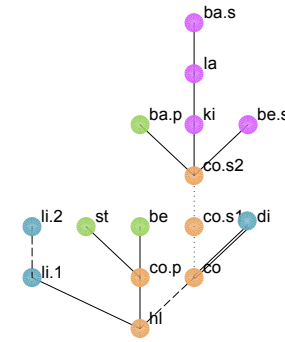

Convex map

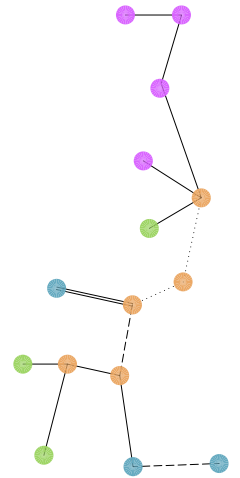

Distributness

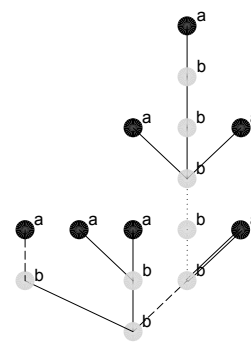

- Social area
- Private area
- Circulation area
- Service area
- a _ terminal spaces
- b _ reached by two or more arcs
- c _ reached by two or more arcs and connected in a ring

Controle

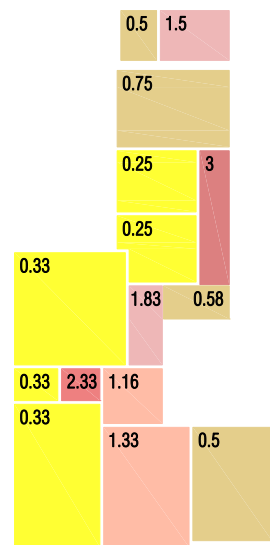

Entire dwelling
Mean: 1.00

Contiguity

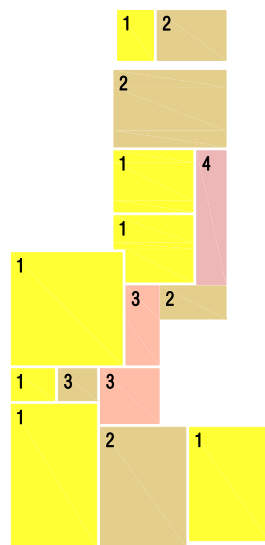

Depth

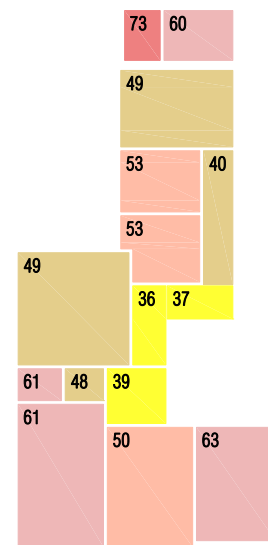

Entire dwelling
Mean: 51.46

Integration

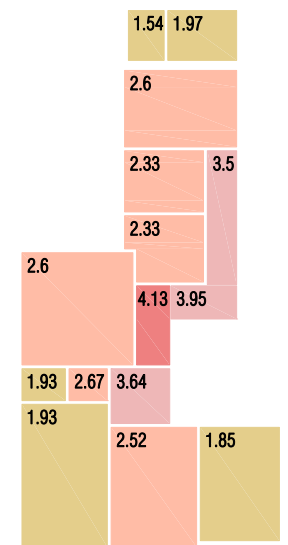

Entire dwelling
Mean: 2.63

Adjacency (arcs)
..... merged — door (single) = door (double) - - - - passage ~ window

Higher Lower
1 2 3 4 5 10

R. Tomás da Anunciação, 5 [left]

(Left) Net floor area: 121.2m² | Gross floor area: 153.1m² (Right) Net floor area: 106.5m² | Gross floor area: 135.7m²

type **d**

Original dwelling

Floor plan

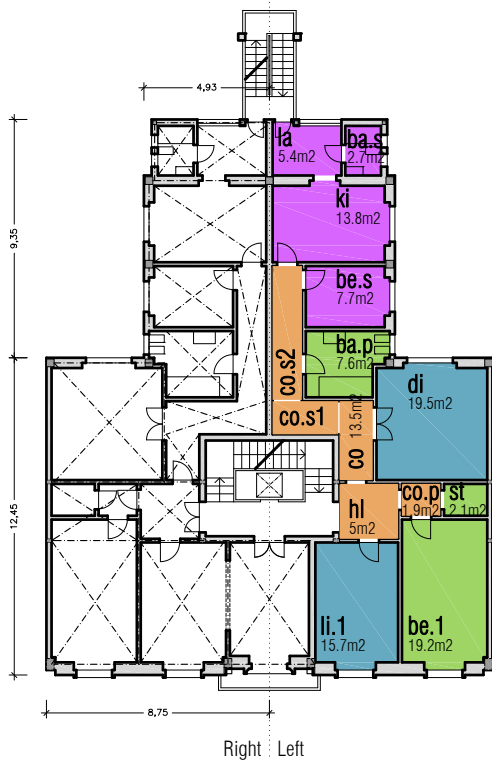

Justified graph

Graph with a tree configuration
Graph with 7 levels of depth
14 spaces/nodes
13 arcs/connections

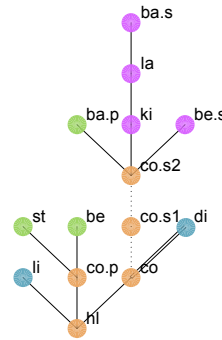

Convex map

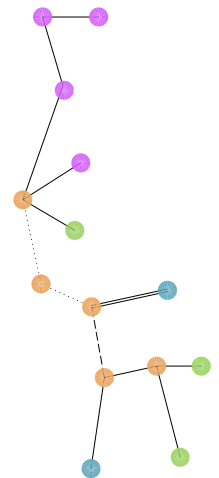

Distributness

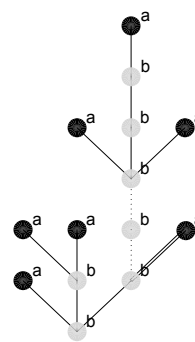

- Social area
- Private area
- Circulation area
- Service area
- a _ terminal spaces
- b _ reached by two or more arcs
- c _ reached by two or more arcs and connected in a ring

Controle

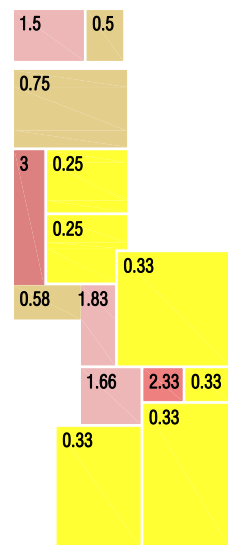

Entire dwelling
Mean: 1.00

Contiguity

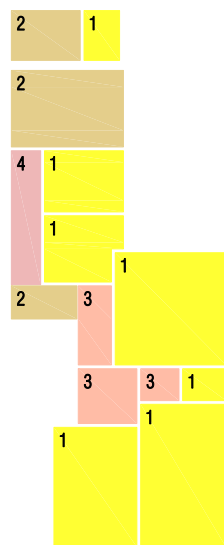

Depth

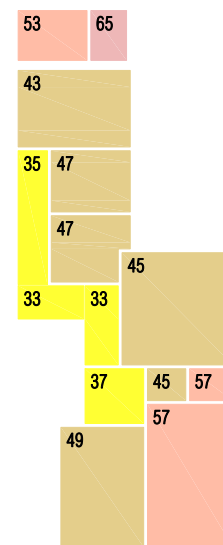

Entire dwelling
Mean: 46.14

Integration

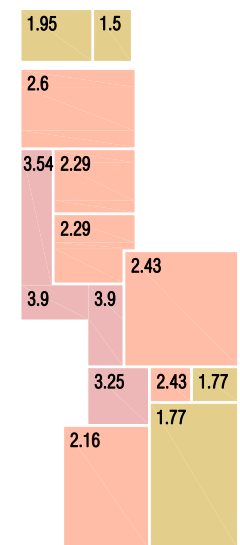

Entire dwelling
Mean: 2.55



APPENDIX 2

Steps 1, 2 and 3 of the experiment

APPENDIX 2: STEPS 1, 2 AND 3 OF THE EXPERIMENT

As stated in *Part 2: Chapter 1.4* the methodology used to infer the transformation grammar was divided into three steps, each corresponding to a particular type of experiment:

- Step 1: testing the feasibility of the experimental setup by the main author of the research and defining a set of preliminary rehabilitation rules that could be transmitted to the experimental subjects in step 2:
- Step 2: finding rehabilitation solutions that could satisfy the functional and constructional requirements of each family in a given dwelling. These solutions, designed by hand, were used to infer transformation rules;
- Step 3: testing the transformation rules inferred in the previous step by verifying whether the solutions generated following these rules were satisfactory.

The goal was to relate domestic groups (families) to dwellings (existing houses). Prior to applying the methodology, data concerning the domestic groups, the case study dwellings, new housing functions, and the pack of ICAT functions was gathered and organised, as described below. These elements were then given to the experimental subjects in steps 1, 2 and 3.

This appendix includes data on these steps that is not cited in the main body of the thesis, namely the data used by the experimental subjects and some examples of the results of the experiment.

DATA USED: FAMILIES AND EXISTING HOUSES

The results of the interviews with the five families are presented in Table 1 to Table 5.

Family 01	Couple with 3 children	Minimal functional programme 1 Double bedroom; 1 Twin bedroom; 1 Single bedroom; 1 Kitchen; 1 Living room; 1 Bathroom (toilet, lavatory, bidet, bath or shower); Storage areas
	Couple	Extra areas or functions in order of priority
	Girl aged 5	Small office space; 2 Private bathrooms (toilet, lavatory, bidet, bath or shower); Large living/dining room ($\geq 12\text{m}^2$ and 18m^2); 1 guest bathroom
	Girl aged 3 Boy aged 1	Important connections between rooms Children's bedrooms near parents' bedroom; Private bathrooms in private area; Living room adjacent to dining room or large combined living/dining room

Table 1 – Results from the interview with family 01

Family 02	Couple with 2 children	Minimal functional programme 1 Double bedroom; 1 Twin bedroom; 1 Kitchen; 1 Living room; 1 Bathroom (toilet, lavatory, bidet, bath or shower); Storage areas
	Couple	Extra areas or functions in order of priority
	Girl aged 8	2 Single bedrooms for children; Living room separated from dining room ($\geq 12\text{m}^2$ and 18m^2); 2 Private bathrooms; 1 guest bathroom; Room for home office which could also be used as a guest bedroom; Laundry room separate from, but near, kitchen
	Girl aged 4	Important connections between rooms Children's bedrooms near parents' bedroom; Private bathroom in private area; Dining room near kitchen; Living room near entrance

Table 2 – Results from the interview with family 02

Family 03	Young couple without children	Minimal functional program 1 Double bedroom; 1 Kitchen; 1 Living room; 1 Bathroom (toilet, lavatory, bidet, bath or shower); Storage areas
	Couple	Extra areas or functions in order of priority
		Home office in an independent room; Big living/dining room ($\geq 25\text{m}^2$); Balcony connected to social area; Extra storage areas; 1 guest bathroom
		Important connections between rooms Private space (bedroom and bathroom) segregated from the rest of the dwelling

Table 3 – Results from the interview with family 03

Family 04	Elderly couple	Minimal functional programme
		1 Double bedroom; 1 Kitchen; 1 Living room; 1 Bathroom (toilet, lavatory, bidet, bath or shower); Storage areas
	Couple 2 grandsons (occasionally)	Extra areas or functions in order of priority
		1 Twin bedroom for grandsons (occasional use); Small office space; Dining area in kitchen; Living room separate from dining room; 1 guest bathroom
		Important connections between rooms
		Bedrooms next to each other; Guest bathroom in social area; Dining room near kitchen

Table 4 – Results from the interview with family 04

Family 05	Couple with children (second marriage, children from different marriages)	Minimal functional programme
		1 Double bedroom; 1 Twin bedroom; 1 Single bedroom; 1 Kitchen; 1 Living room 1 Bathroom (toilet, lavatory, bidet, bath or shower); Storage areas
	Couple 2 children from mother's previous marriage (girl aged 8, boy aged 10), 1 child from father's previous marriage (boy aged 12)	Extra areas or functions in order of priority
		1 Single bedroom for each child; 2 Private bathrooms; 1 guest bathroom; Extra storage areas; Big living room and dining room (1 or 2 rooms) (dining room $\geq 12m^2$ and living room $\geq 20m^2$)
		Important connections between rooms
		All bedrooms in private area; Children's bedrooms next to each other; Private space (bedrooms and bathrooms) segregated from the rest of the dwelling

Table 5 – Results from the interview with family 05

The criterion for selecting dwellings for the 1st and 2nd steps was to choose ten dwellings of varying types and areas that could potentially meet the requirements of the functional programmes for the selected families (Table 6).

The 10 chosen dwellings corresponded to 3 "type A" dwellings, 2 "type B" dwellings 2 "type C" dwellings and 3 "type D" dwellings (see Figure 1 and Table 7).

For the third step, three different dwellings were chosen that were not used in the 1st and 2nd experiments.

Family	Recommended number of bedrooms (minimal)	<i>Rabo-de-bacalhau</i> (selected types)			
		A	B	C	D
Family 01	Couple with 3 children	3			
Family 02	Couple with 2 children	2			
Family 03	Young couple without children	1	*		*
Family 04	Elderly couple alone	1	*		*
Family 05	Couple with 3 children from different marriages	3			

Compatible types

* The types indicated are unsuitable for the size of the family. These dwellings may correspond to the functional programme if divided into two different dwellings.

Table 6 – Correspondence between selected dwellings and family size. 1st and 2nd steps of the experiments.

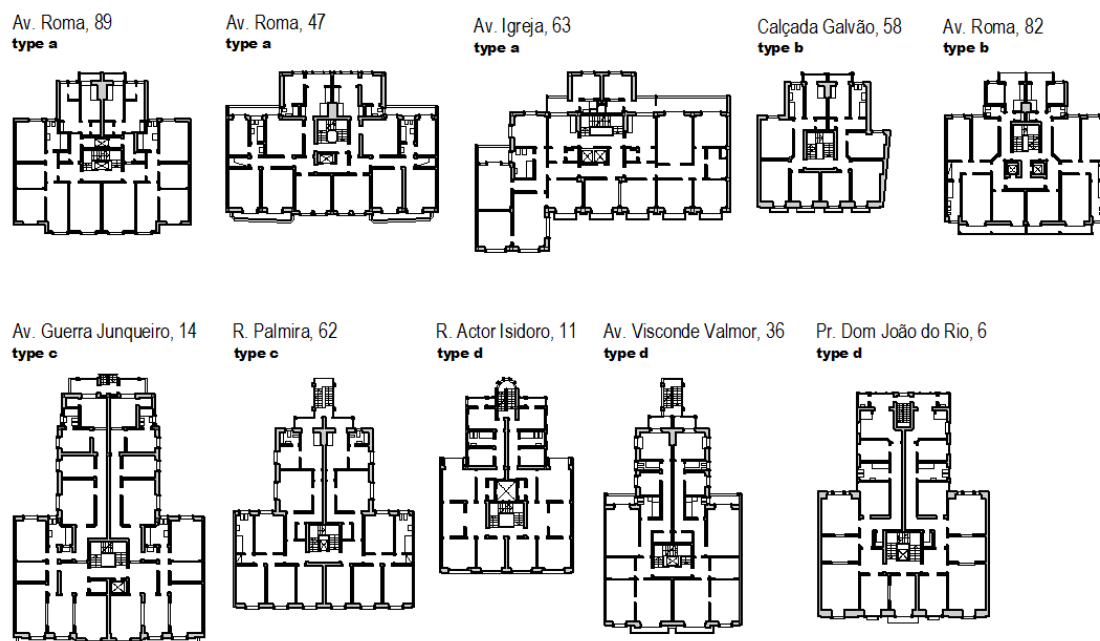

Figure 1 – Dwellings selected for the 1st and 2nd step of the experiment.

Divisions	Family 1		Family 2		Family 3		Family 4		Family 5	
	2+3 people 3 bedrooms		2+2 people 3 bedrooms		2 people 1/2 bedrooms		2 people 2 bedrooms		2+3 people 4 bedrooms	
	minimum	recom.	minimum	recom.	minimum	recom.	minimum	recom.	minimum	recom.
Double bedroom	10.5	12	10.5	12	10.5	12	10.5	12	10.5	12
Twin bedroom	9	14.5	-	-	-	-	9	14.5	-	-
Single bedroom	6.5	8.5	13	17	-	-	-	-	19.5	25.5
Living room	18	16	16	16	25	25	12	18.5	20	20
Dining room	12	12	12	12	-	-	-	-	12	12
Media room	-	3	-	3	-	**	-	2	-	-
Kitchen	6	10.5	6	10.5	6	9	6	9	6	11.5
Laundry	2	3.5	2	3.5	2	3.5	2	3.5	2	3.5
Private bathroom 1	3.5	5	3.5	5	3.5	5	3.5	5	3.5	5
Private bathroom 2	1	2	1	2	-	-	-	-	2.5	3
Guest bathroom	-	1	-	1	1	2	1	2	1	2
Storage	4	4	3.75	3.75	3.25	3.25	2.25	2.25	5.25	5.25
Adult work area	2	4	6.5	8.5	2	4	2	4	1	3
Corridor (16%)*	11.92	15.36	11.88	15.08	8.52	10.20	7.72	11.32	13.32	16.44
Net floor area of desired dwelling	86.42	111.36	86.13	109.33	61.77	73.95	57.13	85.55	96.57	119.19
Minimum net floor area of dwelling	72,5	111	66,4	99	44,4	66,1	46	65	77,4	114
Rehabilitated dwellings:										
Hyp.1	97	type a	100,2	type a	96,3	type d	85,1	type b	153,5	type c
Hyp.2	111	type c	120,8	type d	59,8	type b	77,3	type d	121,3	type a
Hyp.3									118,6	type a

Not part of the minimum functional programme but requested by the family

Adequate floor area

Excess floor area

* The circulation area was calculated using the ratio resulting from the case study analysis - 16%

** The additional media room area was not considered, since the living room area was indicated by the residents.

Table 7 – Calculations for the net floor area (m²) for each family based on the minimum values in the functional programme and the needs expressed by each family. Comparison between these values and the net floor area of each of the two dwellings assigned to each family in Steps 1 and 2.

STEP 1

The aim of this first step was to test the rehabilitation hypotheses according to the requirements defined in the functional programme, in addition to the pack of ICAT and the extra requirements specified by each family. As this step was undertaken by the author of the thesis, the information set used was the knowledge of aspects relating to the rehabilitation work acquired up to this stage. The data on the families (the functional programme and ICAT pack) and proposed dwellings was as previously defined.

The procedure for carrying out the experiment, together with the information used and the procedure for assessing the results, was similar to those illustrated in Step 2 (see pages 73 to 80).

STEP 2

In step number 2 the same data from experiment 1 was used, namely, 10 existing dwellings (Figure 1) and 5 different families (Table 1 to Table 5). Besides the dwelling layouts (plotted on a scale of 1:100 or DWG drawing) and the written description of family desires, a brief description of the major functional and constructional aspects the family had to follow was given to the experimental subjects (Figure 3).

The data that resulted from these experiments included sketches (two of the architects designed by computer and therefore did not produce sketches) (Figure 2), final drawings of the proposed layouts, and texts explaining the process followed in each case (two of the architects explained the process verbally and therefore did not write texts.)

Pages 73 to 80 show one example of a pair of family/dwelling transformations produced during Step 1 by experimental subject #1 and during Step 2 by experimental subjects #2a, #2b, #2d and #2e. The first experimental subject proposed three different transformations and all others but one of the experimental subjects proposed only one transformation. The total proposed layouts for this dwelling/family pair was 7. Page 80 shows the evaluation form which was completed for each of the seven layouts in order to assess fulfilment of the functional programme for the dwelling.

A set of forms similar to the sample shown in pages 73 to 79 was completed for each of the 35 resulting dwelling transformations in order to compare them and infer transformation rules.

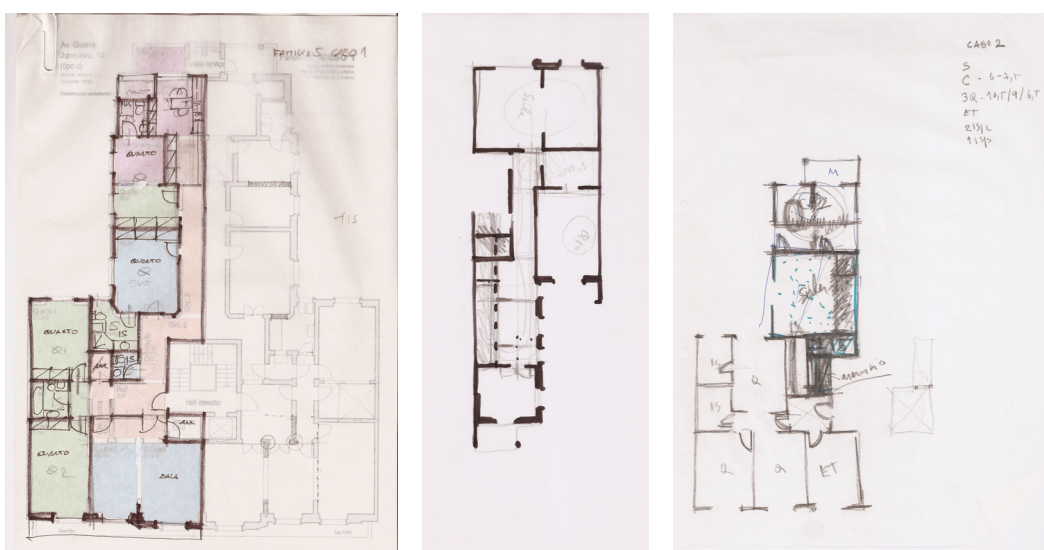

Figure 2 – Drawings produced by the experimental subjects during Step 2 of the experiment

All dwellings must include the following mandatory rooms (MR) and optional rooms (OR). Room net floor areas are shown.			
MR	Kitchen ($\geq 6\text{m}^2$)	OR	Living room (if isolated) ($\geq 10,5\text{m}^2$)
MR	Laundry (can be included in the kitchen) (if apart from kitchen, it must have $\geq 1,5\text{m}^2$)	OR	Dining room (if isolated) (for 2 persons $\geq 7,5\text{m}^2$)
MR	Living and dining room (must include living and dining space for, at least, all the members of the family) (for 2 or 3 people $\geq 18\text{m}^2$, for 4 or 5 people $\geq 20\text{m}^2$)	OR	Guest bathroom ($\geq 1\text{m}^2$)
MR	Private bathroom (toilet, lavatory, bidet, bathtub or shower) ($\geq 3,5\text{m}^2$)	OR	2 nd private bathroom ($\geq 2,5\text{m}^2$)
MR	Bedroom(s) (couple $\geq 10,5\text{m}^2$, double $\geq 9\text{m}^2$, single $\geq 6,5\text{m}^2$)	OR	Home office
Functional areas	Rules		
Social area	<ul style="list-style-type: none"> – Spaces: living room, dining room, home office, social bathroom. – Inhabitable spaces must have natural light and ventilation; – Social area must be near the entrance and permit easy access; – Living and dining rooms must have a proper access to the circulation area or to other living area; – Two separated but connected (living and dining) rooms are recommended, rather than one room; – The living room must be of the appropriate size and have enough space to accommodate the furniture needed for a large TV set or home cinema; – The guest bathroom must be near social and circulation area; access to the social bathroom should not be visible from the entrance; the guest bathroom should not have direct access to living or dining room; 		
Private area	<ul style="list-style-type: none"> – Spaces: Bedroom(s), private bathroom(s) and closet(s) – Inhabitable spaces must have natural light and ventilation. It is permissible for a bedroom not to have natural light or ventilation if it is only used occasionally, in which case it must receive light and ventilation from another adjacent room; – The private area must be the most segregated area of the dwelling; – The circulation area that serves the private area must be separate from the one that serves the social and service areas. The night-time areas (bedrooms + private bathroom) ought to be separated from the daily-time areas (living and dining rooms + kitchen) by doors or hallways. – Bedrooms must have a proper access from a circulation areas or access from a home office or a play room. – Bedrooms must have easy and direct access to private bathroom without crossing social areas; – Connexion between bedrooms and entrance door must be done by one or two circulation spaces apart from living and dining rooms. 		
Service area	<ul style="list-style-type: none"> – Spaces: kitchen, laundry, storeroom; – The kitchen must have natural light and ventilation or light and ventilation via the laundry; – The kitchen must have proper access to the circulation area although it may also have access via a living or dining room (permissible if this is not the only division in the social area) – The kitchen must include an area for informal meals or, alternatively, direct access to the dining room; – The kitchen must be near the laundry and have easy access to it. 		
Circulation area	<ul style="list-style-type: none"> – The circulation area must be reduced and used more efficiently (e.g. by adding closets or enlarging the social area); – Circulation spaces within different areas must not have breaks (e.g. doors between two different private corridors) 		
Demdition / new construction	<ul style="list-style-type: none"> – Rehabilitation work must involve little demolition and only in "surgical" situations. – Entire walls cannot be demolished. Demdition work must obey two rules: the length of the demolished section should be 2m or less and it cannot total more than half the wall; – Beams for new openings must be considered in any demolition work; – Bathrooms can be relocated if this proves to be the best solution (we used maceration technology or a new vertical line of sewage). – New walls must be constructed using a light partition wall system as plasterboard, wood panelling, etc. 		
Floor areas	<ul style="list-style-type: none"> – The criterion of minimal floor area is used to achieve a sustainable solution. This criterion can only be reformulated in accordance with new requirements by residents 		

Figure 3 – Information given to the experimental subjects for use in creating their rehabilitation proposals. Summary of the functional programme for the dwellings and the rules for transformations.

STEP 3

As explained in *Part 2: Chapter 1.4.3*, the goal of Step 3 was to test the proposed grammar on dwellings that had not been used to infer the rules in order to check whether they provided the compositional means for making new transformations in other existing dwellings for other families.

This experiment was carried out by a class of 22 architecture students. The final layouts obtained from this experiment were as follows, by experimental subject group (see Figure 4):

- Group 01 – Did not complete the experiment in 3 hours. They failed to obey four shape rules during the derivation. The rules that were not obeyed were concerned with dimension conditions (net area and length and weights (to position new bathrooms). The derivation was performed immediately, without revising any decisions. The final result contained misinterpretations.
- Group 02 – Completed the experiment in 3 hours. They obeyed all the shape rules and explored a viable and correct dwelling layout in accordance with the transformation grammar. One rule was misinterpreted but the final result was good and the questions raised by the misinterpretation were transferred to a new grammar rule. The derivation was completed at the second attempt. The final result was positive.
- Group 03 – Completed the experiment in 4 hours (initial session of 3h and second session of 1h). The derivation was performed immediately, without revising decisions. The final result was positive.
- Group 04 – Completed the experiment in 3 hours. In some cases, they did not follow the rule application sequence but this was not relevant to completion of the exercise. They failed to obey some shape rules during derivation. The rules that were not obeyed were concerned with dimension conditions (net floor area) and led to an incorrect dwelling layout. The final result contained misinterpretations.
- Group 05 – Did not complete the experiment in 3 hours. They did not obey 1 fundamental shape rule concerning the assignment of the private bathroom and the dwelling layout was therefore incorrect. This group invented new rules and misinterpreted the exercise. The final result was negative.
 - The 5th group tried to accomplish the exercise in a second session of 2 hours using a different dwelling. The dwelling was too small for the family's extra requests. The experimental subjects reached a solution but did not consider the articulation/function conditions of the rules. They also did not explore the rules for changing the shape of rooms. The final result was viable but as the rule conditions were not met, it would have rated badly in terms of functional organisation.
- Group 06 – Completed the experiment in 3 hours. They obeyed all the shape rules and explored a viable and correct dwelling layout according to the transformation grammar. The derivation was completed at the second attempt because of a simple mistake that could have been avoided if they had read the rule application sequence carefully. The final result was positive.
- Group 7 – Completed the experiment in 3 hours. One demolition not included in the rules was performed and the geometry of the final layout was altered without any apparent benefit. Due to lack of compliance with the rule conditions, a rule was applied

wrongly and an unnecessary new space was created. The derivation was completed at the second attempt because of a simple mistake that could have been avoided if they had read the rule application sequence carefully. The final result contained misinterpretations.

- Group 08 – Completed the experiment in 5 hours (initial session of 3h and second session of 2h). In the first session they anticipated the assignment of the guest bathroom without obeying the rule and reached a dead-end. The final result was negative. In the second session they made new mistakes (altering the order of the rules) but achieved a positive result.
- Group 09 – Completed the experiment in 3 hours. The dwelling assigned to this group contained a special feature that led to a misinterpretation of a shape rule – this new aspect was subsequently included in the grammar. This group added an unnecessary new private bathroom by using a rule wrongly and this led to an incorrect result. They failed to obey some shape rules during derivation. The rules that were not obeyed concerned dimension conditions (net area), functional conditions (functions associated with labels) and weights (demolition of structural elements). The derivation was performed immediately without revising decisions. The final result contained misinterpretations.
- Group 10 – Did not complete the experiment in 3 hours. The given dwelling did not fulfil family needs. They failed to obey some shape rules during derivation. The rules that were not obeyed concerned labels (the left shape rule label did not correspond to the one they used). These wrongly applied rules led to incorrect dwelling layouts. The final result contained misinterpretations.

	Dwelling	Experimental subjects		
Family 1	(D1) Pr. Afrânio Peixoto, 13 (type a)	01 2 people	02 2 people	
Family 2	(D1) Pr. Afrânio Peixoto, 13 (type a)	03 1 person	04 2 people	05 (1st session) 3 people
	(D2) R. Actor Isidoro, 16 (type d)			05 (2nd session) 3 persons
Family 3	(D3) Calçada do Galvão, 135 (type d)	06 2 people	07 3 people	
Family 4	(D4) Estrada de Benfica 490 (type d)	08 1 person	09 3 people	
Family 5	(D5) Av. de Roma, 85 (type a)	10 3 people		
			Did not complete the experiment and did not comply with all the rules	Completed the experiment but did not comply with all the rules
			Did not complete the experiment but complied with the rules	Completed the experiment and complied with all the rules

Table 8 – Composition of groups in the 3rd experiment

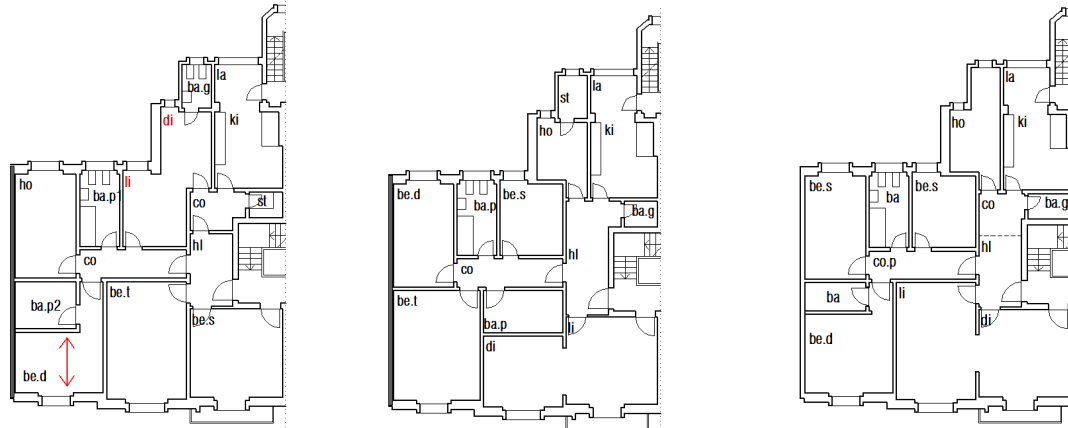

f1_d1_es01

f1_d1_es02

f2_d1_es03

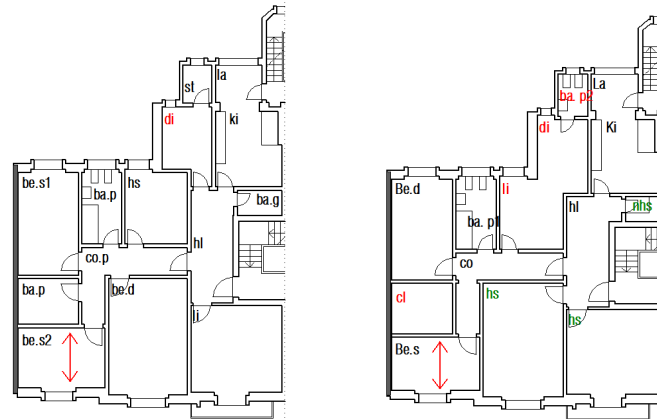

f2_d1_es04

f2_d1_es05(1st)

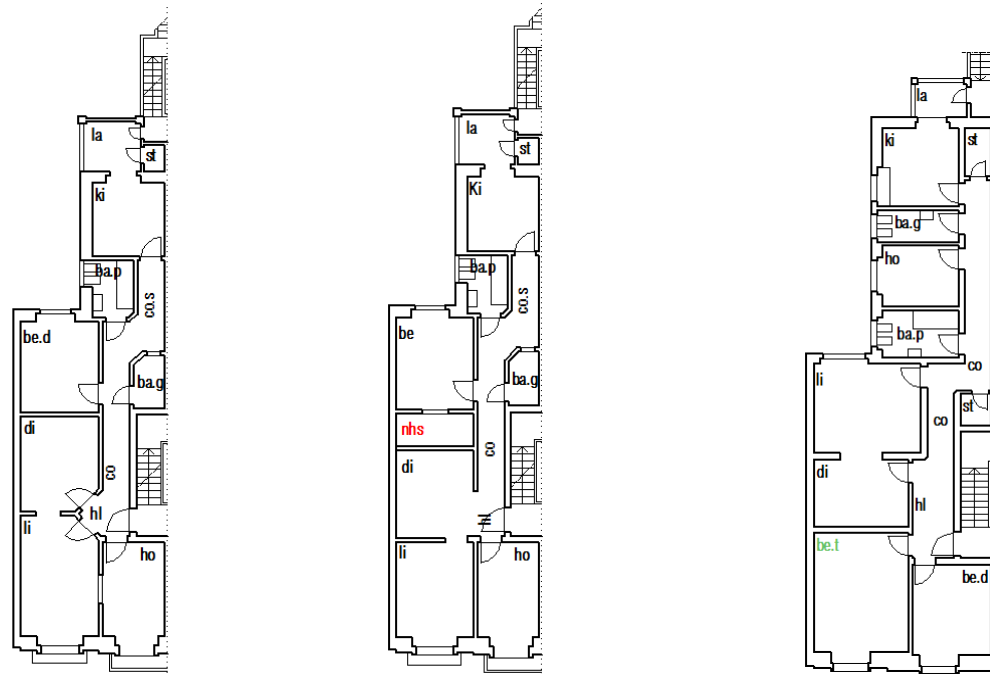

f3_d3_es06

f3_d3_es07

f2_d2_es05(2nd)

Figure 4 (continued on next page) – Final dwelling layouts at the end of the experiment, by experimental subject groups. f (family); d (dwelling), es (experimental subject)

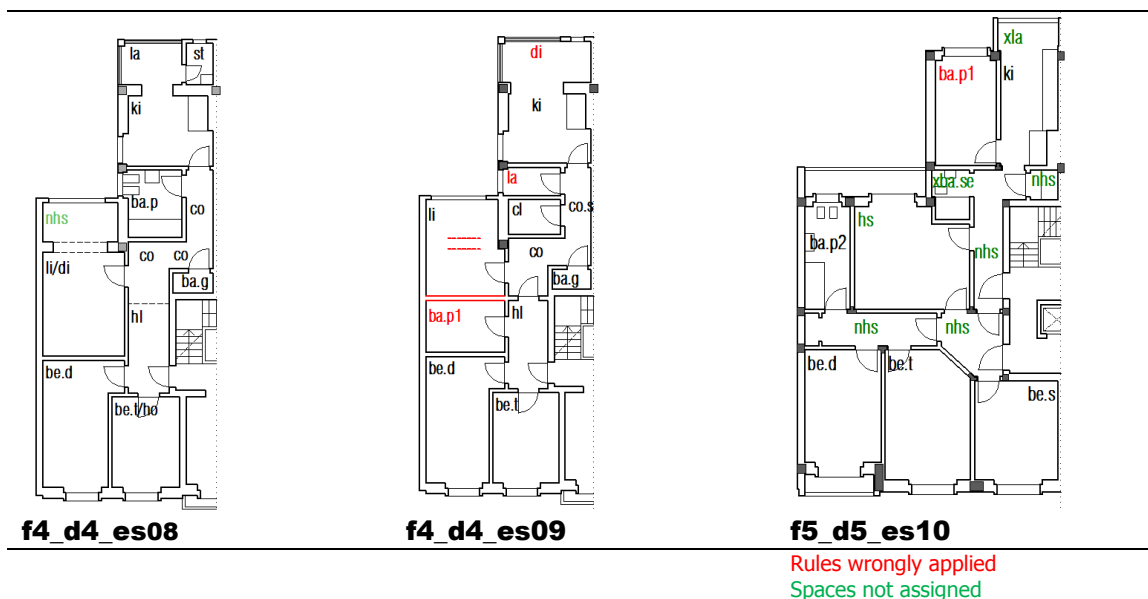

Figure 6 (continuation of the previous page) – Final dwelling layout at the end of the experiment, by experimental subject groups. f (family); d (dwelling), es (experimental subject)

The following conclusions can be drawn from this experience:

- Contrary to what happened in the second step of the experiment, the demolition restrictions were not considered a problem in transforming the dwelling, except in one case involving one group derivation;
- The major difficulty was finding rooms that met the net floor area conditions. Almost all the rooms were smaller than the areas requested. This obstacle led to some possible solutions that need to be integrated into the rules:
 - Assigning a tolerance to the requested area, e.g. 10% ($F \geq 9m^2$ means that $F \geq 8,1m^2$) → this was included in the revised grammar rules;
 - Allowing a room, e.g. a double bedroom, to be allocated to a smaller space if the floor area could be enlarged. This possibility is difficult to introduce as a rule because a large number of shape, dimensional and functional conditions have to be met in relation to all the surrounding rooms;
 - Allowing a space to first be enlarged and then assigned a function;
 - Using the areas required for the minimum level, even if the recommended level had been chosen by the family → this was included in the revised grammar rules;
- Instead of having a sequence of *assignment* then *changing shape* rules for each functional area, the experiment revealed that it would be better to have the *assignment* rules for all the functional areas and then all the *changing shape* rules separately. This would enable room shape to be changed whenever necessary rather than based only on the predefined sequence → this conclusion was included in the revised grammar rules;
- Instead of having different *changing shape* rules for each of the functional areas, it was preferable to have the group of *changing shape* rules with the shape part equal and the conditions differing according to functional or dimensional restrictions → this conclusion was included in the revised grammar rules;

- As there are mandatory rooms (those required by the functional programme) and optional rooms (the extra ones required by the family, in order of priority) and it is sometimes not possible to satisfy all requirements, it would be better assign in the following order:
- Firstly, allocate and ensure the mandatory rooms;
 - Secondly, allocate the optional rooms.

Although this option is an interesting possibility, its application would solve some problems but also create others. The main new problem would be the difficulty in keeping the divisions in the different functional areas together, given that they would be attributed at different stages.

Av. Roma, 89 (type a)

Net floor area: 97m² | Gross floor area: 118m²

Family01_ CASE 1

couple with children (2 adults + 3 children, 5, 2, 0 years)

Original dwelling

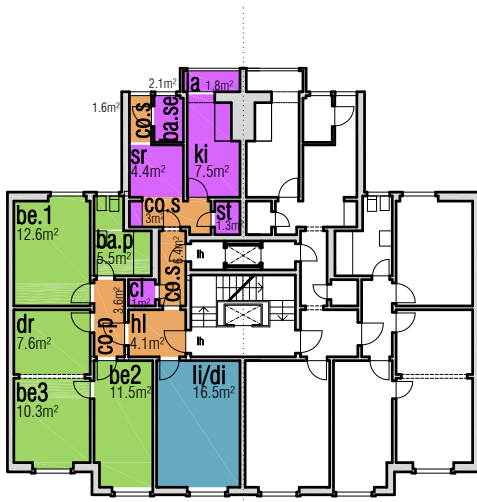

Right : Left

Justified graph

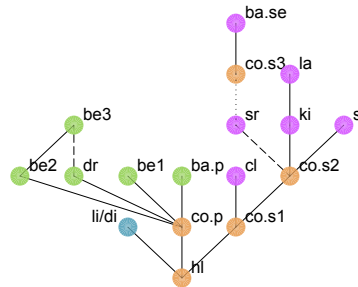

Distributness

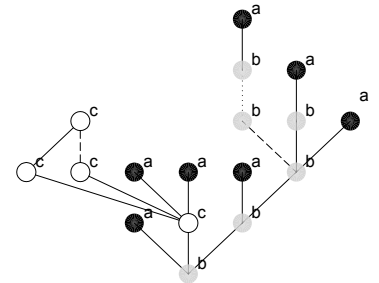

Controle

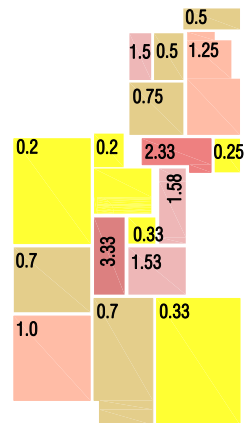

Entire dwelling
Mean: 1.00

Contiguity

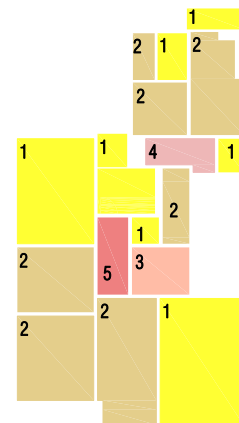

Depth

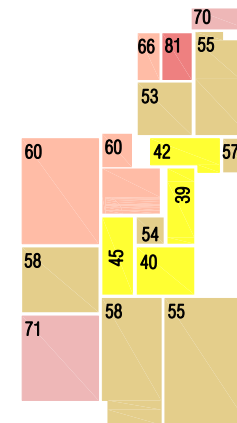

Entire dwelling
Mean: 57

Integration

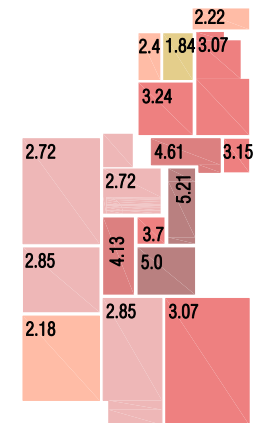

Entire dwelling
Mean: 3.2

Rehabilitation programme

Obligatory rooms

- _ kitchen
- _ double bedroom
- _ children bedrooms
- _ separate or combined living room and dining room
- _ private bathroom (1st)
- _ private bathroom (2nd)

Extra divisions requested by the family (in order of priority) and relationships between divisions

- _ 1 twin bedroom + 1 single bedroom for children next to double bedroom
- _ small work area isolated or integrated with other area
- _ 2 fully equipped private bathrooms in private area
- _ The dining room and living room should be a big room, combined or separate but adjacent, enabling them to be linked for social events
- _ guest bathroom next to social area

- a _ terminal spaces
- b _ reached by two or more arcs
- c _ reached by two or more arcs and connected in a ring
- Social area
- Private area
- Circulation area
- Service area



Transformation proposed ↻

experimental subject #1

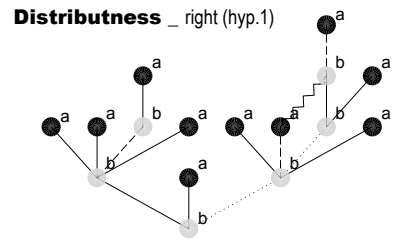
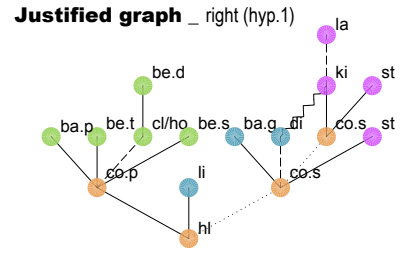
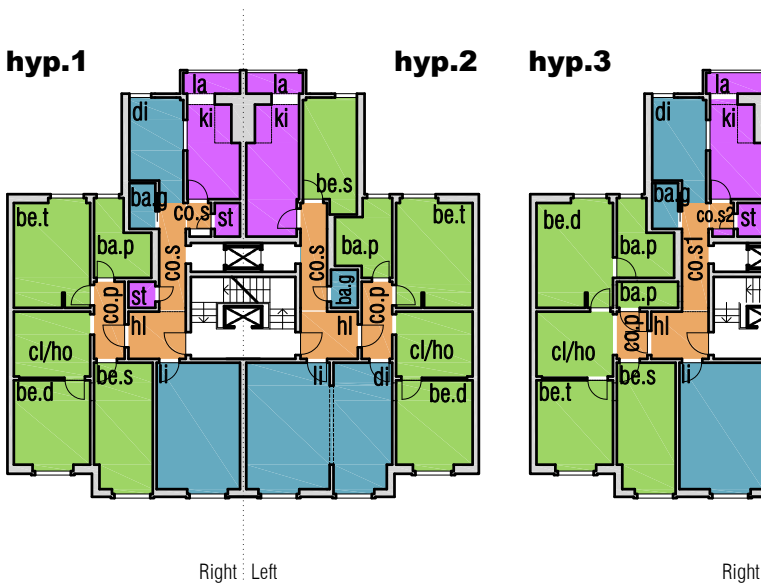

Demolitions / constructions

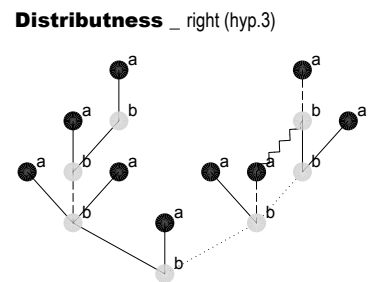
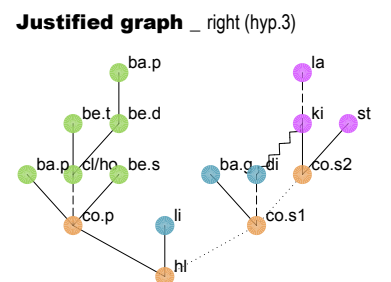
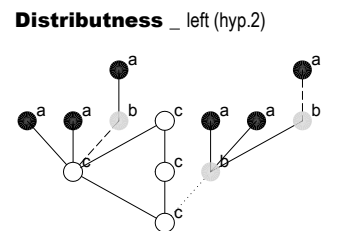
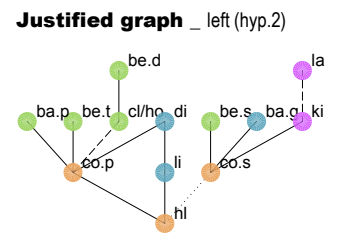
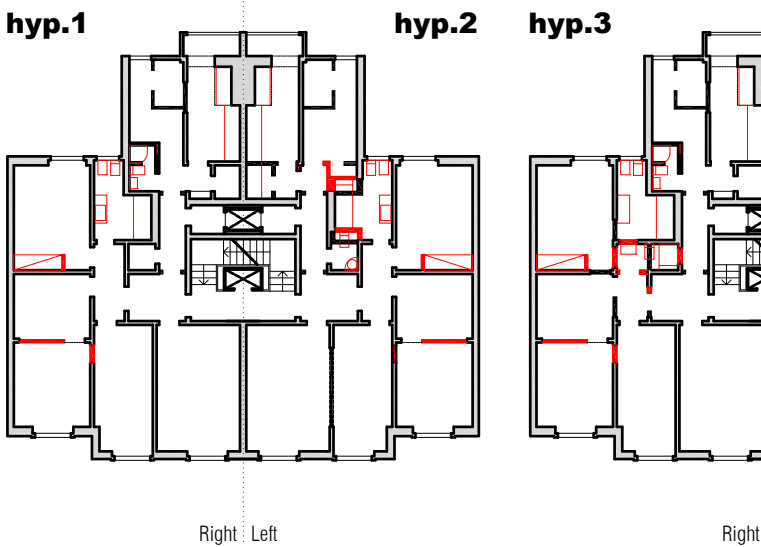

Right (hyp.1) _ few demolitions; few new constructions
 Left (hyp.2) _ many demolitions; few new constructions
 Right (hyp.3) _ many demolitions; few new constructions

- a _ terminal spaces
- b _ reached by two or more arcs
- c _ reached by two or more arcs and connected in a ring
- Social area
- Private area
- Circulation area
- Service area

Adjacency (arcs)
 merged — door (single) = door (double) - - - passage ~ window

Transformation proposed ↻

Demolitions / constructions

experimental subject #2a



Justified graph

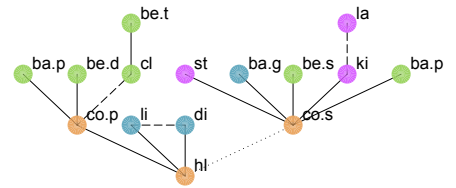

Distributness

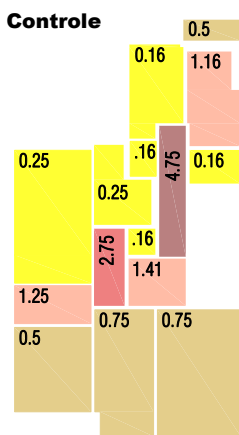
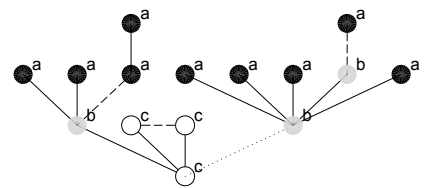

Entire dwelling
Mean: 1.00

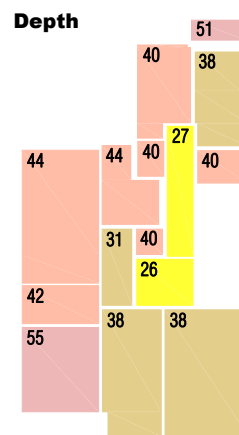
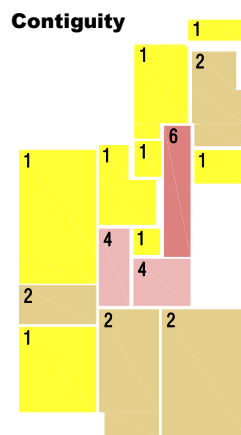

Entire dwelling
Mean: 39.6

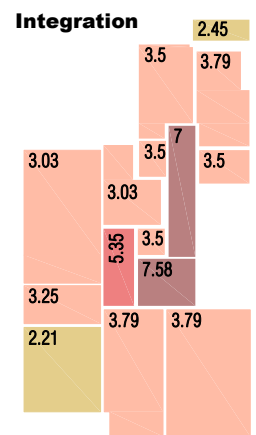

Entire dwelling
Mean: 3.95

General criteria for transforming the dwellings in the study

- Enlargement of existing living room (usually small) using the adjacent bedroom.
- Living room(s) orientated towards the main facade or towards maximum sunlight, rather than north-facing.
- Bedrooms located close to bathrooms, and creation of suite, if possible.
- Enlargement of kitchen area, (usually very compartmentalised), using the space in adjacent areas.
- Conversion of larders/storerooms into guest bathrooms required by the programme, using a macerator system.
- Reduction of circulation areas to the minimum, including within storerooms.

Specific criteria for transforming this dwelling

- Creation of a large social area consisting of a hall adjacent to two adjoining living rooms - one living room created by converting a bedroom.
- Alterations to the existing private area: 3 bedrooms, 1 interior, converted into 2 bedrooms, both with storage facilities.
- Creation of a guest bathroom in the space where the former service area storeroom was located.
- Creation of a bedroom with storage facilities in the space where the former service bedroom and bathroom were located.
- Bedroom next to kitchen was not used to extend the latter, as it was required in the proposed programme.

- a _ terminal spaces
- b _ reached by two or more arcs
- c _ reached by two or more arcs and connected in a ring
- Social area
- Private area
- Circulation area
- Service area



Transformation proposed

Demolitions / constructions

experimental subject #2b

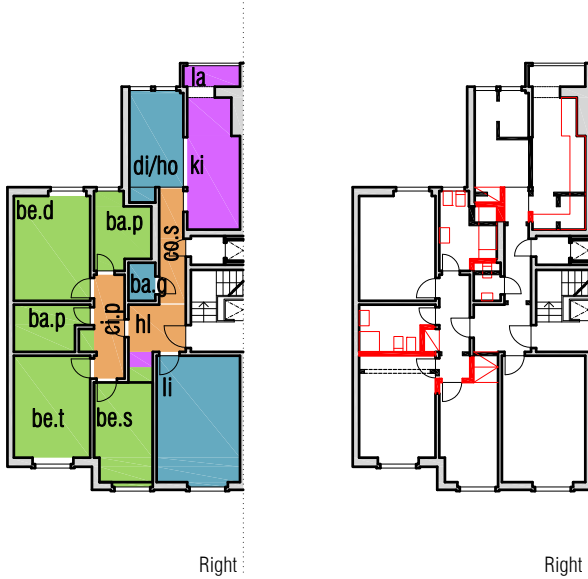

Justified graph

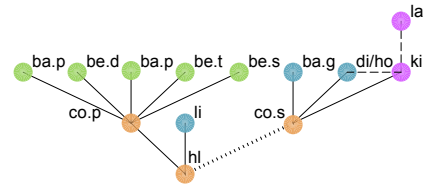

Distributness

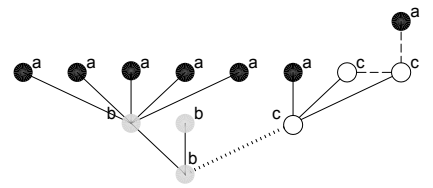

Controle

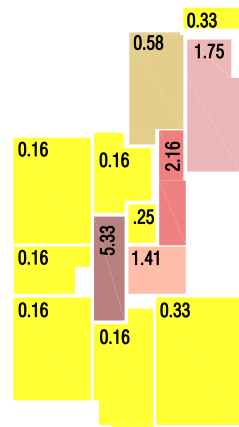

Entire dwelling
Mean: 1.00

Contiguity

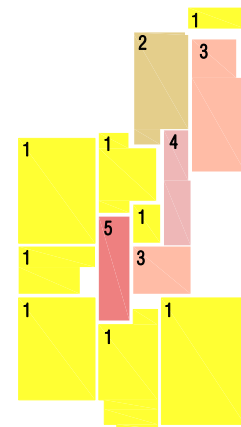

Depth

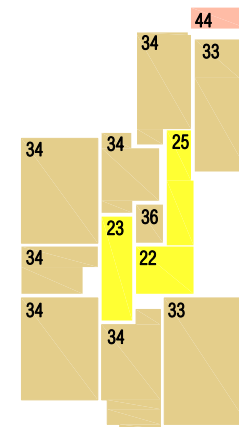

Entire dwelling
Mean: 32.3

Integration

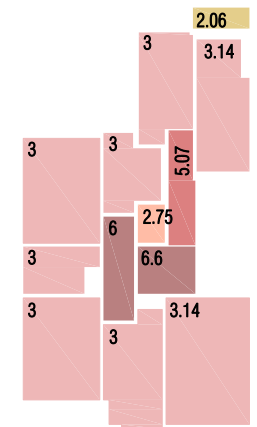

Entire dwelling
Mean: 3.59

- a _ terminal spaces
- b _ reached by two or more arcs
- c _ reached by two or more arcs and connected in a ring
- Social area
- Private area
- Circulation area
- Service area



Transformation proposed

Demolitions / constructions

experimental subject #2c

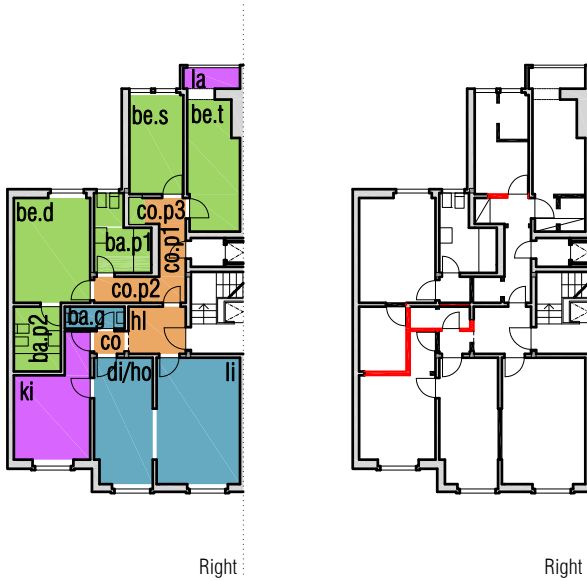

Justified graph

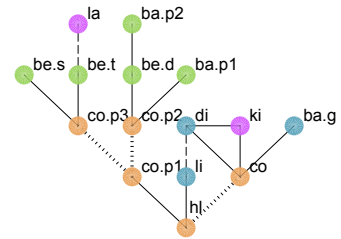

Distributness

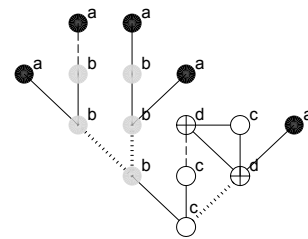

Controle

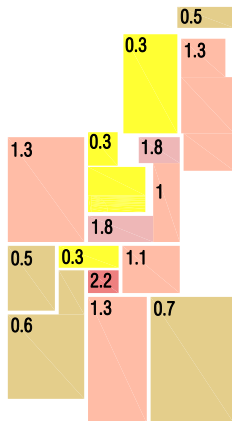

Entire dwelling
Mean: 1.00

Contiguity

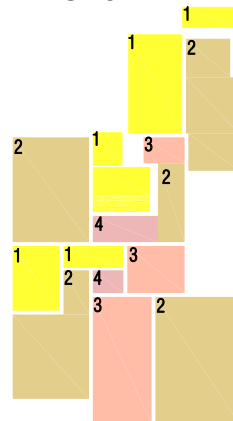

Depth

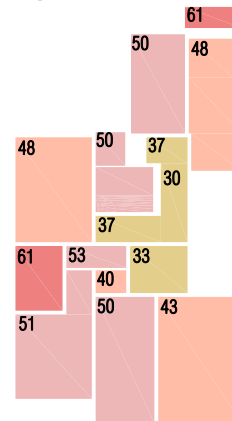

Entire dwelling
Mean: 46.1

Integration

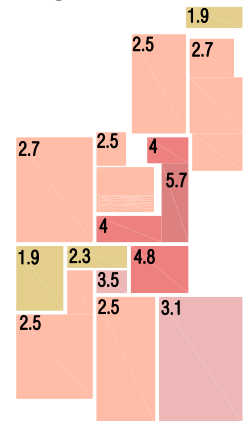

Entire dwelling
Mean: 3.1

- a _ terminal spaces
- b _ reached by two or more arcs
- c _ reached by two or more arcs and connected in a ring
- ⊕ d _ reached by two or more arcs and connected by ≥ 2 rings
- Social area
- Private area
- Circulation area
- Service area



Transformation proposed ⊕ **Demolitions / constructions**

experimental subject #2d



Justified graph

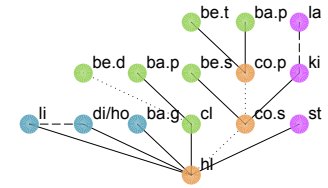

Distributness

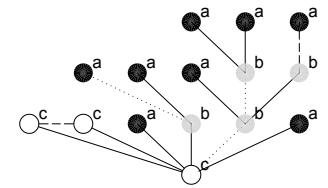

Controle

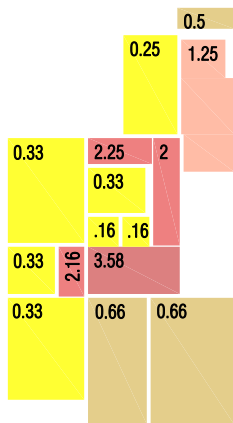

Entire dwelling
Mean: 1.00

Contiguity

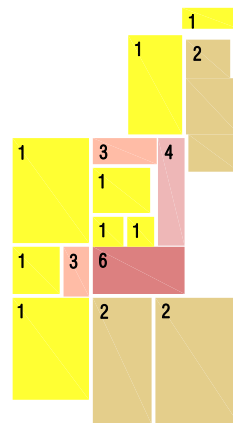

Depth

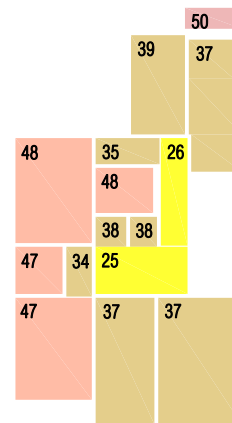

Entire dwelling
Mean: 39.06

Integration

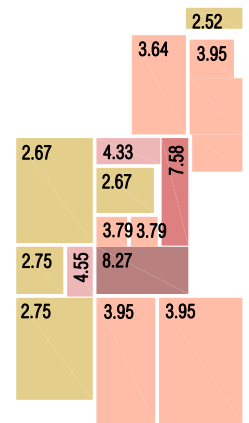

Entire dwelling
Mean: 4.08

- a _ terminal spaces
- b _ reached by two or more arcs
- c _ reached by two or more arcs and connected in a ring
- Social area
- Private area
- Circulation area
- Service area



Transformation proposed Demolitions / constructions

experimental subject #2e



Justified graph

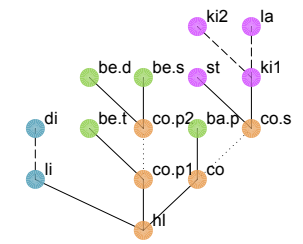

Distributness

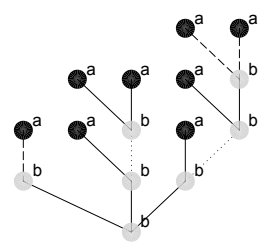

Controle

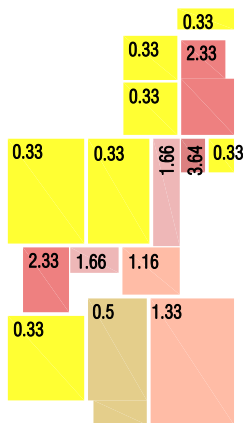

Entire dwelling
Mean: 1.00

Contiguity

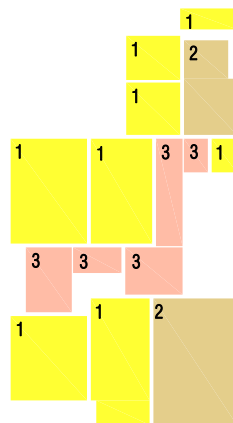

Depth

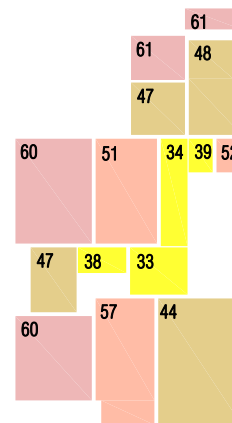

Entire dwelling
Mean: 48.8

Integration

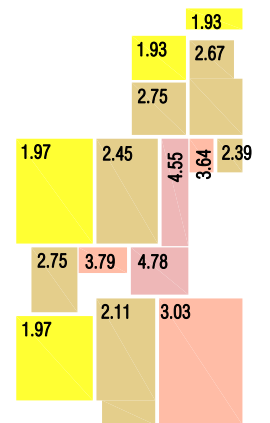

Entire dwelling
Mean: 2.85

- a _ terminal spaces
- b _ reached by two or more arcs
- c _ reached by two or more arcs and connected in a ring
- Social area
- Private area
- Circulation area
- Service area



Rehabilitation evaluation

Obligatory rooms

- _ kitchen
- _ laundry
- _ double bedroom
- _ twin bedroom/single bedroom
- _ separate or combined living room and dining room
- _ private bathroom (1st)
- _ private bathroom (2nd)
- _ storeroom

Extra divisions requested by the family (in order of priority) and relationships between divisions

- _ 2 bedroom for children
- _ small work area
- _ 2 fully equipped private bathrooms
- _ one large or two separate living rooms
- _ bathroom for general use
- _ all bedrooms next to each other

Evaluation of the experiments:

YES answers / total questions

Experimental subject #1

hyp 1 _ 33/36

hyp 2 _ 30/36

hyp 3 _ 34/36

Experimental subject #2a

hyp 1 _ 32/36

Experimental subject #2b

hyp 1 _ 34/36

Experimental subject #2d

hyp 1 _ 30/36

Experimental subject #2e

hyp 1 _ 28/36

General characteristics

- _ Bedrooms and living rooms have natural light and ventilation
- _ The daytime area (living rooms + kitchens) can be separated from the night-time area (bedrooms and private bathrooms) by doors or a corridor

Social area

- _ The social area is accessed via the circulation areas
- _ The dining room and living room are combined or separate but adjacent, enabling them to be linked
- _ The dining room is close to the kitchen
- _ There is a bathroom for general use with easy access that does not involve passing through private or social areas
- _ The bathroom for general use has no door opening onto any room
- _ Social spaces are close to the entrance for easy access
- _ The living room is large enough to allow for the possibility of installing furniture for viewing TV or home cinema from a distance of 3m
- _ There is individual access to the living room(s) via a circulation area or other living room
- _ All living rooms comply with minimum area requirements

Private area

- _ Bedrooms and private bathrooms are accessed from circulation areas other than those of the hall and the social and service zone circulation areas
- _ The bedrooms have access to a bathroom within the same private area
- _ All bedrooms comply with minimum area requirements

Service area

- _ The kitchen is accessed by circulation areas or via a living room, if it is not the only one
- _ The kitchen includes an eating area for light meals or is close to an eating area
- _ The kitchen includes a space for laundry work or has a direct link to a space reserved for this purpose
- _ The kitchen complies with minimum area requirements

Circulation areas

- _ The circulation areas allow for alternative paths within the dwelling
- _ There are no obstacles to circulation within the social area
- _ There are no obstacles to circulation within the service area
- _ There are no obstacles to circulation within the private area

Demolition work

- _ Linear dimensions of walls demolished _____

APPENDIX 3

Transformation grammar rules

Generating a compound representation

Rule -1.1a _ Generation of a compound representation – using surfaces to represent rooms

Rule -1.1a1

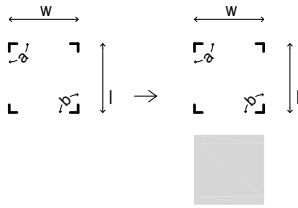

Rule -1.1a5

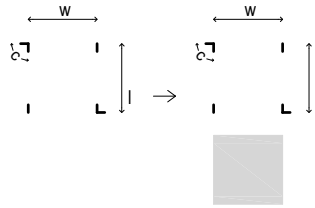

Rule -1.1a2

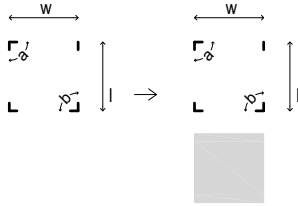

Rule -1.1a6

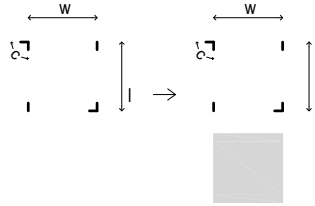

Rule -1.1a3

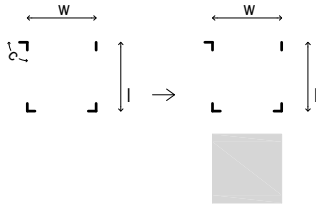

Rule -1.1a7

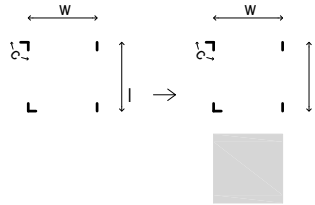

Rule -1.1a4

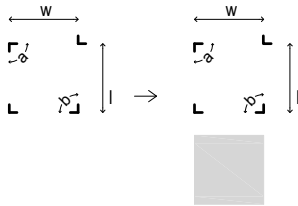

Rule -1.1a8

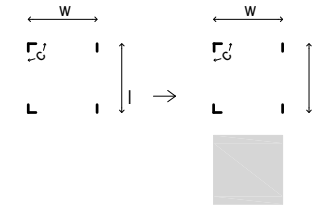

Rule -1.1a9

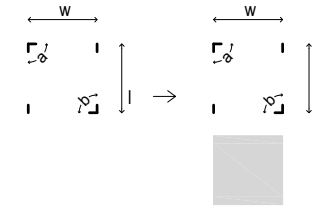

Rule -1.1a10

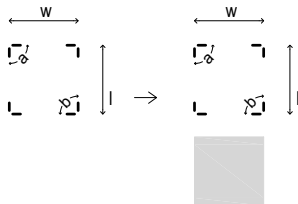

Rule -1.1a12

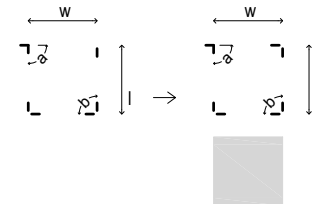

Rule -1.1a11

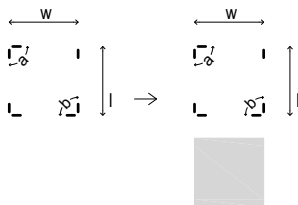

Conditions:

- Dimensions:
- $l, w \geq 0.65\text{m}$
- $l * w \geq 0.8\text{m}^2$
- $80^\circ \leq a \leq 90^\circ$
- $90^\circ \leq b \leq 98^\circ$
- $90^\circ \leq c \leq 180^\circ$

Generating a compound representation

Rule -1.1b_ Generation of a compound representation – using surfaces to represent rooms

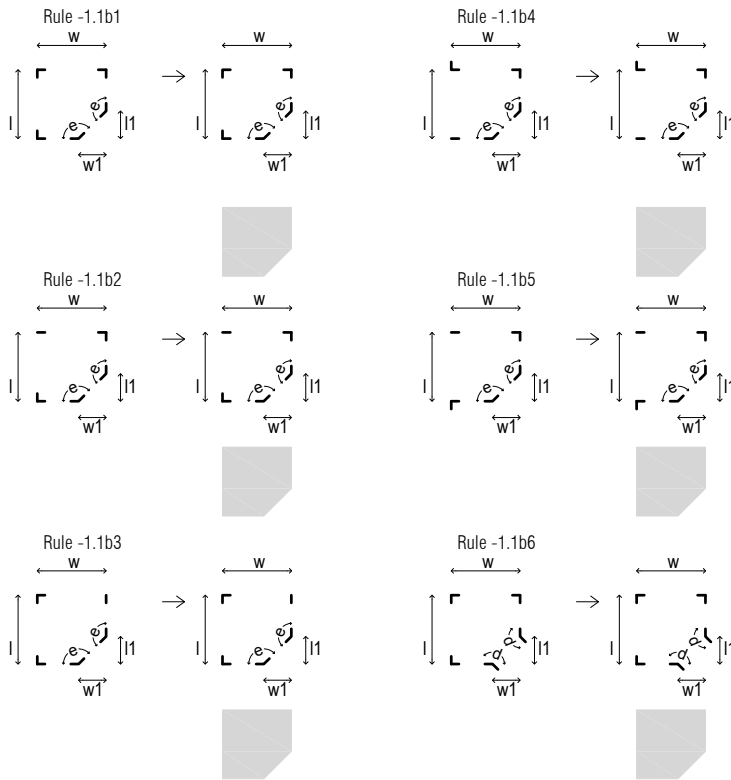

Conditions:

Dimensions:

$l, w \geq 1m$

$l_1, w_1 \geq 0.2m$

$45^\circ \leq d \leq 135^\circ$

$e = 135^\circ$

Rule -1.1c_ Generation of a compound representation – using surfaces to represent rooms

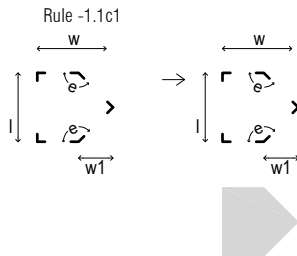

Conditions:

Dimensions:

$l, w \geq 1m$

$w_1 \geq 0.8m$

$l * w \geq 1m^2$

$e = 135^\circ$

Generating a compound representation

Rule -1.1d _ Generation of a compound representation – using surfaces to represent rooms

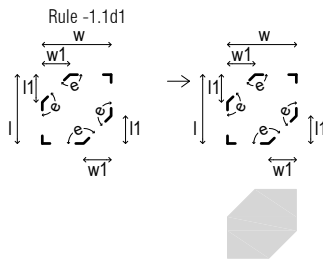

Conditions:
 Dimensions:
 $l, w \geq 1m$
 $l1, w1 \geq 0.2m$
 $e = 135^\circ$

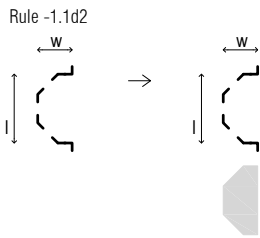

Conditions:
 Dimensions:
 $l \geq 2m$
 $w \geq 1m$

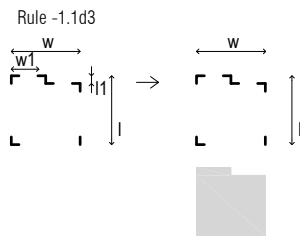

Conditions:
 Dimensions:
 $l, w \geq 1m$
 $l * w \geq 1m^2$
 $l1, w1 \geq 0.2m$

Rule -1.1e _ Generation of a parallel representation – using surfaces (interior passages and windows)

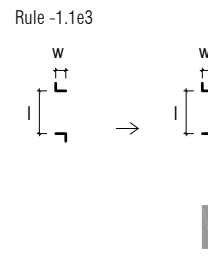
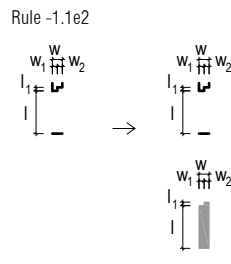
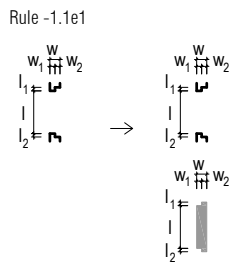

Conditions:
 Dimensions:
 $l \geq 0,8m$
 $0,10m \leq w, w1 \leq 0,55m$
 $0m \leq w2 \leq 0,45m$
 $0m \leq l1, l2 \leq 0,25m$

Rule -1.2 _ Generation of a compound representation – using dots and arcs to represent rooms and connections

Rule -1.2a _ attribution of a dot to represent one room

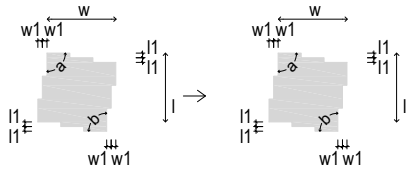

Conditions:

- Dimensions:
- $l, w \geq 0.65m$
- $0.8m^2 \leq l * w \leq 30m^2$
- $0m \leq l1, w1 \leq 1m$
- $80^\circ \leq a \leq 90^\circ$
- $90^\circ \leq b \leq 98^\circ$

Rule -1.2b _ attribution of a dot to represent one room

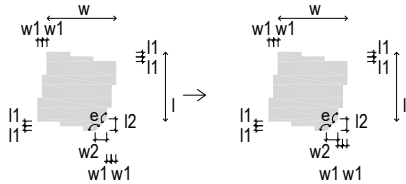

Conditions:

- Dimensions:
- $l, w \geq 1m$
- $1m^2 \leq l * w \leq 30m^2$
- $l2, w2 \geq 0.2m$
- $e = 135^\circ$

Rule -1.2c _ attribution of a dot to represent one room

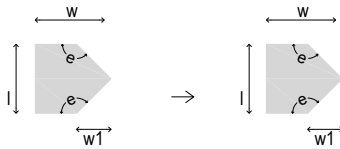

Conditions:

- Dimensions:
- $l, w \geq 1m$
- $w1 \geq 0.8m$
- $0.8m^2 \leq l * w \leq 30m^2$
- $e = 135^\circ$

Rule -1.2d _ attribution of a dot to represent one room

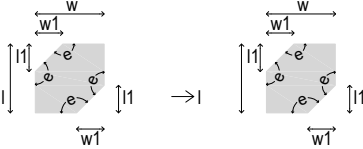

Conditions:

- Dimensions:
- $l, w \geq 1m$
- $0.8m^2 \leq l * w \leq 30m^2$
- $l1, w1 \geq 0.2m$
- $e = 135^\circ$

Rule -1.2e _ attribution of a dot to represent one room

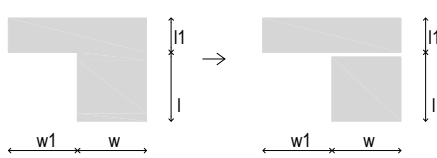

Conditions: (this situation happens only once)

- Dimensions:
- $2m \leq l, w \leq 6m$
- $l1 \leq l$
- $w1 \geq w$

Rule -1.2f _ attribution of a dot to represent one rooms

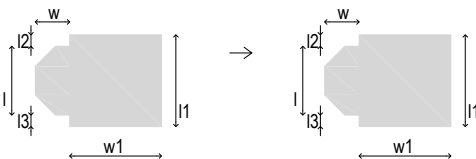

Conditions:

- Dimensions:
- $l \geq 2m$
- $w \geq 1m$
- $l1 \geq 3m$
- $w1 \geq 3m$
- $9m^2 \leq l1 * w1 \leq 30m^2$
- $l2, l3 \geq 0.1m$
- $l2 = l3 \vee l2 \neq l3$

Rule -1.2g _attribution of a dot with a label to the exterior

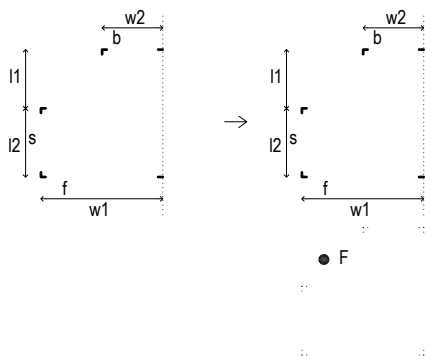

Conditions:
 Dimensions:
 $4m \leq l1 \leq 14.5m$
 $9.4m \leq l2 \leq 14m$
 $5.7m \leq w1 \leq 18.5m$
 $3m \leq w2 \leq 7.2m$
 Function:
 $F = ext$

Rule -1.2h _attribution of an arc between two connecting rooms (with a door between them)

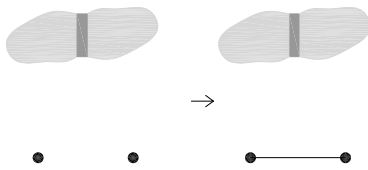

Description (abbreviated):
 $R-1.2h < D-1: \emptyset > \rightarrow < D-1: passage_to >$

Rule -1.2i _attribution of an arc between two adjacent rooms (with a wall and no door between them)

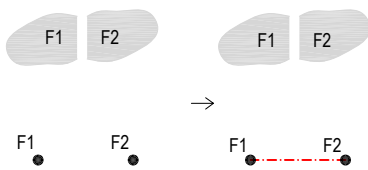

Conditions: Description (abbreviated):
 $F1 (passage_to(F2)) = FALSE$ $R-1.2i < D-1: \emptyset > \rightarrow < D-1: adjacent_to >$

Rule -1.2j _attribution of an arc between the exterior and a room with a window

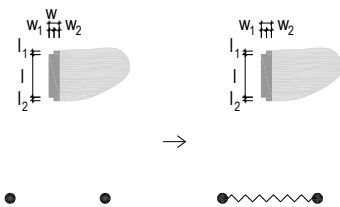

Conditions: Description (abbreviated):
 Dimensions:
 $l \geq 0,8m$
 $0,10m \leq w, w1 \leq 0,55m$
 $0m \leq w2 \leq 0,45m$
 $0m \leq l1, l2 \leq 0,25m$
 $R-1.2j < D-1: \emptyset > \rightarrow < D-1: window_to >$

Notes:

Part2: Chapter 4.3

Generating a compound representation

Rule -1.3 _ Attribution of labels for the dwelling rooms

Rule -1.3a _ Attribution of Xba label

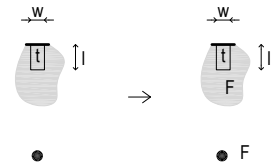

Conditions:
 Dimensions:
 $0.45m \leq l \leq 0.65m$
 $1m^2 \leq F \leq 7m^2$
 Function:
 $Fb = ext$
 $F = Xba$

Description (abbreviated):
 $R-1.3a < D-1: \emptyset > \rightarrow < D-1: Xba >$

Rule -1.3b _ Attribution of Xki label

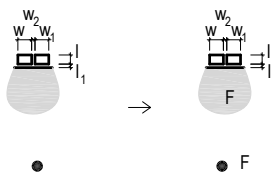

Conditions:
 Dimensions:
 $0.1m \leq l \leq 0.3m$
 $0.2m \leq w \leq 0.5m$
 $0m \leq w1 \leq 0.5m$
 $0.1m \leq w2, l1 \leq 0.2m$
 $F \geq 6m^2$
 Function:
 $F = Xki$

Description (abbreviated):
 $R-1.3b < D-1: \emptyset > \rightarrow < D-1: Xki >$

Rule -1.3c _ Attribution of Xla label

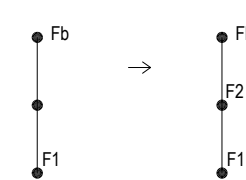

Conditions:
 Dimensions:
 $1.5m^2 \leq F2 \leq 9m^2$
 Function:
 $F1 = Xki$
 $Fb = ext$
 $F2 = Xla$

Description (abbreviated):
 $R-1.3c < D-1: Fb, \emptyset, F1 > \rightarrow < D-1: Fb, F2, F1 >$

Rule -1.3d _ Attribution of hs label



Conditions:
 Dimensions:
 $F \geq 7m^2 (\pm 10\%)$
 Function:
 $Fb = ext$
 $F = hs$

Description (abbreviated):
 $R-1.3d < D-1: Fb, \emptyset > \rightarrow < D-1: Fb, F >$

Rule -1.3e _ Attribution of nhs label

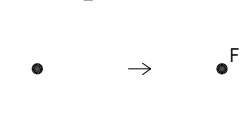

Conditions:
 Dimensions:
 $F < 7m^2$
 Function:
 $F = nhs$

Description (abbreviated):
 $R-1.3e < D-1: \emptyset > \rightarrow < D-1: nhs >$

Notes:

Xba label stands for *Existing bathroom*; Xki label stands for *Existing kitchen*; Xla label stands for *Existing laundry*; hs label stands for *Habitable Space*; nhs label stands for *Non-Habitable Space*

See Part2: Chapter 4.2.2

Rule -1.4 _ Attribution of weights for the dwelling walls

Rule -1.4a _ Attribution of brick wall (ub) weight

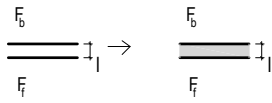

Conditions:
 Dimensions:
 $l \leq 0.25m$
 Functions:
 $F_b, F_f \in \{hs, nhs, Xki, Xba, Xla\}$

Rule -1.4b _ Attribution of structural elements (us) weight

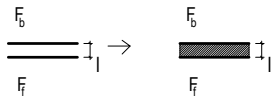

Conditions:
 Dimensions:
 $0.25m \leq l \leq 0.55m$
 Functions:
 $F_b \in \{ext\}$

Rule -1.4c _ Attribution of structural elements (us) weight

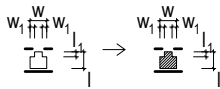

Conditions:
 Dimensions:
 $0.1m \leq l, w \leq 0.5m$
 $0m \leq l, w \leq 0.2m$
 $l=w \vee l \neq w$

Rule -1.4d _ Attribution of side walls (usi) weight

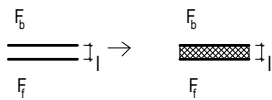

Conditions:
 Dimensions:
 $l > 0.25m$
 Functions:
 $F_b \in \{s\}$
 $F_f \in \{nhs, hs, Xba\}$

Rule -1.5 _ Changing from step -1 to step 0

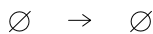

Conditions:
 $\forall wall: wall \in \{wus, wusi, wub\}$
 $\forall connection: connection \in \{arc_connection, surface\}$
 $\forall adjacency: adjacency \in \{arc_adjacency\}$
 $\forall room: room \in \{surface, dot, label\}$

Description (abbreviated):
 $R-1.5 < D-1: S-1 > \rightarrow < D0: S0 >$

Rule 0.1 _ Assignment of isolated kitchen for strategy 2

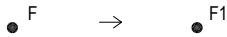

Conditions:

$$Z \supset \{ki\} \wedge Z \not\supset \{ki\}$$

Functions:

$$\text{If}\{\text{strategy2}\} \wedge F \in \{Xki\} \Rightarrow F1 \in \{ki\}$$

Description (abbreviated):

$$R0.1 < D0: F; Z; E > \rightarrow$$

$$< D0: ki; Z + \{ki\}; E - \{Xki\}, E + \{ki\} >$$

Rule 0.2 _ Assignment of area to place new kitchen for strategy 1 and 3

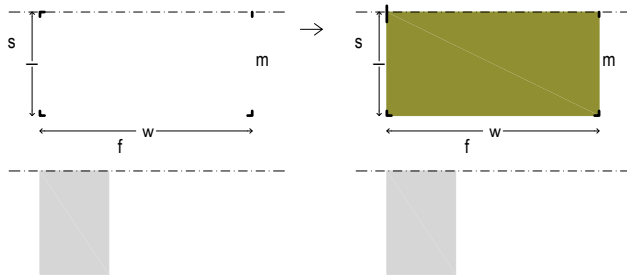

Conditions:

$$Z \supset \{ki\} \wedge Z \not\supset \{ki\}$$

Dimensions:

$$5.7m \leq w \leq 18.5m$$

Description (abbreviated):

$$R0.2 < D0: f, m, s; \emptyset > \rightarrow < D0: f, m, s; uk >$$

Rule 0.3.a _ Assignment of isolated kitchen for strategy 1 (minimum level)

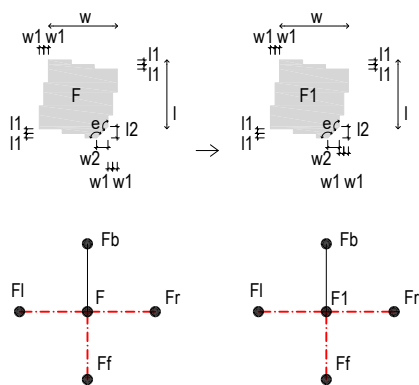

Conditions:

$$Z \supset \{ki\} \wedge Z \not\supset \{ki\}$$

Dimensions:

$$6m^2 \leq F \leq 20m^2 (\pm 10\%)$$

$$l, w \geq 1.7m$$

$$0m \leq l1, w1 \leq 1m$$

$$l2, w2 \geq 0m$$

$$e \in \{135^\circ, 180^\circ\}$$

Functions:

$$Fb \in \{ext\} \wedge Ff \vee Fr \vee Fl \in \{nhs, hs\} \wedge \exists Ff \vee Fr \vee Fl \in \{nhs\} \wedge F \in \{hs\}$$

$$F(\text{inside}(x)) = \text{TRUE}, x \in \{uk\}$$

$$F \in \{Fa\} \vee F \in \{Fb\} \vee F \in \{Fc\}$$

$$\text{If } Fa = \min(A) \wedge A \in \{Fa, Fb, Fc\} \Rightarrow F1 = Fa$$

$$F1 \in \{ki\}$$

Description (abbreviated):

$$R0.3a < D0: \{ext\}, \{nhs\}, Fr, Fl; F; Z; E > \rightarrow$$

$$< D0: \{ext\}, \{nhs\}, Fr, Fl; ki; Z + \{ki\}; E - \{hs\}, E + \{ki\} >$$

Rule 0.3.b _ Assignment of isolated kitchen for strategy 1 (recommended level)

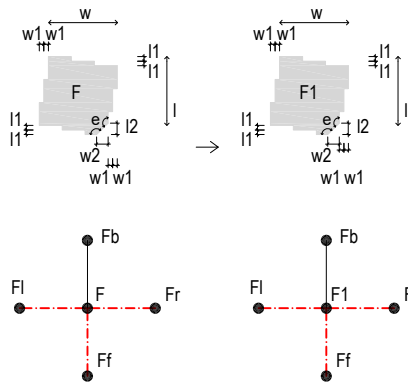

Conditions:

$$Z \supset \{ki\} \wedge Z \not\supset \{ki\}$$

Dimensions:

$$\text{If } nhab=4 \Rightarrow 10.5m^2 \leq F \leq 30m^2 (\pm 10\%)$$

$$\text{If } nhab \geq 5 \Rightarrow 11.5m^2 + 0.5m^2(n-5) \leq F \leq 30m^2 (\pm 10\%)$$

$$l, w \geq 1.7m$$

$$0m \leq l1, w1 \leq 1m$$

$$l2, w2 \geq 0m$$

$$e \in \{135^\circ, 180^\circ\}$$

Functions:

$$Fb \in \{ext\} \wedge F \vee Fr \vee Ff \in \{nhs, hs\} \wedge \exists F \vee Fr \vee Ff \in \{nhs\} \wedge F \in \{hs\}$$

$$F(\text{inside}(x)) = \text{TRUE}, x \in \{uk\}$$

$$F \in \{Fa\} \vee F \in \{Fb\} \vee F \in \{Fc\}$$

$$\text{If } Fa = \min(A) \wedge A \in \{Fa, Fb, Fc\} \Rightarrow F1 = Fa$$

$$F1 \in \{ki\}$$

Description (abbreviated):

$$R0.3b < DO: \{ext\}, \{nhs\}, Fr, Ff; F; Z; E > \rightarrow$$

Rule 0.4 _ Erasing new kitchen's placement weight

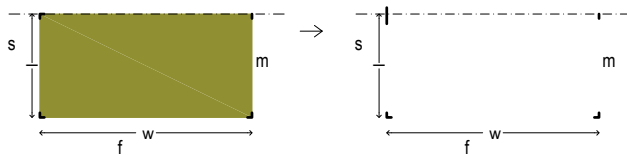

Conditions:

$$Z \supset \{ki\}$$

Dimensions:

$$5.7m \leq w \leq 18.5m$$

$$3m \leq s \leq 5.7m$$

Description (abbreviated):

$$R0.4 < DO: uk > \rightarrow < DO: \emptyset >$$

Rule 0.5 _ Changing Xki label

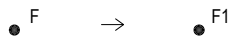

Conditions:

$$Z \supset \{ki\}$$

Functions:

$$F \in \{Xki\}$$

$$F1 \in \{hs\}$$

Description (abbreviated):

$$R0.5 < DO: Xki; E > \rightarrow < DO: hs; E - \{Xki\}, E + \{hs\} >$$

Rule 0.6 _ Changing from step 0 to step 1

$\emptyset \rightarrow \emptyset$

S0 \rightarrow S1

Conditions:

$Z \supset \{ki\} \wedge E \notin \{Xki\}$

Description (abbreviated):

R0.6 < D0 > \rightarrow < D1 >

Hall assignment

Rule 1.1 _ Assignment of hall

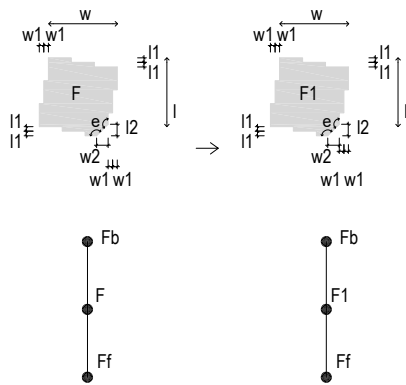

Conditions:

Dimensions:
 $l, w \geq 0,9m$
 $1m^2 \leq F \leq 20m^2$
 $0m \leq l1, w1 \leq 1m$
 $l2, w2 \geq 0m$
 $e \in \{135^\circ, 180^\circ\}$

Functions:

$F \in \{nhs\}$
 $Fb \in \{lh\} \wedge F(\text{passage_to}(lh)) = \text{TRUE}$
 $Ff \in \{nhs\} \wedge F(\text{passage_to}(nhs)) = \text{TRUE}$
 $\Rightarrow F1 \in \{hl\}$

Description (abbreviated):

R1.1 < D1: lh, nhs; F; Z; E > \rightarrow
 < D1: lh, nhs; hl; Z + {hl}; E - {nhs}, E + {hl} >

Rule 1.2 _ Changing from step 1 to step 2

$\emptyset \rightarrow \emptyset$

S1 \rightarrow S2

Conditions:

$Z \supset \{hl\} \wedge E \supset \{hl\}$

Description (abbreviated):

R1.2 < D1: S1 > \rightarrow < D2: S2 >

Bedrooms assignment

Rule 2.1.a _ Assignment of double bedroom (minimum level)

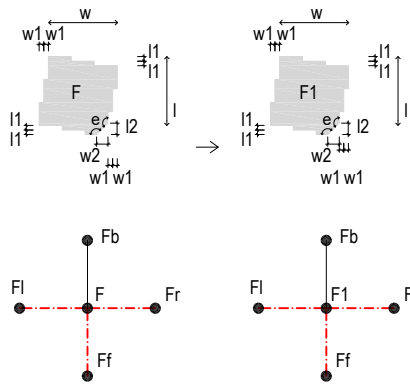

Conditions:
 $Z \supset \{be.dn\} \wedge Z \not\supset \{be.dn\}$

Dimensions:
 $10,5m^2 (\pm 10\%) \leq F \leq 30m^2$
 $w, l \geq 2,7m$
 $0m \leq l1, w1 \leq 1m$
 $l2, w2 \geq 0m$
 $e \in \{135^\circ, 180^\circ\}$

Functions:
 $Fb \in \{ext\}$
 $\exists Ff \vee Fr \vee Fl \in \{nhs, co, co.p, cl\}$
 $Ff \vee Fr \vee Fl \notin \{hl\}$
 $F \in \{hs\}$
 $F1 \in \{be.d\}$

Description (abbreviated):

$R2.1a < D2: ext, \{nhs, co, co.p, cl\}, Ff, Fl, F; Z; E > \rightarrow$
 $< D2: ext, \{nhs, co, co.p, cl\}, Ff, F1; be.d; Z + \{be.d\}; E - \{hs\}, E + \{be.d\} >$

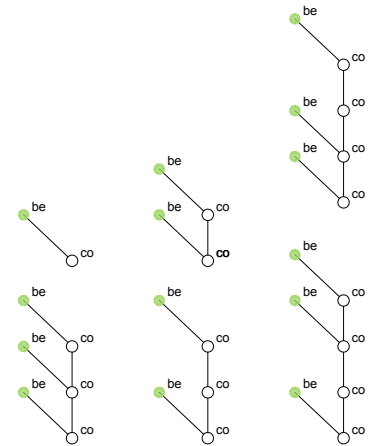

$be \geq 1 * \{be.d, be.t, be.s\}$

Rule 2.1.b _ Assignment of double bedroom (recommended level)

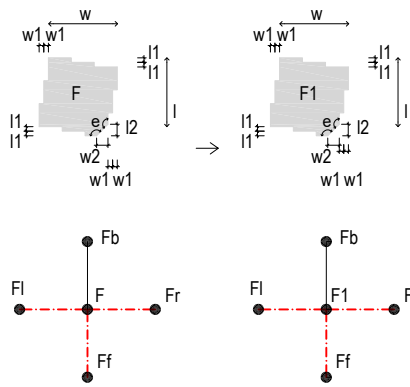

Conditions:
 $Z \supset \{be.dn\} \wedge Z \not\supset \{be.dn\}$

Dimensions:
 $12m^2 (\pm 10\%) \leq F \leq 30m^2$
 $w, l \geq 3,3m$
 $0m \leq l1, w1 \leq 1m$
 $l2, w2 \geq 0m$
 $e \in \{135^\circ, 180^\circ\}$

Functions:
 $Fb \in \{ext\}$
 $\exists Ff \vee Fr \vee Fl \in \{nhs, co, co.p, cl\}$
 $Ff \vee Fr \vee Fl \notin \{hl\}$
 $F \in \{hs\}$
 $F1 \in \{be.d\}$

Description (abbreviated):

$R2.1b < D2: ext, \{nhs, co, co.p, cl\}, Ff, Fl, F; Z; E > \rightarrow$
 $< D2: ext, \{nhs, co, co.p, cl\}, Ff, F1; be.d; Z + \{be.d\}; E - \{hs\}, E + \{be.d\} >$

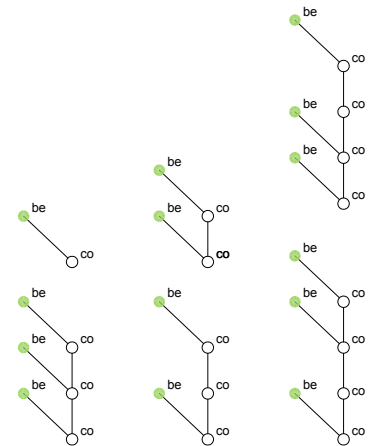

$be \geq 1 * \{be.d, be.t, be.s\}$

Rule 2.2.a _ Assignment of twin bedrooms (minimum level)

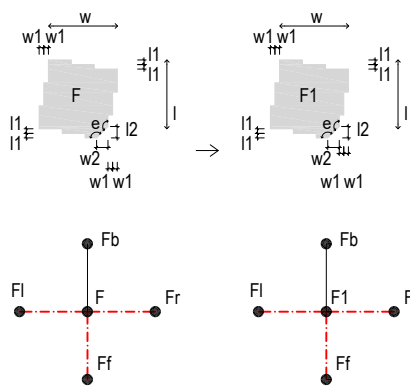

Conditions:
 $Z \supset \{be.tn\} \wedge Z \not\supset \{be.tn\}$

Dimensions:
 $10,5m^2 (\pm 10\%) \leq F \leq 30m^2$
 $w, l \geq 2,1m$
 $0m \leq l1, w1 \leq 1m$
 $l2, w2 \geq 0m$
 $e \in \{135^\circ, 180^\circ\}$

Functions:
 $be.t (next_to(x)) = TRUE \vee be.t (close_to(x)) = TRUE, x \in \{be.d\}$
 $\exists Fb \vee Ff \vee Fr \vee Fl \in \{ext, Cbc\}$
 $\exists Fb \vee Ff \vee Fr \vee Fl \in \{nhs, co, co.p, cl\}$
 $Fb \vee Ff \vee Fr \vee Fl \notin \{hl\}$
 $F \in \{hs\}$
 $F1 \in \{be.t\}$

Description (abbreviated):

$R2.2a < D2: ext, \{nhs, co, co.p, cl\}, Ff, Fl, F; Z; E > \rightarrow$
 $< D2: ext, \{nhs, co, co.p, cl\}, Ff, Fl; be.t; Z + \{be.t\}; E - \{hs\}, E + \{be.t\} >$

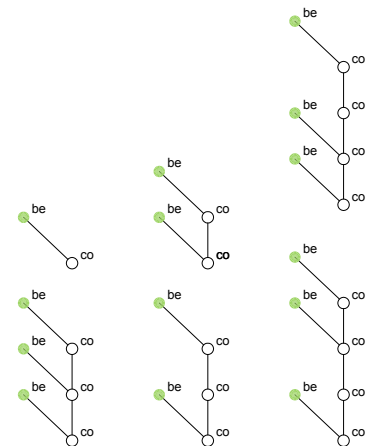

$be \geq 1 * \{be.d, be.t, be.s\}$

Bedrooms assignment

Rule 2.2.b _ Assignment of twin bedrooms (recommended level)

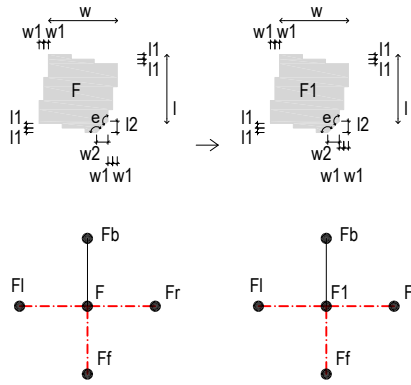

Conditions:

$$Z \supset \{be.tn\} \wedge Z \not\supset \{be.tn\}$$

Dimensions:
 $14.5m^2 (\pm 10\%) \leq F \leq 30m^2$
 $w, l \geq 2,7m$
 $0m \leq l1, w1 \leq 1m$
 $l2, w2 \geq 0m$
 $e \in \{135^\circ, 180^\circ\}$

Functions:

$be.t (next_to(x)) = TRUE \vee be.t (close_to(x)) = TRUE, x \in \{be.d\}$
 $\exists Fb \vee Ff \vee Fr \vee Fl \in \{ext, Cbc\}$
 $\exists Fb \vee Ff \vee Fr \vee Fl \in \{nhs, co, co.p, cl\}$
 $Fb \vee Ff \vee Fr \vee Fl \notin \{hl\}$
 $F \in \{hs\}$
 $F1 \in \{be.t\}$

Description (abbreviated):

$$R2.2b < D2: ext, \{nhs, co, co.p, cl\}, Ff, Fl, F; Z; E > \rightarrow < D2: ext, \{nhs, co, co.p, cl\}, Ff, Fl, be.t; Z + \{be.t\}; E - \{hs\}, E + \{be.t\} >$$

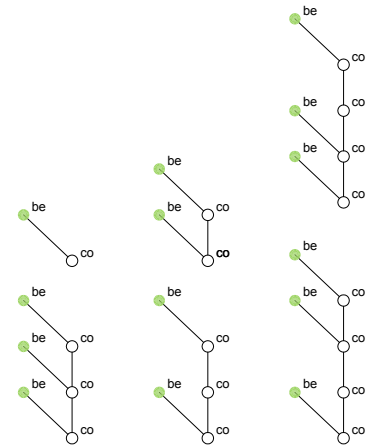

$$be \geq 1 * \{be.d, be.t, be.s\}$$

Rule 2.3.a _ Assignment of single bedrooms (minimum level)

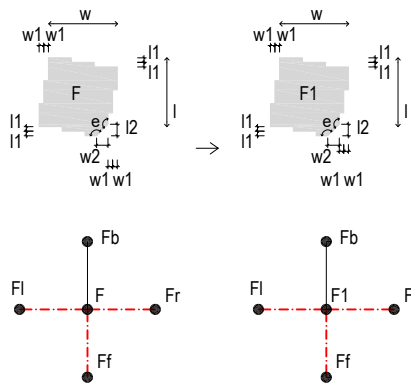

Conditions:

$$Z \supset \{be.sn\} \wedge Z \not\supset \{be.sn\}$$

Dimensions:
 $8m^2 (\pm 10\%) \leq F \leq 30m^2$
 $w, l \geq 2,1m$
 If $Z \supset \{be.s1, be.s2\} \Rightarrow \{be.s1\} \geq 7m^2 \wedge \{be.s2\} \geq 8m^2$
 If $Z \supset \{be.s1, be.s2, be.s3, be.s4\} \Rightarrow \{be.s1, be.s2\} \geq 7m^2 \wedge \{be.s3, be.s4\} \geq 8m^2$
 $0m \leq l1, w1 \leq 1m$
 $l2, w2 \geq 0m$
 $e \in \{135^\circ, 180^\circ\}$

Functions:

$be.s (near_to(x)) = TRUE \vee be.s (close_to(x)) = TRUE, x \in \{be.d, be.t\}$
 $\exists Fb \vee Ff \vee Fr \vee Fl \in \{ext, Cbc\}$
 $\exists Fb \vee Ff \vee Fr \vee Fl \in \{nhs, co, co.p, cl\}$
 $Fb \vee Ff \vee Fr \vee Fl \notin \{hl\}$
 $F \in \{hs\}$
 $F1 \in \{be.s\}$

Description (abbreviated):

$$R2.3a < D2: ext, \{nhs, co, co.p, cl\}, Ff, Fl, F; Z; E > \rightarrow$$

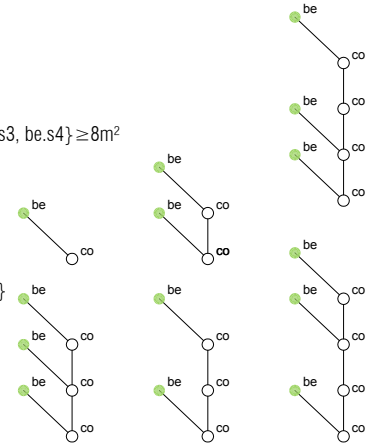

$$be \geq 1 * \{be.d, be.t, be.s\}$$

Rule 2.3.b _ Assignment of single bedrooms (recommended level)

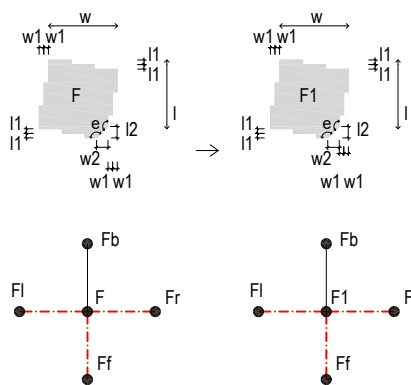

Conditions:

$$Z \supset \{be.sn\} \wedge Z \not\supset \{be.sn\}$$

Dimensions:
 $8.5m^2 (\pm 10\%) \leq F \leq 30m^2$
 $w, l \geq 2,1m$
 If $Z \supset \{be.s1, be.s2\} \Rightarrow \{be.s1\} \geq 7m^2 \wedge \{be.s2\} \geq 8,5m^2$
 If $Z \supset \{be.s1, be.s2, be.s3, be.s4\} \Rightarrow \{be.s1, be.s2\} \geq 7m^2 \wedge \{be.s3, be.s4\} \geq 8,5m^2$
 $0m \leq l1, w1 \leq 1m$
 $l2, w2 \geq 0m$
 $e \in \{135^\circ, 180^\circ\}$

Functions:

$be.s (next_to(x)) = TRUE \vee be.s (close_to(x)) = TRUE, x \in \{be.d, be.t\}$
 $\exists Fb \vee Ff \vee Fr \vee Fl \in \{ext, Cbc\}$
 $\exists Fb \vee Ff \vee Fr \vee Fl \in \{nhs, co, co.p, cl\}$
 $Fb \vee Ff \vee Fr \vee Fl \notin \{hl\}$
 $F \in \{hs\}$
 $F1 \in \{be.s\}$

Description (abbreviated):

$$R2.3b < D2: ext, \{nhs, co, co.p, cl\}, Ff, Fl, F; Z; E > \rightarrow < D2: ext, \{nhs, co, co.p, cl\}, Ff, Fl, be.s; Z + \{be.s\}; E - \{hs\}, E + \{be.s\} >$$

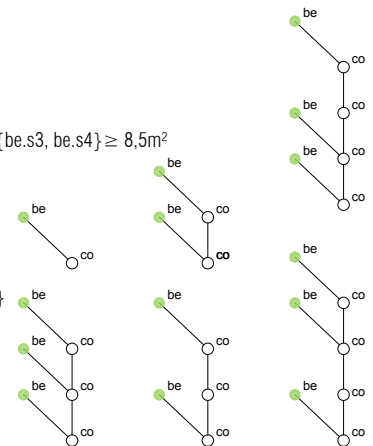

$$be \geq 1 * \{be.d, be.t, be.s\}$$

Rule 2.4 _ Changing from step 2 to step 7 if there is no spaces satisfying rules 2.1 to 2.3

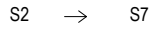
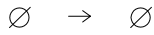

Conditions:

- If $\forall F: F \leq 10,5m^2 (\pm 10\%)$ (Rule 2.1.a) \vee
- If $\forall F: F \leq 12m^2 (\pm 10\%)$ (Rule 2.1.a) \vee
- If $\forall F: F \leq 10,5m^2 (\pm 10\%)$ (Rule 2.2.a) \vee
- If $\forall F: F \leq 14,5m^2 (\pm 10\%)$ (Rule 2.2.b) \vee
- If $\forall F: F \leq 8m^2 (\pm 10\%)$ (Rule 2.3.a) \vee
- If $\forall F: F \leq 8,5m^2 (\pm 10\%)$ (Rule 2.3.b)
- \Rightarrow Rule 7.1.a \vee Rule 7.1.b \vee Rule 7.1.g \vee Rule 7.4.a

Description (abbreviated):

R2.4 < D2: S2 > \rightarrow < D7: S7 >

Rule 2.5 _ Permuting bedroom assignment due to area criteria

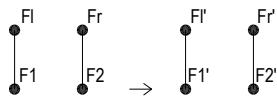

Conditions:

- Dimensions:
- If $F1 > F2 \wedge F1 \in \{be.s\} \wedge F2 \in \{be.t\} \Rightarrow F1' \in \{be.t\} \wedge F2' \in \{be.s\}$
 - If $F1 > F2 \wedge F1 \in \{be.s\} \wedge F2 \in \{be.d\} \Rightarrow F1' \in \{be.d\} \wedge F2' \in \{be.s\}$
 - If $F1 > F2 \wedge F1 \in \{be.s\} \wedge F2 \in \{be.d\} \Rightarrow F1' \in \{be.d\} \wedge F2' \in \{be.s\}$

Function:

- $F1, F2, F1', F2' \in \{be.d, be.t, be.s\}$
- $F1, Fr \in \{nhs, co.p, co, cl\}$
- $F1 \neq F2$

Description (abbreviated):

R2.5 < D2: F1, F1; F2, Fr > \rightarrow < D2: F1', F1; F2', Fr >

Rule 2.6 _ Assignment of main private bathroom (minimum level)

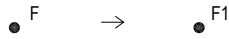

Conditions:

$$Z \supset \{ba.pn\} \wedge Z \supset \{ba.pn\}$$

Dimensions:

$$\text{If } F = \max(A) \wedge A \in \{Xba1, Xba2\} \Rightarrow F = F1$$

Functions:

$$\text{If } E \supset \{Xba1, Xba2\} \wedge Xba1 > Xba2 \Rightarrow F \in \{Xba1\} \wedge F1 \in \{ba.p1\}$$

$$\text{If } E \supset \{Xba1, Xba2\} \wedge Xba2 > Xba1 \Rightarrow F \in \{Xba2\} \wedge F1 \in \{ba.p1\}$$

Description (abbreviated):

$$R2.6 < D2: Xba; Z; E > \rightarrow < D2: ba.p1; Z + \{ba.p1\}; E - \{Xba\}, E + \{ba.p1\} >$$

Rule 2.7.a _ Attribution of new bathrooms placement weight: uba (type a and b)

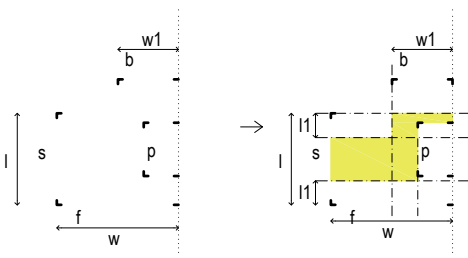

Conditions:

$$Z \supset \{ba.p1\} \wedge Z \supset \{ba.p2\} \wedge Z \supset \{ba.p2\} \vee$$

$$Z \supset \{ba.p1\} \wedge Z \supset \{ba.p3\} \wedge Z \supset \{ba.p3\} \vee$$

$$Z \supset \{ba.p1\} \wedge Z \supset \{ba.g\} \wedge Z \supset \{ba.g\}$$

Dimensions:

$$9.4m \leq l \leq 14m$$

$$5.7m \leq w \leq 18.5m$$

$$3m \leq w1 \leq 7.2m$$

$$l1 = 3m$$

Description (abbreviated):

$$R2.7a < D2: l, w, w1; \emptyset > \rightarrow < D2: l, w, w1, l1; uba >$$

Note:

----- auxiliary lines

Rule 2.7.b _ Attribution of new bathrooms placement weight: uba (type c and d)

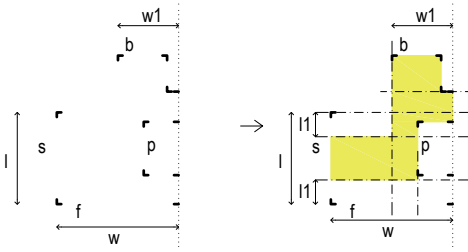

Conditions:

$$Z \supset \{ba.p1\} \wedge Z \supset \{ba.p2\} \wedge Z \supset \{ba.p2\} \vee$$

$$Z \supset \{ba.p1\} \wedge Z \supset \{ba.p3\} \wedge Z \supset \{ba.p3\} \vee$$

$$Z \supset \{ba.p1\} \wedge Z \supset \{ba.g\} \wedge Z \supset \{ba.g\}$$

Dimensions:

$$9.4m \leq l \leq 14m$$

$$5.7m \leq w \leq 18.5m$$

$$3.7m \leq w1 \leq 7.2m$$

$$l1 = 3m$$

Description (abbreviated):

$$R2.7b < D2: l, w, w1; \emptyset > \rightarrow < D2: l, w, w1, l1; uba >$$

Note:

----- auxiliary lines

Rule 2.7.c _ Assignment of area to place new bathrooms, extending an existing bathroom

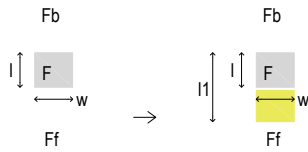

Conditions:

$Z \supset \{ba.p2\} \wedge Z \not\supset \{ba.p2\} \vee$
 $Z \supset \{ba.p3\} \wedge Z \not\supset \{ba.p3\} \vee$
 $Z \supset \{ba.g\} \wedge Z \not\supset \{ba.g\}$

Dimensions:
 $1m \leq l \leq 2m$
 $1m \leq w \leq 2m$
 $l1 \leq 3m$

Function:
 $F \in \{Xba, ba.p1\}$
 $Fb \in \{ext\}$
 $Ff \in \{nhs\}$

Rule 2.8.a _ Assignment of second private bathroom (minimum level)

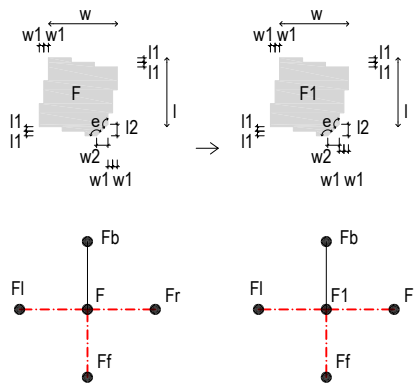

Conditions:

$Z \supset \{ba.p1\} \wedge Z \supset \{ba.p2\} \wedge Z \not\supset \{ba.p2\}$

Dimensions:
 If $nhab \leq 6 \Rightarrow 5m^2(\pm 10\%) \geq F \geq 1m^2$
 If $nhab \geq 7 \Rightarrow 5m^2(\pm 10\%) \geq F \geq 2,5m^2$
 $l, w \geq 1m$
 $0m \leq l1, w1 \leq 1m$
 $l2, w2 \geq 0m$
 $e \in \{135^\circ, 180^\circ\}$

Functions:

$F \in \{nhs\}$
 $F(\text{inside}(x)) = \text{TRUE}, x \in \{uba\}$
 $\exists | (\text{passage_to}(y)) | F(\text{passage_to}(y)) = \text{TRUE}, y \in \{Ff, Fb, Fl, Ff\}$
 $F(\text{next_to}(t)) = \text{TRUE}, t \in \{be.s, be.d, be.t\}$
 $\vee F(\text{close_to}(t)) = \text{TRUE}, t \in \{be.s, be.d, be.t\}$
 $F1 \in \{ba.p2\}$

Description (abbreviated):

$R2.8a < D2: Fb, Ff, Fr, Fl, F; Z; E > \rightarrow$
 $< D2: Fb, Ff, Fr, Fl; ba.p2; Z' + \{ba.p2\}; E - \{nhs\}, E + \{ba.p2\} >$

Rule 2.8.b _ Assignment of second private bathroom (recommended level)

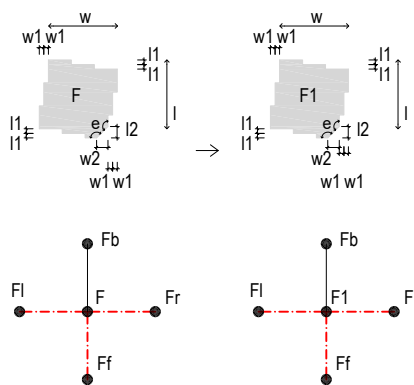

Conditions:

$Z \supset \{ba.p1\} \wedge Z \supset \{ba.p2\} \wedge Z \not\supset \{ba.p2\}$

Dimensions:
 If $nhab \leq 5 \Rightarrow 5m^2(\pm 10\%) \geq F \geq 2m^2$
 If $nhab \geq 6 \Rightarrow 5m^2(\pm 10\%) \geq F \geq 3m^2$
 $l, w \geq 1m$
 $0m \leq l1, w1 \leq 1m$
 $l2, w2 \geq 0m$
 $e \in \{135^\circ, 180^\circ\}$

Functions:

$F \in \{nhs\}$
 $F(\text{inside}(x)) = \text{TRUE}, x \in \{uba\}$
 $\exists | (\text{passage_to}(y)) | F(\text{passage_to}(y)) = \text{TRUE}, y \in \{Ff, Fb, Fl, Ff\}$
 $F(\text{next_to}(t)) = \text{TRUE}, t \in \{be.s, be.d, be.t\}$
 $\vee F(\text{close_to}(t)) = \text{TRUE}, t \in \{be.s, be.d, be.t\}$
 $F1 \in \{ba.p2\}$

Description (abbreviated):

$R2.8a < D2: Fb, Ff, Fr, Fl, F; Z; E > \rightarrow$
 $< D2: Fb, Ff, Fr, Fl; ba.p2; Z' + \{ba.p2\}; E - \{nhs\}, E + \{ba.p2\} >$

Rule 2.9 _ Create a second private bathroom (next to side wall or on a parallel wall)

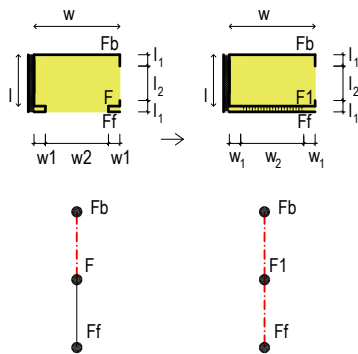

Conditions:

$$Z \supset \{ba.p1\} \wedge Z \supset \{ba.p2\} \wedge Z \not\supset \{ba.p2\}$$

Dimensions:

$$1m \leq l \leq 2.6m$$

$$1m \leq w \leq 4m$$

$$0.1m \leq w1, l1 \leq 3m$$

$$0.8m \leq w2 \leq 3.8m$$

$$0m \leq l2 \leq 3.8m$$

Function:

$$F \in \{nhs\}$$

$$Fb, Ff \in \{nhs, hs, be.d, be.t, be.s, li, di, li/di, ho, mr, ki\}$$

$$F(\text{inside}(x)) = \text{TRUE}, x \in \{uba\}$$

$$F(\text{adjacent_to}(x)) = \text{TRUE}, x \in \{usi\}$$

$$F1 \in \{ba.p2\}$$

Description (abbreviated):

$$R2.9 < D2: l; F; Z; E > \rightarrow$$

$$< D2: l; ba.p2; Z' + \{ba.p2\}; E - \{nhs\}; E + \{ba.p2\} >$$

Rule 2.10 _ Create a second private bathroom (next to side wall)

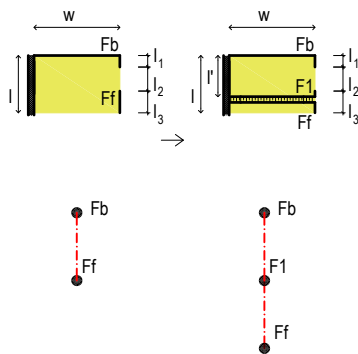

Conditions:

$$Z \supset \{ba.p1\} \wedge Z \supset \{ba.p2\} \wedge Z \not\supset \{ba.p2\}$$

Dimensions:

$$1.2m \leq l \leq 1.5m$$

$$1m \leq l' \leq 1.5m$$

$$1m \leq w \leq 4m$$

$$0.1m \leq l1, l3 \leq 2m$$

$$0m \leq l2 \leq 1.2m$$

Function:

$$Fb, Ff \in \{nhs, hs, be.d, be.t, be.s, li, di, li/di, ho, mr, ki\}$$

$$F(\text{inside}(x)) = \text{TRUE}, x \in \{uba\}$$

$$F(\text{adjacent_to}(x)) = \text{TRUE}, x \in \{usi\}$$

$$F1 \in \{ba.p2\}$$

Description (abbreviated):

$$R2.10 < D2: Fb, Ff; Z; E > \rightarrow$$

$$< D2: Fb, ba.p2, Ff; Z' + \{ba.p2\}; E + \{ba.p2\} >$$

Rule 2.11 _ Create a second private bathroom (next to side wall)

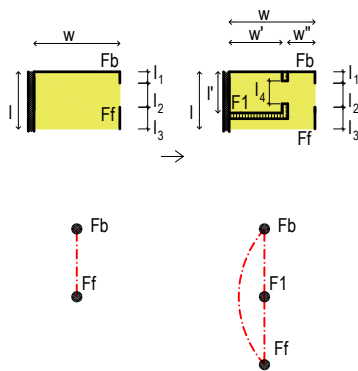

Conditions:

$$Z \supset \{ba.p1\} \wedge Z \supset \{ba.p2\} \wedge Z \not\supset \{ba.p2\}$$

Dimensions:

$$1.2m \leq l \leq 1.5m$$

$$1m \leq l' \leq 1.5m$$

$$1m \leq w \leq 4m$$

$$1m \leq w' \leq 2.5m$$

$$0.9m \leq w'' \leq 1.2m$$

$$0.1m \leq l1, l3 \leq 2m$$

$$0m \leq l2 \leq 1.2m$$

$$l4 \in \{0.8m\}$$

Function:

$$Fb, Ff \in \{nhs, hs, be.d, be.t, be.s, li, di, li/di, ho, mr, ki\}$$

$$F(\text{inside}(x)) = \text{TRUE}, x \in \{uba\}$$

$$F(\text{adjacent_to}(x)) = \text{TRUE}, x \in \{usi\}$$

$$F1 \in \{ba.p2\}$$

Description (abbreviated):

$$R2.9 < D2: Fb, Ff; Z; Z' > \rightarrow$$

$$< D2: Fb, ba.p2, Ff; Z' + \{ba.p2\}; E + \{ba.p2\} >$$

Private bathrooms assignment

Rule 2.12 _ Create a second private bathroom (next to a wall parallel to the side wall)

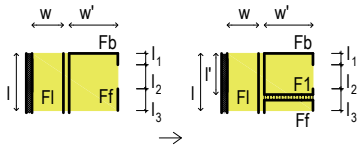

Conditions:

$$Z \supset \{ba.p1\} \wedge Z \supset \{ba.p2\} \wedge Z \not\supset \{ba.p2\}$$

Dimensions:

- $1.2m \leq l \leq 1.5m$
- $1m \leq l' \leq 1.5m$
- $1m \leq w, w' \leq 4m$
- $0.1m \leq l1, l3 \leq 2m$
- $0m \leq l2 \leq 1.2m$

Function:

- $Fb, Ff, F1 \in \{nhs, hs, be.d, be.t, be.s, li, di, li/di, ho, mr, ki\}$
- $F(inside(x)) = TRUE, x \in \{uba\}$
- $F(adjust_to(x)) = TRUE, x \in \{usi\}$
- $F1 \in \{ba.p2\}$

Description (abbreviated):

$$R2.12 \langle D2: Fb, Ff, F1; Z; E \rangle \rightarrow \langle D2: Fb, ba.p2, Ff, F1; Z' + \{ba.p2\}; E + \{ba.p2\} \rangle$$

Rule 2.13 _ Create a second private bathroom (next to a wall parallel to the side wall)

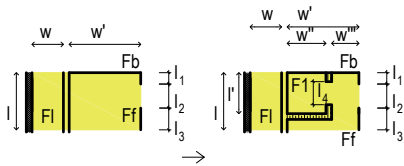

Conditions:

$$Z \supset \{ba.p1\} \wedge Z \supset \{ba.p2\} \wedge Z \not\supset \{ba.p2\}$$

Dimensions:

- $1.2m \leq l \leq 1.5m$
- $1m \leq l' \leq 1.5m$
- $1m \leq w, w' \leq 4m$
- $1m \leq w'' \leq 2.5m$
- $0.9m \leq w''' \leq 1.2m$
- $0.1m \leq l1, l3 \leq 2m$
- $0m \leq l2 \leq 1.2m$
- $l4 \in \{0.8m\}$

Function:

- $Fb, Ff, F1 \in \{nhs, hs, be.d, be.t, be.s, li, di, li/di, ho, mr, ki\}$
- $F(inside(x)) = TRUE, x \in \{uba\}$
- $F(adjust_to(x)) = TRUE, x \in \{usi\}$
- $F1 \in \{ba.p2\}$

Description (abbreviated):

$$R2.13 \langle D2: Fb, Ff, F1; Z; E \rangle \rightarrow \langle D2: Fb, ba.p2, Ff, F1; Z' + \{ba.p2\}; E + \{ba.p2\} \rangle$$

Rule 2.14 _ Create a second bathroom (in nhs)

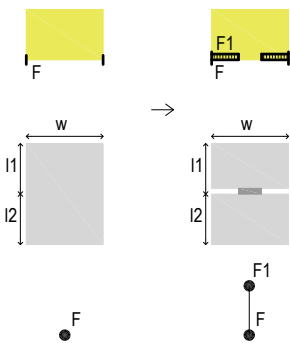

Conditions:

$$Z \supset \{ba.p1\} \wedge Z \supset \{ba.p2\} \wedge Z \not\supset \{ba.p2\} \vee Z \supset \{ba.g\} \wedge Z \not\supset \{ba.g\}$$

Dimensions:

- $l2, w \geq 1m$
- $1m \leq l1 \leq 1.5m$

Function:

- $F \in \{nhs, co, co.s, co.p\}$
- $F(inside(x)) = TRUE, x \in \{uba\}$
- $F1 \in \{ba.p2, ba.g\}$

Description (abbreviated):

$$R2.14 \langle D2: F; Z; E \rangle \rightarrow \langle D2: F, \{ba.p2, ba.g\}; Z' + \{ba.p2, ba.g\}; E + \{ba.p2, ba.g\} \rangle$$

Rule 2.15 _ Create a second bathroom (inside a bedroom)

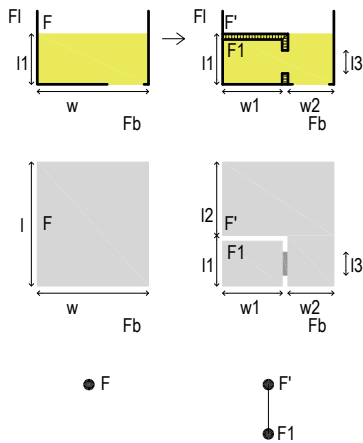

Conditions:

$$Z \supset \{ba.p1\} \wedge Z \supset \{ba.p2\} \wedge Z \not\supset \{ba.p2\}$$

Dimensions:

$$l \geq 4,4m$$

$$If \text{minimum_level} \wedge F \in \{be.d\} \Rightarrow w, l2 \geq 2,7m \wedge F \geq 10,5m^2$$

$$If \text{minimum_level} \wedge F \in \{be.t\} \Rightarrow w \geq 2,5m \wedge l2 \geq 2,1m \wedge F \geq 10,5m^2$$

$$If \text{minimum_level} \wedge F \in \{be.s\} \Rightarrow w \geq 2,5m \wedge l2 \geq 2,1m \wedge F \geq 8m^2$$

$$w2 \geq 1m$$

$$1m \leq l1, w1 \leq 1,5m$$

$$l3 \in \{0.8m, 0.9m\}$$

Function:

$$F, F' \in \{be.d, be.t, be.s\}$$

$$F = F'$$

$$Fb \in \{nhs, co, co.s, co.p\}$$

$$F1 \neq ext$$

$$F1 (inside(x)) = TRUE, x \in \{uba\}$$

$$F1 \in \{ba.p2\}$$

Description (abbreviated):

$$R2.15 < D2: F; Z; E > \rightarrow$$

$$< D2: F, \{ba.p2\}; Z + \{ba.p2\}; E + \{ba.p2\} >$$

Rule 2.16.a _ Erasing the new bathrooms placement weight: uba (type a and b)

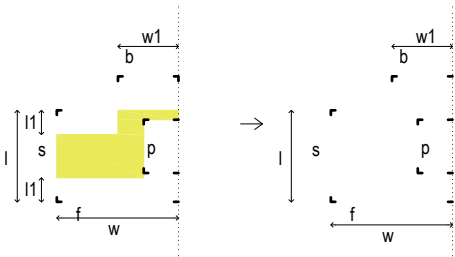

Conditions:

$$Z \supset \{ba.pn, ba.g\} \wedge Z \not\supset \{ba.pn, ba.g\}$$

Dimensions:

$$9.4m \leq l \leq 14m$$

$$5.7m \leq w \leq 18.5m$$

$$3m \leq w1 \leq 7.2m$$

$$l1 = 3m$$

Description (abbreviated):

$$R2.16a < D2: l; uba > \rightarrow < D2: l1, l2; \emptyset >$$

Rule 2.16.b _ Erasing the new bathrooms placement weight: uba (type c and d)

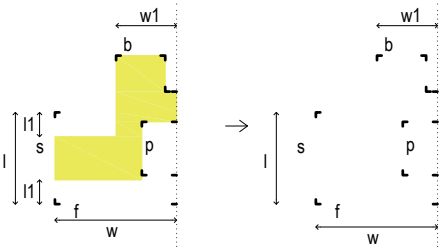

Conditions:

$$Z \supset \{ba.pn, ba.g\} \wedge Z \not\supset \{ba.pn, ba.g\}$$

Dimensions:

$$9.4m \leq l \leq 14m$$

$$5.7m \leq w \leq 18.5m$$

$$3.7m \leq w1 \leq 7.2m$$

$$l1 = 3m$$

Description (abbreviated):

$$R2.16b < D2: l; uba > \rightarrow < D2: l1, l2; \emptyset >$$

Note:

----- auxiliary lines

Rule 2.17 _ Permuting the function of a bedroom which gives passage to private bathroom

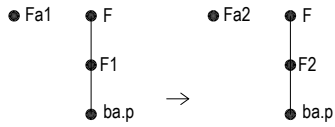

Conditions:

Function:
 ba.p (passage_to(x))=FALSE, $x \in \{F\}$
 $F \in \{nhs, co, co.s, co.p, hl\}$
 // $F1 \in \{be.t\} \wedge Fa1 \in \{be.d\} \Rightarrow F2 \in \{be.d\} \wedge Fa2 \in \{be.t\}$
 // $F1 \in \{be.s\} \wedge Fa1 \in \{be.d\} \Rightarrow F2 \in \{be.d\} \wedge Fa2 \in \{be.s\}$

Description (abbreviated):

R2.17 < D2: F, F1, ba.p, Fa1 > \rightarrow
 < D2: F, F2, ba.p, Fa2 >

Rule 2.18 _ Changing from step 2 to step 7 if there is no spaces satisfying rules 2.8 to 2.15

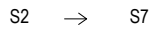
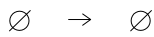

Conditions:

// $\forall F: F \leq 2,5m^2 (\pm 10\%)$ (Rule 2.8.a) \vee
 // $\forall F: F \leq 3m^2 (\pm 10\%)$ (Rule 2.8.b) \vee
 \Rightarrow Rules 7.1 \vee Rules 7.4

Description (abbreviated):

R2.18 < D2: S2 > \rightarrow < D7: S7 >

Rule 2.19 _ Changing from step 2 to step 3

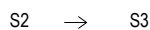
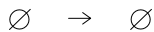

Conditions:

// $Z \supset \{be.d\} \wedge Z \supset \{be.d\} \wedge E \supset \{be.d\}$
 // $Z \supset \{be.tn\} \wedge Z \supset \{be.tn\} \wedge E \supset \{be.tn\}$
 // $Z \supset \{be.sn\} \wedge Z \supset \{be.sn\} \wedge E \supset \{be.sn\}$
 // $Z \supset \{ba.pn\} \wedge Z \supset \{ba.pn\} \wedge E \supset \{ba.pn\}$

Description (abbreviated):

R2.19 < D2: S2 > \rightarrow < D3: S3 >

Rule 3.1.a _ Assignment of living room (minimum level)

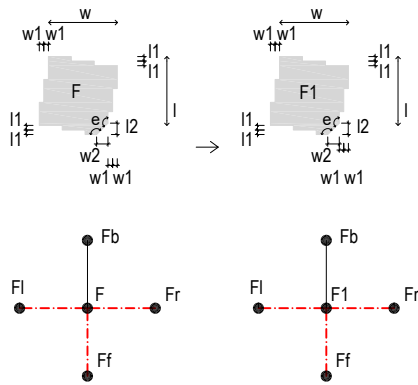

Conditions:

$$Z \supset \{li\} \wedge Z \not\supset \{li\}$$

Dimensions:

- If $nhab \leq 6 \Rightarrow 13m^2 (\pm 10\%) \leq F \leq 35m^2$
- If $nhab = 7 \Rightarrow 16m^2 (\pm 10\%) \leq F \leq 35m^2$
- If $nhab \geq 8 \Rightarrow 19.5m^2 (\pm 10\%) \leq F \leq 35m^2$
- $w, l \geq 3m$
- $l \leq 2 * w$
- $0m \leq l1, w1 \leq 1m$
- $l2, w2 \geq 0m$
- $e \in \{135^\circ, 180^\circ\}$

Functions:

- $Fb \in \{ext\}$
- $\exists Ff \vee Fr \vee Ff \in \{nhs, co, co.p, hl\}$
- $F \in \{hs\}$
- If $\{strategy1\} \Rightarrow li (next_to(x))=TRUE \vee li (close_to(x))=TRUE, x \in \{ki, hl\}$
- If $\{strategy2\} \Rightarrow li (next_to(y))=TRUE \vee li (close_to(y))=TRUE, y \in \{di, hl, co, co.s\}$
- $F1 \in \{li\}$

Description (abbreviated):

$$R3.1a < D3: ext, \{nhs, co, co.p, hl\}, Ff, Ff; F; Z; E > \rightarrow < D3: ext, \{nhs, co, co.p, hl\}, Ff, Ff; li; Z' + \{li\}; E - \{hs\}, E + \{li\} >$$

Rule 3.1.b _ Assignment of living room (minimum level)

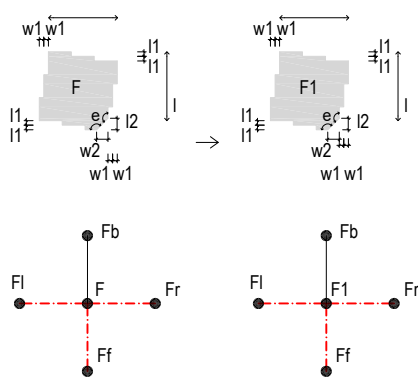

Conditions:

$$Z \supset \{li\} \wedge Z \not\supset \{li\}$$

Dimensions:

- If $nhab = 2 \Rightarrow 11.5m^2 (\pm 10\%) \leq F \leq 35m^2$
- If $nhab = 3 \Rightarrow 13m^2 (\pm 10\%) \leq F \leq 35m^2$
- If $nhab = \{4,5\} \Rightarrow 16m^2 (\pm 10\%) \leq F \leq 35m^2$
- If $nhab = 6 \Rightarrow F \geq 19.5m^2 (\pm 10\%) \leq F \leq 35m^2$
- If $nhab = 7 \Rightarrow F \geq 22.5m^2 (\pm 10\%) \leq F \leq 35m^2$
- If $nhab \geq 8 \Rightarrow F \geq 26m^2 (\pm 10\%) \leq F \leq 35m^2$
- $w, l \geq 3.5m$
- $l \leq 2 * w$
- $0m \leq l1, w1 \leq 1m$
- $l2, w2 \geq 0m$
- $e \in \{135^\circ, 180^\circ\}$

Functions:

- $Fb \in \{ext\}$
- $\exists Ff \vee Fr \vee Ff \in \{nhs, co, co.p, hl\}$
- $F \in \{hs\}$
- If $\{strategy1\} \Rightarrow li (next_to(x))=TRUE \vee li (close_to(x))=TRUE, x \in \{ki, hl\}$
- If $\{strategy2\} \Rightarrow li (next_to(y))=TRUE \vee li (close_to(y))=TRUE, y \in \{di, hl, co, co.s\}$
- $F1 \in \{li\}$

Description (abbreviated):

$$R3.1b < D3: ext, \{nhs, co, co.p, hl\}, Ff, Ff; F; Z; E > \rightarrow < D3: ext, \{nhs, co, co.p, hl\}, Ff, Ff; li; Z' + \{li\}; E - \{hs\}, E + \{li\} >$$

Rule 3.2.a _ Assignment of dining room (minimum level)

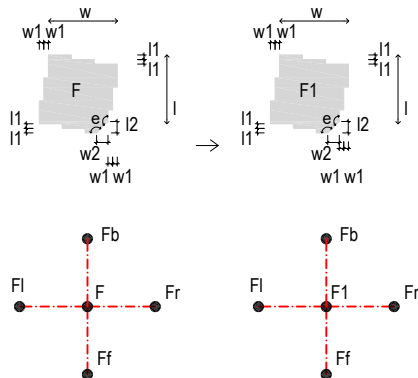

Conditions:

$$Z \supset \{di\} \wedge Z \not\supset \{di\}$$

Dimensions:

- If $nhab = (5+x) \Rightarrow (7m^2 + 1m^2(x-5)) (\pm 10\%) \leq F \leq 35m^2$
- If $7m^2 < F < 9m^2 \Rightarrow l \vee w \geq 2.1m$
- If $9.5m^2 < F < 12m^2 \Rightarrow l, w \geq 2.4m$
- $F \geq 12m^2 \Rightarrow l, w \geq 2.7m$
- $l \leq 2 * w$
- $0m \leq l1, w1 \leq 1m$
- $l2, w2 \geq 0m$
- $e \in \{135^\circ, 180^\circ\}$

Functions:

- $\exists Ff \vee Fr \vee Ff \vee Fb \in \{nhs, co, co.p, hl\}$
- $F \in \{hs\} \vee F \in \{nhs\} // (F (passage_to(x))=TRUE, x \in \{li\})$
- If $\{strategy1\} \Rightarrow di (next_to(x))=TRUE \vee di (close_to(x))=TRUE, x \in \{ki\}$
- If $\{strategy2\} \Rightarrow di (next_to(y))=TRUE \vee di (close_to(y))=TRUE, y \in \{li, hl, co, co.s, ki\}$
- $F1 \in \{di\}$

Description (abbreviated):

$$R3.2a < D3: ext, \{nhs, co, co.p, hl\}, Ff, Ff; F; Z; E > \rightarrow < D3: ext, \{nhs, co, co.p, hl\}, Ff, Ff; di; Z' + \{di\}; E - \{hs, nhs\}, E + \{di\} >$$

Rule 3.2.b _ Assignment of dining room (recommended level)

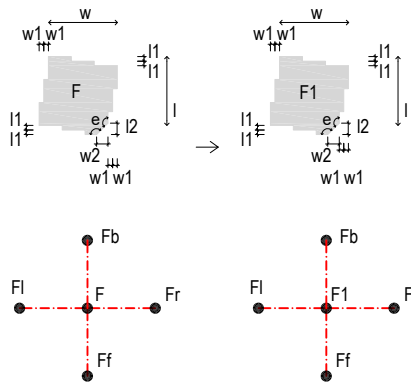

Conditions:

$$Z \supset \{di\} \wedge Z \not\supset \{di\}$$

Dimensions:

$$\text{If } nhab \geq 2 \Rightarrow F \geq (7.5m^2 + 1m^2(n-2)) (\pm 10\%) \leq F \leq 35m^2$$

$$7m^2 < F < 9m^2 \Rightarrow l, w \geq 2,1m$$

$$9,5m^2 < F < 12m^2 \Rightarrow l, w \geq 2,4m$$

$$F \geq 12m^2 \Rightarrow l, w \geq 2,7m$$

$$l \leq 2 * w$$

$$0m \leq l1, w1 \leq 1m$$

$$l2, w2 \geq 0m$$

$$e \in \{135^\circ, 180^\circ\}$$

Functions:

$$\exists Ff \vee Fr \vee Ff \vee Fb \in \{nhs, co, co.p, hl\}$$

$$F \in \{hs\} \vee F \in \{nhs\} \text{ If } (passage_to(x)) = TRUE, x \in \{li\}$$

$$\text{If } \{strategy1\} \Rightarrow di (next_to(x)) = TRUE \vee di (close_to(x)) = TRUE, x \in \{ki\}$$

$$\text{If } \{strategy2\} \Rightarrow di (next_to(y)) = TRUE \vee di (close_to(x)) = TRUE, y \in \{li, hl, co, co.s, ki\}$$

$$F1 \in \{di\}$$

Description (abbreviated):

$$R3.2b < D3: ext, \{nhs, co, co.p, hl\}, Ff, Ff; F; Z; E > \rightarrow$$

$$< D3: ext, \{nhs, co, co.p, hl\}, Ff, Ff; di; Z' + \{di\}; E - \{hs, nhs\}, E + \{di\} >$$

Rule 3.3.a _ Assignment of combined living/dining room (minimum level)

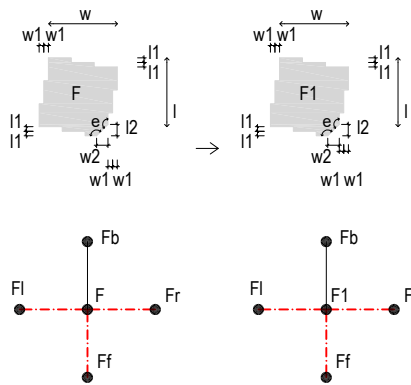

Conditions:

$$Z \supset \{di/li, li, di\} \wedge Z \not\supset \{di/li, li, di\}$$

Dimensions:

$$\text{If } nhab = \{1,2\} \Rightarrow 12m^2 (\pm 10\%) \leq F \leq 35m^2$$

$$\text{If } npersons = 3 \Rightarrow 15m^2 (\pm 10\%) \leq F \leq 35m^2$$

$$\text{If } npersons = 4 \Rightarrow 17.5m^2 (\pm 10\%) \leq F \leq 35m^2$$

$$\text{If } npersons = 5 \Rightarrow 19m^2 (\pm 10\%) \leq F \leq 35m^2$$

$$\text{If } npersons = 6 \Rightarrow 21m^2 (\pm 10\%) \leq F \leq 35m^2$$

$$\text{If } npersons = 7 \Rightarrow 24m^2 (\pm 10\%) \leq F \leq 35m^2$$

$$\text{If } npersons \geq 8 \Rightarrow 29m^2 (\pm 10\%) \leq F \leq 35m^2$$

$$l, w \geq 3m$$

$$l \leq 2 * w$$

$$0m \leq l1, w1 \leq 1m$$

$$l2, w2 \geq 0m$$

$$e \in \{135^\circ, 180^\circ\}$$

Functions:

$$F \in \{hs\}$$

$$Fb \in \{ext\} \wedge Ff \vee Fr \vee Ff \in \{nhs, co, co.s, hl\}$$

$$\text{If } \{strategy1\} \Rightarrow F (next_to(x)) = TRUE, x \in \{ki\}$$

$$\text{If } \{strategy2\} \Rightarrow F (next_to(y)) = TRUE, y \in \{hl, co, co.s\}$$

$$F1 \in \{li/di\}$$

Description (abbreviated):

$$R3.3a < D3: ext, \{nhs, co, co.p, hl\}, Ff, Ff; F; Z; E > \rightarrow$$

$$< D3: ext, \{nhs, co, co.p, hl\}, Ff, Ff; li/di;$$

$$Z' + \{li/di\}; E - \{hs\}, E + \{li/di\} >$$

Rule 3.3.b _ Assignment of combined living/dining room (recommended level)

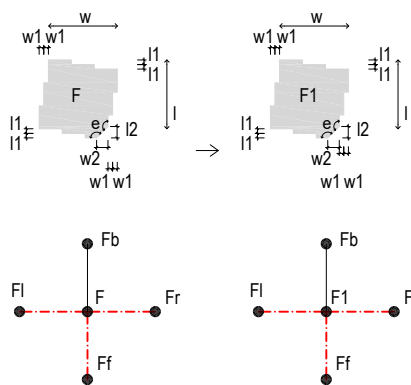

Conditions:

$$Z \supset \{di/li, li, di\} \wedge Z \not\supset \{di/li, li, di\}$$

Dimensions:

$$\text{If } nhab = \{1,2\} \Rightarrow 18.5m^2 (\pm 10\%) \leq F \leq 35m^2$$

$$\text{If } npersons = 3 \Rightarrow 20.5m^2 (\pm 10\%) \leq F \leq 35m^2$$

$$\text{If } npersons = 4 \Rightarrow 23.5m^2 (\pm 10\%) \leq F \leq 35m^2$$

$$\text{If } npersons = 5 \Rightarrow 24m^2 (\pm 10\%) \leq F \leq 35m^2$$

$$\text{If } npersons = 6 \Rightarrow 26.5m^2 (\pm 10\%) \leq F \leq 35m^2$$

$$\text{If } npersons = 7 \Rightarrow 32.5m^2 (\pm 10\%) \leq F \leq 40m^2$$

$$\text{If } npersons = 8 \Rightarrow 35.5m^2 (\pm 10\%) \leq F \leq 40m^2$$

$$\text{If } npersons = 9 \Rightarrow 36m^2 (\pm 10\%) \leq F \leq 40m^2$$

$$l, w \geq 3.5m$$

$$l \leq 2 * w$$

$$0m \leq l1, w1 \leq 1m$$

$$l2, w2 \geq 0m$$

$$e \in \{135^\circ, 180^\circ\}$$

Functions:

$$F \in \{hs\}$$

$$Fb \in \{ext\} \wedge Ff \vee Fr \vee Ff \in \{nhs, co, co.s, hl\}$$

$$\text{If } \{strategy1\} \Rightarrow F (next_to(x)) = TRUE, x \in \{ki\}$$

$$\text{If } \{strategy2\} \Rightarrow F (next_to(y)) = TRUE, y \in \{hl, co, co.s\}$$

$$F1 \in \{li/di\}$$

Description (abbreviated):

$$R3.3b < D3: ext, \{nhs, co, co.p, hl\}, Ff, Ff; F; Z; E > \rightarrow$$

$$< D3: ext, \{nhs, co, co.p, hl\}, Ff, Ff; li/di;$$

$$Z' + \{li/di\}; E - \{hs\}, E + \{li/di\} >$$

Rule 3.4 _ Assignment of isolated home office (by request of the inhabitant)

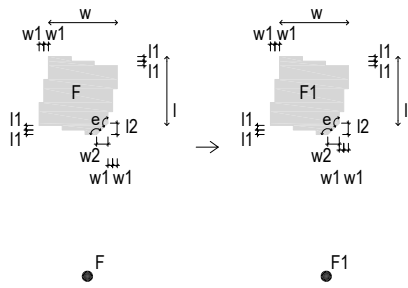

Conditions:
 $Z \supset \{ho\} \wedge Z^D \{ho\}$

Dimensions:
 $7m^2 (\pm 10\%) \leq F \leq 30m^2$
 $w, l \geq 2,1m$
 $0m \leq l1, w1 \leq 1m$
 $l2, w2 \geq 0m$
 $e \in \{135^\circ, 180^\circ\}$

Functions:
 $F \in \{hs\} \vee F \in \{nhs\} // F(\text{passage_to}(x)) = \text{TRUE}, x \in \{li, li/di, be.c, be.t\}$
 $F1 \in \{ho\}$

Description (abbreviated):

R3.4 < D3: ext, {nhs, co, co.p, co.s, hl}, F, F1; F; Z > →
 < D3: ext, {nhs, co, co.p, co.s, hl}, F, F1; ho; Z' + {ho}; E - {hs, nhs}, E + {ho} >

Rule 3.5.a _ Assignment of delimited home office (minimum level)

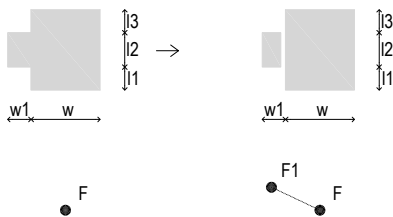

Conditions:
 $Z \supset \{ho\} \wedge Z^D \{ho\}$

Dimensions:
 If $nhab \geq 2 \Rightarrow 2m^2 \leq F1 \leq 4m^2 (\pm 10\%)$
 $1m \leq w, w1, l2 \leq 5m$
 $0m \leq l1, l3 \leq 3.5m$

Description (abbreviated):

R3.5a < D3: F; Z; E > → < D3: F, F1; Z' + {ho}; E + {ho} >

Function:
 $F \in \{li, di, li/di, be.c, co, co.s, hl, nhs\}$
 $F1 \in \{ho\}$

Rule 3.5.b _ Assignment of delimited home office (recommended level)

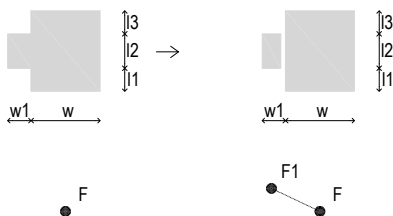

Conditions:
 $Z \supset \{ho\} \wedge Z^D \{ho\}$

Dimensions:
 If $nhab \geq 2 \Rightarrow 4m^2 \leq F \leq 6m^2 (\pm 10\%)$
 $1m \leq w, w1, l2 \leq 5m$
 $0m \leq l1, l3 \leq 3.5m$

Description (abbreviated):

R3.5b < D3: F; Z; E > → < D3: F, F1; Z' + {ho}; E + {ho} >

Function:
 $F \in \{li, di, li/di, be.c, co, co.s, hl, nhs\}$
 $F1 \in \{ho\}$

Rule 3.6.a _ Adding an home office space to an assigned living room (minimum level)

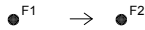

Conditions:

$$Z \supset \{ho\} \wedge Z \not\supset \{ho\}$$

Dimensions:

$$\text{If } nhab \leq 6 \Rightarrow F2 \geq 14m^2 (\pm 10\%)$$

$$\text{If } nhab = 7 \Rightarrow F2 \geq 17m^2 (\pm 10\%)$$

$$\text{If } nhab \geq 8 \Rightarrow F2 \geq 20.5m^2 (\pm 10\%)$$

Functions:

$$F1 \in \{li\}$$

$$F2 \in \{li/ho\}$$

Description (abbreviated):

$$R3.6a < D3: F1; Z; E > \rightarrow$$

$$< D3: F2; Z' - \{li\}, Z' + \{li/ho\}; E - \{li\}, E + \{li/ho\} >$$

Rule 3.6.b _ Assignment of living room + included home office (recommended level)

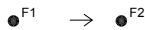

Conditions:

$$Z \supset \{ho\} \wedge Z \not\supset \{ho\}$$

Dimensions:

$$\text{If } nhab = 2 \Rightarrow F2 \geq 14.5m^2 (\pm 10\%)$$

$$\text{If } nhab = 3 \Rightarrow F2 \geq 16m^2 (\pm 10\%)$$

$$\text{If } nhab = \{4,5\} \Rightarrow F2 \geq 19m^2 (\pm 10\%)$$

$$\text{If } nhab = 6 \Rightarrow F2 \geq 22.5m^2 (\pm 10\%)$$

$$\text{If } nhab = 7 \Rightarrow F2 \geq 25.5m^2 (\pm 10\%)$$

$$\text{If } nhab \geq 8 \Rightarrow F2 \geq 29m^2 (\pm 10\%)$$

Functions:

$$F1 \in \{li\}$$

$$F2 \in \{li/ho\}$$

Description (abbreviated):

$$R3.6b < D3: F1; Z; E > \rightarrow$$

$$< D3: F2; Z' - \{li\}, Z' + \{li/ho\}; E - \{li\}, E + \{li/ho\} >$$

Rule 3.7 _ Adding an home office space to an assigned bedroom of occasional use

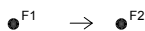

Conditions:

Functions:

$$F1 \in \{be.t\} \wedge \text{percentage_occupation}(F1) \leq 50\% \Rightarrow F2 \in \{be.t/ho\}$$

$$F1 \in \{be.s\} \wedge \text{percentage_occupation}(F1) \leq 50\% \Rightarrow F2 \in \{be.s/ho\}$$

Description (abbreviated):

$$R3.7 < D3: F1; Z; E > \rightarrow$$

$$< D3: F2; Z' - \{be.t, be.d\}, Z' + \{be.t/ho, be.d/ho\}; E - \{be.t, be.d\}, E + \{be.t/ho, be.d/ho\} >$$

Rule 3.8 _ Assignment of isolated media room (recommended level)

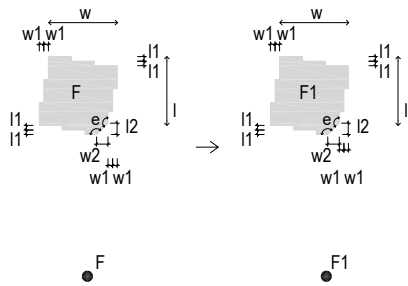

Conditions:
 $Z \supset \{mr\} \wedge Z \not\supset \{mr\}$

Dimensions:
 If $nhab = \{4,5,6\} \Rightarrow 12m^2 (\pm 10\%) \leq F \leq 30m^2$
 If $nhab \geq 7 \Rightarrow 14m^2 (\pm 10\%) \leq F \leq 30m^2$
 $l, w \geq 3,5m$
 $0m \leq l1, w1 \leq 1m$
 $l2, w2 \geq 0m$
 $e \in \{135^\circ, 180^\circ\}$

Functions:
 $F \in \{hs\} \vee F \in \{nhs\} // F(\text{passage_to}(x)) = \text{TRUE}, x \in \{li, li/di\}$
 $\exists Fb \vee Ff \vee Fr \vee Fi \in \{nhs, co, co.s, hl\}$
 $F1 \in \{mr\}$

Description (abbreviated):

$R3.8 < D3: \{nhs, co, co.s, hl\}, Ff, Fi, Fr, F; Z; E > \rightarrow$
 $< D3: \text{ext}, \{nhs, co, co.p, co.s, hl\}, Ff, Fi, Fr, mr; Z' + \{mr\}; E - \{hs, nhs\}, E + \{mr\} >$

Rule 3.9 _ Adding a media room to an assigned living room (recommended level)

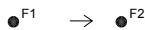

Conditions:

$Z \supset \{mr\} \wedge Z \not\supset \{mr\}$

Dimensions:
 If $nhab = 2 \Rightarrow F1 \geq 11.5m^2 + 2m^2 (\pm 10\%)$
 If $nhab = 3 \Rightarrow F1 \geq 13m^2 + 2m^2 (\pm 10\%)$
 If $nhab = \{4,5\} \Rightarrow F1 \geq 16m^2 + 3m^2 (\pm 10\%)$
 If $nhab = 6 \Rightarrow F1 \geq 19.5m^2 + 3m^2 (\pm 10\%)$
 If $nhab = 7 \Rightarrow F1 \geq 22.5m^2 + 4m^2 (\pm 10\%)$
 If $nhab \geq 8 \Rightarrow F1 \geq 26m^2 + 4m^2 (\pm 10\%)$

Functions:
 $F1 \in \{li\}$
 $F2 \in \{li/mr\}$

Description (abbreviated):

$R3.9 < D3: F1; Z; E > \rightarrow$
 $< D3: F2; Z' - \{li\}, Z' + \{li/mr\}; E - \{li\}, E + \{li/mr\} >$

Rule 3.10 _ Changing from step 3 to step 7 if there is no spaces satisfying rules 3.1a to 3.5b

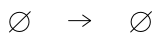

Conditions:

$If \forall F: F \leq \text{dimensions_of}(\text{Rule 3.1.a}) = \text{TRUE} \vee$
 $If \forall F: F \leq \text{dimensions_of}(\text{Rule 3.1.b}) = \text{TRUE} \vee$
 $If \forall F: F \leq \text{dimensions_of}(\text{Rule 3.2.a}) = \text{TRUE} \vee$
 $If \forall F: F \leq \text{dimensions_of}(\text{Rule 3.2.b}) = \text{TRUE} \vee$
 $If \forall F: F \leq \text{dimensions_of}(\text{Rule 3.3.a}) = \text{TRUE} \vee$
 $If \forall F: F \leq \text{dimensions_of}(\text{Rule 3.3.b}) = \text{TRUE} \vee$
 $If \forall F: F \leq \text{dimensions_of}(\text{Rule 3.4}) = \text{TRUE} \vee$
 $If \forall F: F \leq \text{dimensions_of}(\text{Rule 3.5.a}) = \text{TRUE} \vee$
 $If \forall F: F \leq \text{dimensions_of}(\text{Rule 3.5.b}) = \text{TRUE}$
 $\Rightarrow \text{Rule 7.1.a} \vee \text{Rule 7.1.b} \vee \text{Rule 7.1.g} \vee \text{Rule 7.4.a}$

Description (abbreviated):

$R3.10 < D3: S3 > \rightarrow < D7: S7 >$

Guest bathroom assignment

Rule 3.11 _ Assignment of guest bathrooms (recommended level)

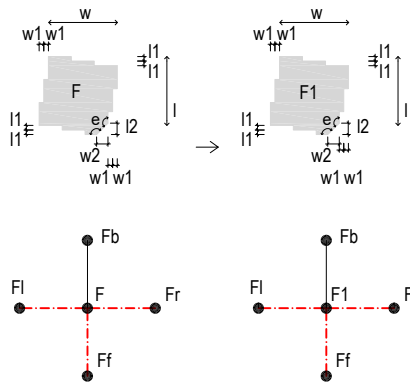

Conditions:

$$Z \supset \{ba.g\} \wedge Z \supset \{ba.g\}$$

Dimensions:

$$1m^2 \leq F \leq 3m^2$$

$$l, w \geq 1m$$

$$0m \leq l1, w1 \leq 1m$$

$$l2, w2 \geq 0m$$

$$e \in \{135^\circ, 180^\circ\}$$

Functions:

$$F \in \{nhs\} \wedge F(\text{inside}(x)) = \text{TRUE}, x \in \{uba\} \wedge$$

$$\exists l(\text{passage_to}(y)) \mid F(\text{passage_to}(y)) = \text{TRUE}, y \in \{Ff, Fb, Fl, Fr\} \wedge Fb \vee Ff \vee Fr \vee Fl \in \{nhs, co, co.s\}$$

$$\vee$$

$$F \in \{Xba\}$$

$$F(\text{next_to}(t)) = \text{TRUE}, t \in \{li, di, li/di, ki, mr\} \vee F(\text{close_to}(t)) = \text{TRUE}, t \in \{li, di, li/di, ki, mr\}$$

$$F1 \in \{ba.g\}$$

Description (abbreviated):

$$R3.11 < D3: Fb, Ff, Fr, Fl; F; Z; E > \rightarrow$$

$$< D3: Fb, Ff, Fr, Fl; ba.p2; Z' + \{ba.p2\}; E - \{nhs\}, E + \{ba.p2\} >$$

Rule 3.12 _ Create a guest bathroom (next to side wall)

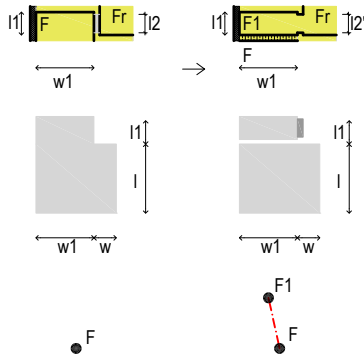

Conditions:

$$Z \supset \{ba.g\} \wedge Z \supset \{ba.g\}$$

Dimensions:

$$0m \leq w \leq 2m$$

$$3m \leq l \leq 4.5m$$

$$1.5m \leq w1 \leq 3.5m$$

$$0.9m \leq l1 \leq 1.5m$$

$$0m \leq l2 \leq 1.5m$$

$$l2' = 0.8m$$

Functions:

$$F \in \{be.d, be.t, be.s, di, li, li/di, ho, mr, ki, hs\}$$

$$Fr \in \{co, co.s, co.p, hl\}$$

$$F(\text{inside}(x)) = \text{TRUE}, x \in \{uba\}$$

$$F(\text{adjacent_to}(x)) = \text{TRUE}, x \in \{usi\}$$

$$Fr(\text{passage_to}(y)) = \text{TRUE} \vee Fr(\text{next_to}(y)) = \text{TRUE}, y \in \{li, di, li/di, mr\}$$

$$F1 \in \{ba.g\}$$

Description (abbreviated):

$$R3.12 < D3: F, Fr; Z; E > \rightarrow$$

$$< D3: F, ba.g, F1; Z' + \{ba.g\}; E + \{ba.g\} >$$

Rule 3.13 _ Create a guest bathroom (included in the hall)

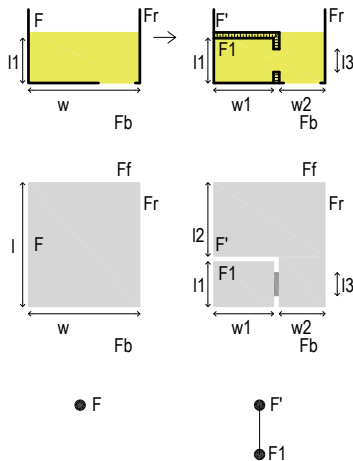

Conditions:

$$Z \supset \{ba.g\} \wedge Z \supset \{ba.g\}$$

Dimensions:

$$l, w \geq 2.4m$$

$$w2 \geq 1m$$

$$l2 \geq 1.2m$$

$$1m \leq l1, w1 \leq 1.5m$$

$$l3 \in \{0.8m, 0.9m\}$$

Function:

$$F, F' \in \{hl\}$$

$$F = F'$$

$$Fb \in \{nhs, co, co.s, co.p\}$$

$$Fr = lh \vee Ff = lh$$

$$F1(\text{inside}(x)) = \text{TRUE}, x \in \{uba\}$$

$$F1 \in \{ba.g\}$$

Description (abbreviated):

$$R3.13 < D3: F; Z; E > \rightarrow$$

$$< D3: F, \{ba.g\}; Z' + \{ba.g\}; E + \{ba.g\} >$$

Rule 3.14 _ Create a guest bathroom by dividing a space in two

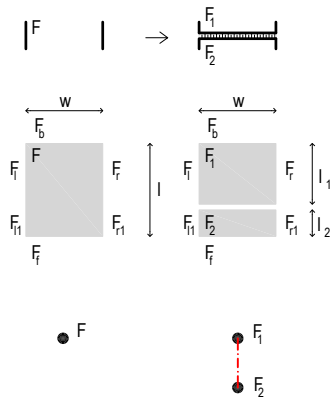

Conditions:

Dimensions:
 $w, l_1, l_2 \geq 1m$
 $l \geq 2.2m$

If *minimum_level* $\Rightarrow F \geq 5m^2 \wedge F_1 \geq 3.5m^2$

If *recommended_level* $\Rightarrow F \geq 7.5m^2 \wedge F_1 \geq 5m^2$
 $F_2 \geq 1m^2$

Functions:

$F, F_1 \in \{ba.p1, ba.p2\}$

$F_b \vee F_1 \vee F_2 \in \{co, co.s, co.p, nhs\}$

$F_b \vee F_1 \vee F_2 \in \{co, co.s, co.p, nhs, be.d\}$

$F_2 \in \{ba.g\}$

Description (abbreviated):

Rule 3.14 < D3: F; Z; E; $w * \emptyset$ > \rightarrow

< D3: F1, {ba.g}; Z + {ba.g}; E + {ba.g}; $w * ul$ >

Rule 3.15 _ Changing Xba label

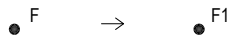

Conditions:

$Z \in \{ba.p1, ba.p2, ba.p3, ba.g\}$

Functions:

$F \in \{Xba\}$

$F_1 \in \{nhs\}$

Description (abbreviated):

R3.15 < D3: Xba; E > \rightarrow < D3: nhs; E - {Xba}, E + {nhs} >

Rule 3.16 _ Changing from step 3 to step 7 if there is no spaces satisfying rules 3.11 to 3.14

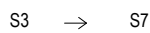
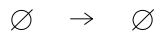

Conditions:

$\forall F: F = \text{conditions_of}(\text{Rules } 3.11, 3.12, 3.13, 3.14) = \text{FALSE}$

Description (abbreviated):

R3.16 < D3: S3 > \rightarrow < D7: S7 >

Rule 3.17 _ Changing from step 3 to step 4

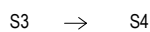
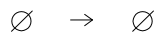

Conditions:

If $Z \supset \{li\} \wedge Z \supset \{li\} \wedge E \supset \{li\}$

If $Z \supset \{di\} \wedge Z \supset \{di\} \wedge E \supset \{di\}$

If $Z \supset \{ho\} \wedge Z \supset \{ho\} \wedge E \supset \{ho\}$

If $Z \supset \{mr\} \wedge Z \supset \{mr\} \wedge E \supset \{mr\}$

If $Z \supset \{ba.g\} \wedge Z \supset \{ba.g\} \wedge E \supset \{ba.g\}$

Description (abbreviated):

R3.17 < D3: S3 > \rightarrow < D4: S4 >

Rule 4.1 _ Assignment of private corridors

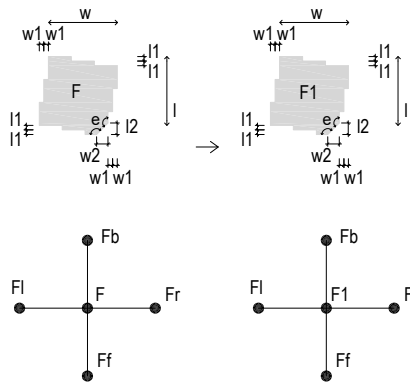

Conditions:

Dimensions:
 $0.9m \leq l, w \leq 10m$
 $1m^2 \leq F \leq 15m^2$
 $0m \leq l1$
 $w1 \leq 1m$
 $l2, w2 \geq 0m$
 $e \in \{135^\circ, 180^\circ\}$

Function:

$F \in \{nhs\}$
 $\forall x: F(\text{passage_to}(x)) = \text{TRUE}, x \in \{Fb, Ff, Fr, Fl\}$
 $\wedge x \in \{be.d, be.t, be.s, cl, ba.p, ho, hl, co, co.s, st, nhs\}$
 $\wedge \exists x \in \{be.d, be.t, be.s, ba.p\}$
 \vee
 $F(\text{passage_to}(x)) = \text{TRUE}, x \in \{Fb, Ff, Fr, Fl\}$
 $\wedge x \in \{be.d, be.t, be.s, cl, ba.p, ho, hl, co, co.s, st, nhs, li, di, li/di\}$
 $\wedge \exists x \in \{be.d, be.t, be.s, ba.p\}$
 $\wedge \text{if } x \in \{li, di, li/di\} \Rightarrow x(\text{passage_to}(y)) \geq 2, y \in \{nhs, co, co.s, co.p\}$
 $F1 \in \{co.p\}$

Description (abbreviated):

R4.1 < D4: Fb, Ff, Fr, Fl; F; Z; E > →
 < D4:Fb, Ff, Fr, Fl; co.p; Z' + {co.p}; E - {nhs}, E + {co.p}>

Rule 4.2 _ Assignment of social corridors

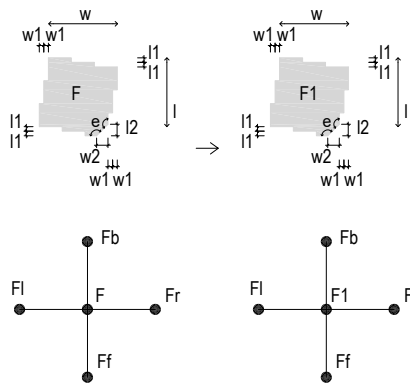

Conditions:

Dimensions:
 $0.9m \leq l, w \leq 10m$
 $1m^2 \leq F \leq 15m^2$
 $0m \leq l1$
 $w1 \leq 1m$
 $l2, w2 \geq 0m$
 $e \in \{135^\circ, 180^\circ\}$

Function:

$F \in \{nhs\}$
 $\forall x: F(\text{passage_to}(x)) = \text{TRUE}, x \in \{Fb, Fr, Ff, Fl\} \wedge$
 $(x \in \{li, di, li/di, ho, mr, ba.g, hl, co.p, cl, st, nhs\} \vee$
 $\exists x \in \{ki, la, st\} \wedge \exists x \in \{li, di, li/di, ho, mr, ba.g, hl, co.p, cl, st, nhs\} \vee$
 $\exists x \in \{be.d, be.t, be.s, ba.p, cl\} \wedge$
 $\exists x \in \{li, di, li/di, ho, mr, ba.g, hl, co.p, cl, st, nhs\})$
 $F1 \in \{co\}$

Description (abbreviated):

R4.2 < D4: Fb, Ff, Fr, Fl; F; Z; E > →
 < D4:Fb, Ff, Fr, Fl; co; Z' + {co}; E - {nhs}, E + {co}>

Rule 4.3 _ Assignment of service corridors

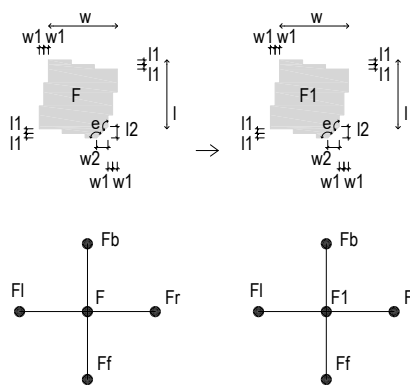

Conditions:

Dimensions:
 $0.9m \leq l, w \leq 10m$
 $1m^2 \leq F \leq 15m^2$
 $0m \leq l1$
 $w1 \leq 1m$
 $l2, w2 \geq 0m$
 $e \in \{135^\circ, 180^\circ\}$

Function:

$F \in \{nhs\}$
 $\forall x: F(\text{passage_to}(x)) = \text{TRUE}, x \in \{Fb, Ff, Fr, Fl\} \wedge x \in \{ki, la, cl, st, hl, co, co.s, nhs\}$
 $F1 \in \{co.s\}$

Description (abbreviated):

R4.3 < D4: Fb, Ff, Fr, Fl; F; Z; E > →
 < D4:Fb, Ff, Fr, Fl; co.s; Z' + {co.s}; E - {nhs}, E + {co.s}>

Circulation assignment + laundry assignment

Rule 4.4 _ Changing from step 4 to step 7 if there is assigned rooms with no connections

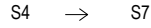
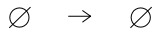

Conditions:

$If Z \supset \{be.d\} \wedge be.d (passage_to(y)) = FALSE, y \in \{co, co.p, hl, cl\}$
 $If Z \supset \{be.t\} \wedge be.t (passage_to(y)) = FALSE, y \in \{co, co.p, hl, cl\}$
 $If Z \supset \{be.s\} \wedge be.s (passage_to(y)) = FALSE, y \in \{co, co.p, hl, cl\}$
 $If Z \supset \{ba.p\} \wedge ba.p (passage_to(y)) = FALSE, y \in \{co, co.p, cl, be.d, be.t, be.s\}$
 $If Z \supset \{li\} \wedge li (passage_to(y)) = FALSE, y \in \{co, hl\}$
 $If Z \supset \{di\} \wedge di (passage_to(y)) = FALSE, y \in \{co, hl, li, ki\}$
 $If Z \supset \{ho\} \wedge ho (passage_to(y)) = FALSE, y \in \{co, co.p, co.s, hl, cl, li, di\}$
 $If Z \supset \{mr\} \wedge mr (passage_to(y)) = FALSE, y \in \{co, co.p, co.s, hl, li, di, ho\}$
 $If Z \supset \{ba.g\} \wedge ba.g (passage_to(y)) = FALSE, y \in \{co, hl\}$
 $\Rightarrow Rules 7.3 \vee Rules 7.5 \vee Rules 7.6$

Description (abbreviated):

R4.4 < D4: S4 > \rightarrow < D7: S7 >

Rule 4.5 _ Changing from step 4 to step 5

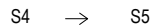
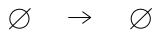

Conditions:

$\forall be.d: be.d (passage_to(y)) = TRUE, y \in \{co, co.p, hl, cl\}$
 $\forall be.t: be.t (passage_to(y)) = TRUE, y \in \{co, co.p, hl, cl\}$
 $\forall be.s: be.s (passage_to(y)) = TRUE, y \in \{co, co.p, hl, cl\}$
 $\forall ba.p: ba.p (passage_to(y)) = TRUE, y \in \{co, co.p, cl, be.d, be.t, be.s\}$
 $\forall li: li (passage_to(y)) = TRUE, y \in \{co, hl\}$
 $\forall di: di (passage_to(y)) = TRUE, y \in \{co, hl, li, ki\}$
 $\forall ho: ho (passage_to(y)) = TRUE, y \in \{co, co.p, co.s, hl, cl, li, di\}$
 $\forall mr: mr (passage_to(y)) = TRUE, y \in \{co, co.p, co.s, hl, li, di, ho\}$
 $\forall ba.g: ba.g (passage_to(y)) = TRUE, y \in \{co, hl\}$

Description (abbreviated):

R4.5 < D4: S4 > \rightarrow < D5: S5 >

Rule 5.1 _ Assignment of isolated laundry (strategy 2)

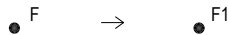

Conditions:

$Z \supset \{la\} \wedge Z \not\supset \{la\}$

Functions:

$If \{strategy2\} \wedge F \in \{Xla\} \Rightarrow F1 \in \{la\}$

Description (abbreviated):

R5.1 < D5: Xla; Z; E > \rightarrow
 < D5: la; Z + {la}; E - {Xla}, E + {la} >

Rule 5.2.a _ Assignment of included laundry (minimum level) (strategy1)

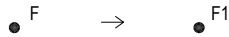

Conditions:

Dimensions:
 $F \geq 8m^2 (\pm 10\%)$
 $l, w \geq 1,7m$

Functions:
 $F \in \{ki\}$
 $F1 \in \{ki/la\}$

Description (abbreviated):

$R5.2a < D5: ki; Z'; E > \rightarrow$
 $< D5: ki/la; Z' - \{ki\}, Z' + \{ki/la\}; E - \{ki\}, E + \{ki/la\} >$

Rule 5.2.b _ Assignment of included laundry (recommended level) (strategy1)

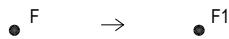

Conditions:

Dimensions:
 If $nhab=4 \Rightarrow F \geq 14m^2 (\pm 10\%)$
 If $7 > nhab \geq 5 \Rightarrow F \geq 15m^2 + 0,5m^2(n-5) (\pm 10\%)$
 If $nhab \geq 7 \Rightarrow F \geq 16m^2 + 0,5m^2(n-5) (\pm 10\%)$
 $l, w \geq 1,7m$

Functions:
 $F \in \{ki\}$
 $F1 \in \{ki/la\}$

Description (abbreviated):

$R5.2b < D5: ki; Z'; E > \rightarrow$
 $< D5: ki/la; Z' - \{ki\}, Z' + \{ki/la\}; E - \{ki\}, E + \{ki/la\} >$

Rule 5.3 _ Changing Xba label (strategy1)

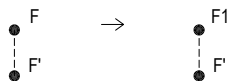

Conditions:

$Z \supset \{la\}$

Functions:
 $F \in \{Xla\}$
 $F' \in \{be.s, be.t, be.d\}$
 $F1 \in \{cl\}$

Description (abbreviated):

$R5.3 < D5: Xla; E > \rightarrow < D5: cl; E - \{Xla\}, E + \{cl\} >$

Rule 5.4 _ Changing from step 5 to step 6

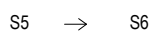
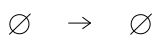

Conditions:

$Z \supset \{la\} \wedge Z' \supset \{la\} \wedge E \supset \{la\}$

Description (abbreviated):

$R5.4 < D5: S5 > \rightarrow < D6: S6 >$

Rule 6.1: Assignment of cloth storage

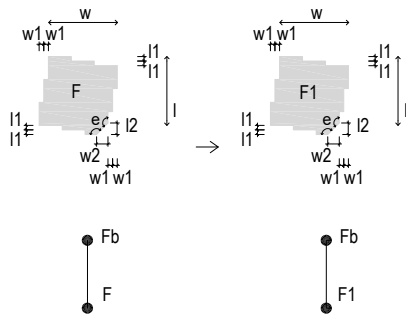

Conditions:

Dimensions:
 $0.5m^2 < F \leq 6m^2$
 $0.6m \leq l, w \leq 3m$
 $0m \leq l_1$
 $w_1 \leq 1m$
 $l_2, w_2 \geq 0m$
 $e \in \{135^\circ, 180^\circ\}$

Functions:

$F \in \{nhs\}$
 $Fb \in \{co.p, be.d, be.t, be.s, ba.p\}$
 $\exists l F (passage_to(y)) = TRUE, y \in \{Fb\}$
 $F1 \in \{cl\}$

Description (abbreviated):

$R6.1 < D6: Fb, F, Z; E > \rightarrow$
 $< D6: Fb, cl; Z' + \{cl\}; E - \{nhs\}, E + \{cl\} >$

Rule 6.2: Assignment of general storage

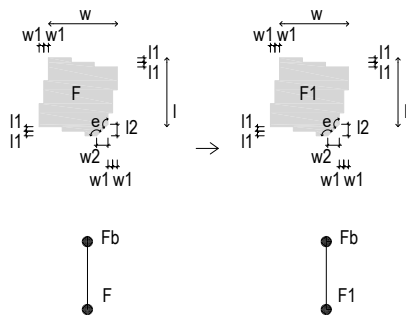

Conditions:

Dimensions:
 $0.5m^2 < F \leq 6m^2$
 $0.6m \leq l, w \leq 3m$
 $0m \leq l_1$
 $w_1 \leq 1m$
 $l_2, w_2 \geq 0m$
 $e \in \{135^\circ, 180^\circ\}$

Functions:

$F \in \{nhs\}$
 $Fb \in \{co, co.s, hl, ki, la, ho, mr\}$
 $\exists l F (passage_to(y)) = TRUE, y \in \{Fb\}$
 $F1 \in \{st\}$

Description (abbreviated):

$R6.2 < D6: Fb, F, Z; E > \rightarrow$
 $< D6: Fb, st; Z' + \{st\}; E - \{nhs\}, E + \{st\} >$

Rule 6.3: Creation of new general or clothes storage

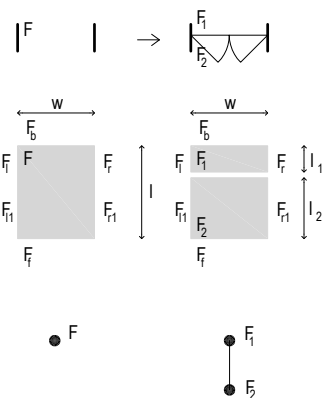

Conditions:

Dimensions:
 $0.5m^2 < F \leq 6m^2$
 $w, l_2 \geq 1m$
 $l \geq 1.6m$
 $l_1 \geq 0.6m$

Functions:

$Fb, F1, F1, Fr, F11, F1 \in \{Z\}$
 $// F \in \{co, co.s\} \wedge F (passage_to(y)) = FALSE, y \in \{Fb, F1, Fr\} \Rightarrow F1 \in \{st\}$
 $// F \in \{co.p\} \wedge F (passage_to(y)) = FALSE, y \in \{Fb, F1, Fr\} \Rightarrow F1 \in \{cl\}$

Description (abbreviated):

$R6.3 < D6: Fb, Ff, Fr, F1, F11; F; Z; E > \rightarrow$
 $< D6: Fb, Ff, Fr, F1, F11; \{st, cl\}; Z' + \{st, cl\}; E + \{st, cl\} >$

Rule 6.4: Assignment of general or clothes storage

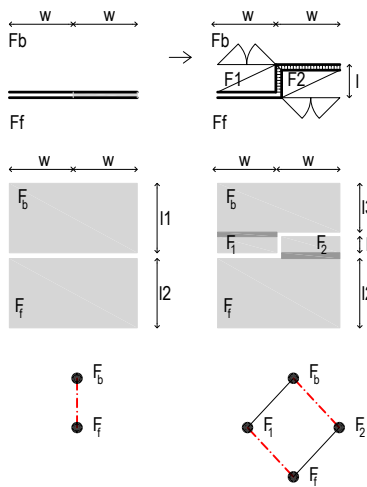

Conditions:

Dimensions:

- If $Ff \in \{be.d\} \Rightarrow l2 \geq 2.7m$
- If $Fb \in \{be.d\} \Rightarrow l1 \geq 3.45m \wedge l3 \geq 2.7m$
- If $Ff \in \{be.t, be.s, ho, mr\} \Rightarrow l2 \geq 2.1m$
- If $Fb \in \{be.t, be.s, ho, mr\} \Rightarrow l1 \geq 2.85m \wedge l3 \geq 2.1m$
- If $Ff \in \{nhs, co, co.p, co.s, hl\} \Rightarrow l2 \geq 1m$
- If $Fb \in \{nhs, co, co.p, co.s, hl\} \Rightarrow l1 \geq 1.75m \wedge l3 \geq 1m$
- $w \geq 1m$
- $l = 0,75m$

Functions:

- $Fb, Ff \in \{nhs, co, co.s, co.p, be.d, be.t, be.s, ho, mr\}$
- If $Ff \in \{be.d, be.t, be.s\} \Rightarrow F2 = cl$
- If $Ff \in \{ho, mr, nhs, co, co.p, co.s, hl\} \Rightarrow F2 \in \{st\}$
- If $Fb \in \{be.d, be.t, be.s\} \Rightarrow F1 = cl$
- If $Fb \in \{ho, mr, nhs, co, co.p, co.s, hl\} \Rightarrow F1 \in \{st\}$

Description (abbreviated):

- $R6.4 < D6: Fb, Ff, Z: E > \rightarrow$
- $< D6: Fb, Ff; \{cl, st\}; Z' + \{cl, st\}; E + \{cl, st\} >$

Rule 6.5 _ Changing from step 6 to step 7

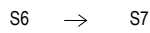
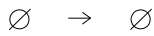

Conditions:

- $Z \supset \{cl\} \wedge Z' \supset \{cl\} \wedge E \supset \{cl\}$
- $Z \supset \{st\} \wedge Z' \supset \{st\} \wedge E \supset \{st\}$

Description (abbreviated):

- $R6.5 < D6: S6 > \rightarrow < D7: S7 >$

Rule 7.1.a _ Connecting three adjacent rooms (by eliminating an L-shaped wall)

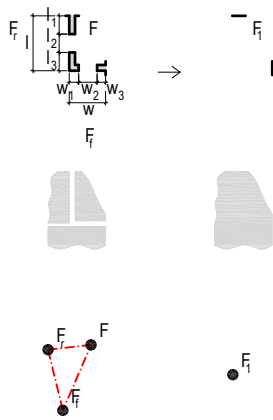

Conditions:

Dimensions:
 $0.9m \leq l \leq 2m \wedge 0m \leq l1, l2, l3 \leq 2m$
 $0.9m \leq w \leq 2m \wedge 0m \leq w1, w2, w3 \leq 2m$

Function:

$F \in \{nhs, Xba, Xla, cl, st\}$
 $F_r \in \{nhs, co, co.p, co.s, cl\}$
 $F_f \in \{hs, be.d, be.t, be.s, ki, li, di, li/di, ho, mr\}$
 $F_f = F1$

Description (abbreviated):

$R7.1a < D7: Fr, F1, F; w^*wub(F, F1), l^*wub(F, Fr) > \rightarrow$
 $< D7: F1; w^*\emptyset >$

Rule 7.1.b _ Connecting two adjacent rooms (by eliminating a straight wall)

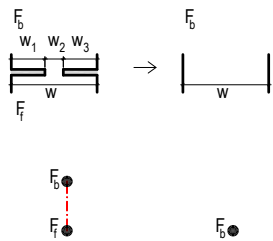

Conditions:

Dimensions:
 $w \leq 2m$
 $0m \leq w1, w2, w3 \leq 2m$

Function:

$F_b \in \{be.d, be.t, be.s\} \wedge F_f \in \{nhs, co, co.p, co.s, cl\}$
 \vee
 $F_b \in \{li, di, li/di, ho, mr\} \wedge F_f \notin \{be.d, be.t, be.s, ba.p, ba.g, la, ki\}$
 \vee
 $F_b \in \{la\} \wedge F_f \in \{Xba, nhs, st\}$
 \vee
 $F_b, F_f \in \{co, co.s, co.p\} \wedge F_b = F_f$

Description (abbreviated):

$R7.1.b < D7: Fb, Ff; w^*wub(Fb, Ff) > \rightarrow < D7: Fb; w^*\emptyset >$

Rule 7.1.c _ Connecting two adjacent rooms (by eliminating a straight wall)

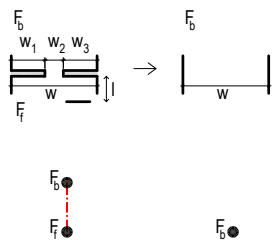

Conditions:

Dimensions:
 $2m \leq w \leq 3m$
 $0m \leq w1, w2, w3 \leq 3m$
 $l \leq 1.5m$

Function:

$F_b \in \{be.d, be.t, be.s\} \wedge F_f \in \{nhs, Xba.se, co, co.p, co.s, cl\}$
 \vee
 $F_b \in \{li, di, li/di, ho, mr\} \wedge F_f \notin \{be.d, be.t, be.s, ba.p, ba.g, la, ki\}$
 \vee
 $F_b \in \{la\} \wedge F_f \in \{Xba.se, nhs, st\}$

Description (abbreviated):

$R7.1.c < D7: Fb, Ff; w^*wub(Fb, Ff) > \rightarrow < D7: Fb; w^*\emptyset >$

Rule 7.1.d _ Connecting two adjacent rooms (by eliminating a wall)

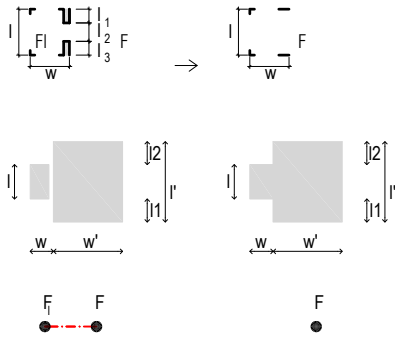

Conditions:

Dimensions:
 $1m \leq w \leq 3m$
 $0m \leq l_1, l_2 \leq 3m$
 $1m \leq l \leq 2m$
 $1m \leq w', l' \leq 4m$

Function:

$F \in \{ki\} \wedge F \in \{nhs, Xba, st\} \wedge \exists F_l (passage_to(x))=TRUE, x \in \{nhs, Xba, st\}$
 \vee
 $F \in \{li, di, li/di, ho, mr\} \wedge F \in \{co, co.s\} \wedge \exists F_l (passage_to(x))=TRUE, x \in \{co, co.s\}$

Description (abbreviated):

$R7.1.d < D7: F_l, F; l^*wub(F_l, F) > \rightarrow < D7: F; l^*\emptyset >$

Rule 7.1.e _ Connecting two adjacent spaces (by eliminating a straight wall)

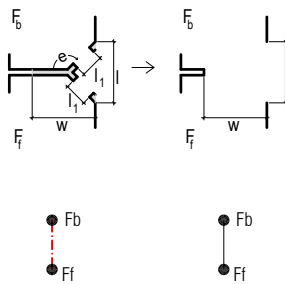

Conditions:

Dimensions:
 $w, l \leq 2m$
 $0m \leq l_1 \leq 2m$
 $e=135^\circ$

Function:

$Fb \in \{li, di, li/di, ho, mr\}$
 $Ff \notin \{be.d, be.t, be.s, ba.p, ba.g, la, ki\}$

Description:

$R7.1.e < D7: F_b, F_f; w^*ub, l^*ub > \rightarrow < D7: F_b; \emptyset, \emptyset >$

Rule 7.1.f _ Connecting two adjacent rooms (by eliminating part of a straight wall, in the middle of the wall)

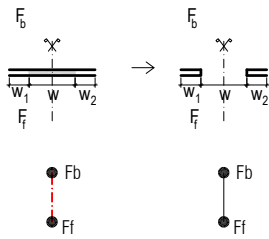

Conditions:

Dimensions:

$$w1 + w + w2 \geq 1m$$

$$w \in \{0.8m, 0.9m, 1m, 1.2m, 1.6m\}$$

$$w1, w2 \geq 0m$$

Function:

Private areas

$$Fb \in \{be.d, be.t, be.s\} \wedge Ff \in \{nhs, co.p, co\} \wedge Fb(\text{passage_to}(x)=FALSE, \forall x \in \{nhs, co.p, co\}) \Rightarrow w \in \{0.8m, 0.9m, 1m\}$$

$$Fb \in \{be.d, be.t, be.s\} \wedge Ff \in \{cl, ba.p\} \wedge Ff(\text{passage_to}(x)=FALSE, \forall x \in \{Z, hs, nhs\}) \Rightarrow w \in \{0.8m, 0.9m, 1m\}$$

$$Fb \in \{ba.p, cl\} \wedge Ff \in \{nhs, co.p, co\} \wedge Fb(\text{passage_to}(x)=FALSE, \forall x \in \{Z, hs, nhs\}) \Rightarrow w \in \{0.8m, 0.9m, 1m\}$$

Living areas

$$Fb \in \{li, di, li/di, ho, mr\} \wedge Ff \in \{nhs, co, co.s, hl\} \wedge Fb(\text{passage_to}(x)=FALSE, \forall x \in \{nhs, co, hl\})$$

$$Fb \in \{li\} \wedge Ff \in \{di, ho, mr\}$$

$$Fb \in \{di, li/di\} \wedge Ff \in \{li, ho, mr, ki\}$$

$$Fb \in \{ho\} \wedge Ff \in \{li, di, li/di, mr, co.p, ki, cl, st, be.d\}$$

$$Fb \in \{mr\} \wedge Ff \in \{li, di, li/di, ho\}$$

Service areas

$$Fb \in \{ki\} \wedge Ff \in \{co, co.s, hl\} \wedge Fb(\text{passage_to}(x)=FALSE, \forall x \in \{co, co.s, hl\}) \Rightarrow w \in \{0.8m, 0.9m, 1m\}$$

$$Fb \in \{ki\} \wedge Ff \in \{di, li/di, la\} \wedge Fb(\text{passage_to}(x)=FALSE, \forall x \in \{di, li/di, la\})$$

Circulations areas

$$Ff, Fb \in \{nhs, co, co.p, co.s, hl\}$$

Storage areas

$$Fb \in \{cl\} \wedge Ff \in \{co, co.p, be.d, be.t, be.s\} \wedge Fb(\text{passage_to}(x)=FALSE, \forall x \in \{co, co.p, be.d, be.t, be.s\}) \Rightarrow w \in \{0.8m, 0.9m, 1m\}$$

$$Fb \in \{st\} \wedge Ff \in \{co, co.s, hl, ki, la, ho, mr\} \wedge Fb(\text{passage_to}(x)=FALSE, \forall x \in \{co, co.s, hl, ki, la, ho, mr\}) \Rightarrow w \in \{0.8m, 0.9m, 1m\}$$

Rule 7.1.g _ Connecting two adjacent rooms (by eliminating part of a straight wall, next to the perpendicular partition wall)

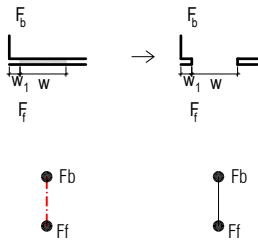

Conditions:

Dimensions:

$w \in \{0.8m, 0.9m, 1m, 1.2m, 1.6m\}$

$w1 = 0,1m$

Function:

Private areas

$Fb \in \{be.d, be.t, be.s\} \wedge Ff \in \{nhs, co.p, co\} \wedge Fb(\text{passage_to}(x)=FALSE, \forall x \in \{nhs, co.p, co\}) \Rightarrow w \in \{0.8m, 0.9m, 1m\}$

$Fb \in \{be.d, be.t, be.s\} \wedge Ff \in \{cl, ba.p\} \wedge Ff(\text{passage_to}(x)=FALSE, \forall x \in \{Z, hs, nhs\}) \Rightarrow w \in \{0.8m, 0.9m, 1m\}$

$Fb \in \{ba.p, cl\} \wedge Ff \in \{nhs, co.p, co\} \wedge Fb(\text{passage_to}(x)=FALSE, \forall x \in \{Z, hs, nhs\}) \Rightarrow w \in \{0.8m, 0.9m, 1m\}$

Living areas

$Fb \in \{li, di, li/di, ho, mr\} \wedge Ff \in \{nhs, co, co.s, hl\} \wedge Fb(\text{passage_to}(x)=FALSE, \forall x \in \{nhs, co, hl\})$

$Fb \in \{li\} \wedge Ff \in \{di, ho, mr\}$

$Fb \in \{di, li/di\} \wedge Ff \in \{li, ho, mr, ki\}$

$Fb \in \{ho\} \wedge Ff \in \{li, di, li/di, mr, co.p, ki, cl, st, be.d\}$

$Fb \in \{mr\} \wedge Ff \in \{li, di, li/di, ho\}$

Service areas

$Fb \in \{ki\} \wedge Ff \in \{co, co.s, hl\} \wedge Fb(\text{passage_to}(x)=FALSE, \forall x \in \{co, co.s, hl\}) \Rightarrow w \in \{0.8m, 0.9m, 1m\}$

$Fb \in \{ki\} \wedge Ff \in \{di, li/di, la\} \wedge Fb(\text{passage_to}(x)=FALSE, \forall x \in \{di, li/di, la\})$

Circulations areas

$Ff, Fb \in \{nhs, co, co.p, co.s, hl\}$

Storage areas

$Fb \in \{cl\} \wedge Ff \in \{co, co.p, be.d, be.t, be.s\} \wedge Fb(\text{passage_to}(x)=FALSE, \forall x \in \{co, co.p, be.d, be.t, be.s\}) \Rightarrow w \in \{0.8m, 0.9m, 1m\}$

$Fb \in \{st\} \wedge Ff \in \{co, co.s, hl, ki, la, ho, mr\} \wedge Fb(\text{passage_to}(x)=FALSE, \forall x \in \{co, co.s, hl, ki, la, ho, mr\}) \Rightarrow w \in \{0.8m, 0.9m, 1m\}$

Description (abbreviated):

$R7.1g < D7: Fb, Ff; w * wub(Fb, Ff) > \rightarrow$
 $< D7: Fb, Ff; w * \emptyset >$

Rule 7.1.h _ Connecting two adjacent rooms (by eliminating part of a straight wall, disting 0,7m to the perpendicular partition wall)

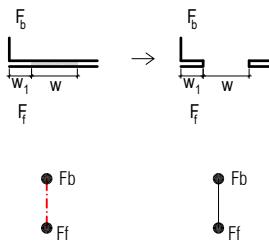

Conditions:

Dimensions:
 $w \in \{0.8m, 0.9m, 1m, 1.2m, 1.6m\}$
 $w_1 = 0.7m$

Function:

Private areas

$F_b \in \{be.d, be.t, be.s\} \wedge F_f \in \{nhs, co.p, co\} \wedge F_b(\text{passage_to}(x)=FALSE, \forall x \in \{nhs, co.p, co\}) \Rightarrow w \in \{0.8m, 0.9m, 1m\}$
 $F_b \in \{be.d, be.t, be.s\} \wedge F_f \in \{cl, ba.p\} \wedge F_f(\text{passage_to}(x)=FALSE, \forall x \in \{Z, hs, nhs\}) \Rightarrow w \in \{0.8m, 0.9m, 1m\}$
 $F_b \in \{ba.p, cl\} \wedge F_f \in \{nhs, co.p, co\} \wedge F_b(\text{passage_to}(x)=FALSE, \forall x \in \{Z, hs, nhs\}) \Rightarrow w \in \{0.8m, 0.9m, 1m\}$

Living areas

$F_b \in \{li, di, li/di, ho, mr\} \wedge F_f \in \{nhs, co, co.s, hl\} \wedge F_b(\text{passage_to}(x)=FALSE, \forall x \in \{nhs, co, hl\})$
 $F_b \in \{li\} \wedge F_f \in \{di, ho, mr\}$
 $F_b \in \{di, li/di\} \wedge F_f \in \{li, ho, mr, ki\}$
 $F_b \in \{ho\} \wedge F_f \in \{li, di, li/di, mr, co.p, ki, cl, st, be.d\}$
 $F_b \in \{mr\} \wedge F_f \in \{li, di, li/di, ho\}$

Service areas

$F_b \in \{ki\} \wedge F_f \in \{co, co.s, hl\} \wedge F_b(\text{passage_to}(x)=FALSE, \forall x \in \{co, co.s, hl\}) \Rightarrow w \in \{0.8m, 0.9m, 1m\}$
 $F_b \in \{ki\} \wedge F_f \in \{di, li/di, la\} \wedge F_b(\text{passage_to}(x)=FALSE, \forall x \in \{di, li/di, la\})$

Circulations areas

$F_f, F_b \in \{nhs, co, co.p, co.s, hl\}$

Storage areas

$F_b \in \{cl\} \wedge F_f \in \{co, co.p, be.d, be.t, be.s\} \wedge F_b(\text{passage_to}(x)=FALSE, \forall x \in \{co, co.p, be.d, be.t, be.s\}) \Rightarrow w \in \{0.8m, 0.9m, 1m\}$
 $F_b \in \{st\} \wedge F_f \in \{co, co.s, hl, ki, la, ho, mr\} \wedge F_b(\text{passage_to}(x)=FALSE, \forall x \in \{co, co.s, hl, ki, la, ho, mr\}) \Rightarrow w \in \{0.8m, 0.9m, 1m\}$

Description (abbreviated):

R7.1.h < D7: Fb, Ff; w*wub(Fb, Ff) > →
 < D7: Fb, Ff; w*∅ >

Rule 7.1.i _ Widening the connection between two rooms (by partially eliminating walls on both sides of a door opening)

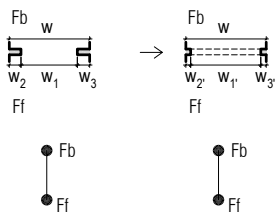

Conditions:

Dimensions:
 $w_1 \geq 1/2 w$
 $w_1 \geq 0.9m$
 $w_2', w_3' \geq 0m$
 $w_1' \in \{1m, 1.2m, 1.6m, 2m, 2.2m, 2.5m, w\}$

Function:
 $F_b, F_f \in \{Z\}$

Description (abbreviated):

R7.1i < D7: Fb, Ff; w2*wub(Fb, Ff), w3*wub(Fb, Ff) > →
 < D7: Fb, Ff; w2*wub(Fb, Ff), w3*wub(Fb, Ff) >

Rule 7.1.j _ Widening the connection between two rooms (by partially eliminating walls on both sides of a door opening)

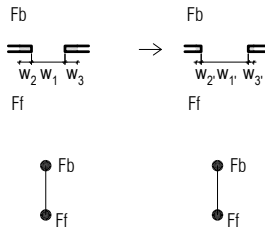

Conditions:

Dimensions:
 $1m \leq w1 \leq 2m$
 $w1 \in \{1,0m, 1,2m, 1,6m\}$

Function:
 $Fb, Ff \in \{Z\}$

Description (abbreviated):

$R7.1j < D7: Fb, Ff; w2^*wub(Fb, Ff), w3^*wub(Fb, Ff) > \rightarrow$
 $< D7: Fb, Ff; w2^*wub(Fb, Ff), w3^*wub(Fb, Ff) >$

Rule 7.1.k _ Connecting two adjacent spaces (by eliminating part of a straight wall)

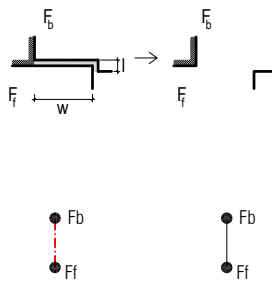

Conditions:

Dimensions:
 $w \leq 2m$
 $0,4m \leq l \leq 1m$

Function:
 $Fb, Ff \in \{li, di, li/di, ho, mr\}$
 \vee
 $Fb \in \{be.d, be.t, be.s\} \wedge Ff \in \{cl, ho, ba.p\}$

Description:

$R7.1k < D7: Fb, Ff; w^*ub, l^*ub > \rightarrow$
 $< D7: Fb, Ff; w^*\emptyset, l^*\emptyset, >$

Rule 7.1.l _ Connecting two adjacent spaces (by eliminating part of a straight wall)

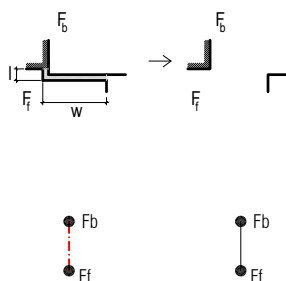

Conditions:

Dimensions:
 $w \leq 2m$
 $0,4m \leq l \leq 1m$

Function:
 $Fb, Ff \in \{li, di, li/di, ho, mr\}$
 \vee
 $Fb \in \{be.d, be.t, be.s\} \wedge Ff \in \{cl, ho, ba.p\}$

Description:

$R7.1l < D7: Fb, Ff; w^*ub, l^*ub > \rightarrow$
 $< D7: Fb, Ff; w^*\emptyset, l^*\emptyset, >$

Rule 7.2.a _ Separating rooms, closing door opening with light partition wall

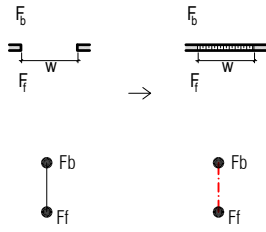

Conditions:

Function:
Fb ≠ Ff

Private areas

If (passage_to(Fb)) ≥ 2 ∧ Fb ∈ {be.d, be.t, be.s} ∧ Ff ∈ {ba.p, cl}

If (passage_to(Fb)) = 1 ∧ Fb ∈ {be.d, be.t, be.s} ∧ Ff ∈ {ba.p, cl, co.p, co}

Living areas

If (passage_to(Fb)) ≥ 2 ∧ Fb ∈ {li} ∧ Ff ∈ {di, ho, mr}

If (passage_to(Fb)) = 1 ∧ Fb ∈ {li} ∧ Ff ∈ {di, ho, mr, co, hl}

If (passage_to(Fb)) ≥ 2 ∧ Fb ∈ {di, li/di} ∧ Ff ∈ {li, ho, mr, ki}

If (passage_to(Fb)) = 1 ∧ Fb ∈ {di, li/di} ∧ Ff ∈ {li, ho, mr, ki, co, hl}

If (passage_to(Fb)) ≥ 2 ∧ Fb ∈ {ho} ∧ Ff ∈ {li, di, li/di, mr, co.p, ki, cl, st, be.d}

If (passage_to(Fb)) = 1 ∧ Fb ∈ {ho} ∧ Ff ∈ {li, di, li/di, mr, co.p, ki, cl, st, be.d, co, hll}

If (passage_to(Fb)) ≥ 2 ∧ Fb ∈ {mr} ∧ Ff ∈ {li, di, li/di, ho}

If (passage_to(Fb)) = 1 ∧ Fb ∈ {mr} ∧ Ff ∈ {li, di, li/di, ho, co, hl}

Service areas

If (passage_to(Fb)) ≥ 2 ∧ Fb ∈ {ki} ∧ Ff ∈ {la, di, li/di, st}

If (passage_to(Fb)) = 1 ∧ Fb ∈ {ki} ∧ Ff ∈ {la, di, li/di, st, co.s, co}

Storage areas

Fb ∈ {cl} ∧ Ff ∈ {be.d, be.t, be.s, co.p, co}

Fb ∈ {st} ∧ Ff ∈ {co, co.s, ki, la, ho, mr}

Description (abbreviated):

R7.2a < D7: Fb, Ff; w*∅ > → < D7: Fb, Ff; w*wu/(Fb, Ff) >

Rule 7.2.b _ Dividing a room in two by adding a wall

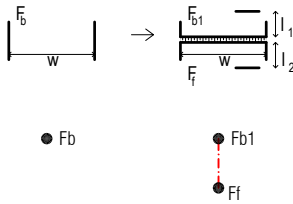

Conditions:

7.2.b1 Dividing a bedroom

Dimensions:

If *mimimum_level* \wedge $Fb \in \{be.d\} \Rightarrow Fb1 \geq 10,5m^2 \wedge w, l1 \geq 2,7m$ If *recommended_level* \wedge $Fb \in \{be.d\} \Rightarrow Fb1 \geq 12m^2 \wedge w, l1 \geq 2,7m$ If *mimimum_level* \wedge $Fb \in \{be.t\} \Rightarrow Fb1 \geq 9m^2 \wedge w, l1 \geq 2,1m$ If *recommended_level* \wedge $Fb \in \{be.t\} \Rightarrow Fb1 \geq 14,5m^2 \wedge w, l1 \geq 2,1m$ If *mimimum_level* \wedge $Fb \in \{be.s\} \Rightarrow Fb1 \geq 7m^2 \wedge w, l1 \geq 2,1m$ If *recommended_level* \wedge $Fb \in \{be.s\} \Rightarrow Fb1 \geq 8,5m^2 \wedge w, l1 \geq 2,1m$ $Ff \geq 1m^2 \wedge l2 \geq 1m$

Function:

 $Fb, Fb1 \in \{be.d, be.t, be.s\}$ $Ff \in \{nhs\}$ $Fb \neq Ff$

7.2.b2 Dividing a private bathroom

Dimensions:

 $w, l1, l2 \geq 1m$ If *mimimum_level* $\Rightarrow Fb \geq 5m^2 \wedge Fb1 \geq 3,5m^2$ If *recommended_level* $\Rightarrow Fb \geq 7,5m^2 \wedge Fb1 \geq 5m^2$ $Ff \geq 1m^2$

Functions:

 $Fb, Fb1 \in \{ba.p\}$ $Ff \in \{ba.p, ba.g, cl, nhs\}$

7.2.b3 Dividing social rooms

Dimensions:

 $Fb \in \{li\} \Rightarrow Fb1, lb \geq \text{dimensions_ofRule3.1a}$ $Fb \in \{di\} \Rightarrow Fb1, lb \geq \text{dimensions_ofRule3.2a}$ $Fb \in \{li/di\} \Rightarrow Fb1, lb \geq \text{dimensions_ofRule3.3a}$ $Fb \in \{ho\} \Rightarrow Fb1, lb \geq \text{dimension_ofRule3.4a}$ $Fb \in \{mr\} \Rightarrow Fb1, lb \geq \text{dimensions_ofRule3.5a}$ $Ff \geq 1m^2 \wedge l2 \geq 1m$

Function:

 $Fb, Fb1 \in \{li, di, il/di, ho, mr\}$ $Ff \in \{nhs\}$ $Fb \neq Ff$

7.2.b4 Dividing a kitchen

Dimensions:

 $w, l1, l2 \geq 1m$ If *mimimum_level* $\Rightarrow Fb1 \geq 6m^2 (\pm 10\%)$ If *recommended_level* \wedge If *nhab*=4 $\Rightarrow Fb \geq 10,5m^2 (\pm 10\%)$ If *recommended_level* \wedge If *nhab* $\geq 5 \Rightarrow Fb \geq 11,5m^2 + 0,5m^2(n-5) (\pm 10\%)$ $Ff \geq 1m^2$

Functions:

 $Fb, Fb1 \in \{ki\}$ $Ff \in \{nhs\}$

Description (abbreviated):

Rule7.2b < D7: Fb; E > \rightarrow

< D7: Fb1, Ff; E+ {Ff}; w * w/(Fb1, Ff) >

Rule 7.2.c _ Reducing a door opening with light partition wall

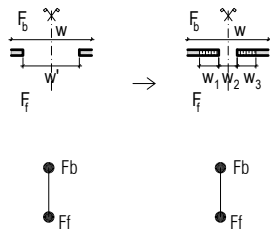

Conditions:

Dimensions:

- $w' > 0.9m \wedge w \geq 1m$
- $w2 \in \{0.8m, 1.0m, 1.2m, 1.6m\}$
- $w' = w1 + w2 + w3$
- $w1, w3 > 0m$

Function:
 $Fb \neq Ff$

Description (abbreviated):

$R7.2c < D7: Fb, Ff; w' * \emptyset > \rightarrow < D7: Fb, Ff; w1 * wul(Fb, Ff), w2 * wul(Fb, Ff) >$

Rule 7.3.a _ Remove part of a room to assign to circulation area

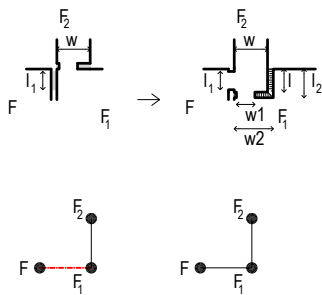

Conditions:

Dimensions:

- $1m \leq l < 2m$
- $0.9m \leq w < 2m$
- $l1, w1 \in \{0.8m, 1.0m, 1.2m, 1.6m\}$

Function:

If (passage_to(F))=0

Private areas

- $F, F1 \in \{be.d, be.t, be.s\}$
- $F2 \in \{nhs, co, co.p\}$

Social areas

- $F, F1 \in \{li, di, li/di, ba.g, ho, mr\}$
- $F2 \in \{nhs, co, co.s, hl\}$

Kitchen

- $F1 \in \{ki\}$
- $F, F2 \in \{Z\}$

Description (abbreviated):

$R7.3a < D7: F, F1, F2; l1 * wub(F, F1), w * wub(F1, F2) > \rightarrow$
 $< D7: Fb; l1 * \emptyset; w * \emptyset, w2 * wul(F1, F2), l2 * wul(F1, F2) >$

Rule 7.3.b _ Remove part of a room area to assign to circulation area

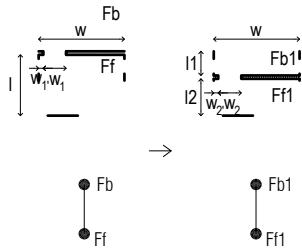

Conditions:

Ff: Bedroom or private bathroom

Dimensions:

$w \leq 2m$
 $0m \leq w1, w1', w2' \leq 1.2m$
 $w2 \in \{0.8m, 0.9m, 1m\}$

If minimum_level $\wedge Ff \in \{be.d\} \Rightarrow l \geq 3,9m \wedge l2 \geq 2,7m \wedge Ff1 \geq 10,5m^2$

If recommended_level $\wedge Ff \in \{be.d\} \Rightarrow l \geq 3,9m \wedge l2 \geq 2,7m \wedge Ff1 \geq 12m^2$

If minimum_level $\wedge Ff \in \{be.t\} \Rightarrow l \geq 3,3m \wedge l2 \geq 2,7m \wedge Ff1 \geq 9m^2$

If recommended_level $\wedge Ff \in \{be.t\} \Rightarrow l \geq 3,3m \wedge l2 \geq 2,7m \wedge Ff1 \geq 14,5m^2$

If minimum_level $\wedge Ff \in \{be.s\} \Rightarrow l \geq 3,3m \wedge l2 \geq 2,1m \wedge Ff1 \geq 8m^2$

If recommended_level $\wedge Ff \in \{be.s\} \Rightarrow l \geq 3,3m \wedge l2 \geq 2,1m \wedge Ff1 \geq 8,5m^2$

If minimum_level $\wedge Ff \in \{ba.p\} \Rightarrow l \geq 2,2m \wedge l2 \geq 1m \wedge Ff1 \geq 3,5m^2$

If recommended_level $\wedge Ff \in \{ba.p\} \Rightarrow l \geq 2,2m \wedge l2 \geq 1m \wedge Ff1 \geq 5m^2$

$1m \leq l1 < 2m$

Function:

$Ff, Ff1 \in \{be.d, be.t, be.s, ba.p\} \wedge Ff = Ff1$

$Fb, Fb1 \in \{nhs, co.p, co, co.s\} \wedge Fb = Fb1$

Ff: Guest bathroom

Dimensions:

$w \leq 2m$
 $1m \leq l1 < 2m$
 $0m \leq w1, w1', w2' \leq 1.2m$
 $w2 \in \{0.8m, 0.9m, 1m\}$

If minimum_level $\wedge Ff \in \{ba.g\} \Rightarrow l \geq 2,2m \wedge l2 \geq 1m \wedge Ff1 \geq 1m^2$

If recommended_level $\wedge Ff \in \{ba.g\} \Rightarrow l \geq 2,2m \wedge l2 \geq 1m \wedge Ff1 \geq 2m^2$

Function:

$Ff, Ff1 \in \{ba.g\} \wedge Ff = Ff1$

$Fb, Fb1 \in \{Z\} \wedge Fb = Fb1$

Regra 7.3.c _ Remove part of the bedroom area to assign to circulation area

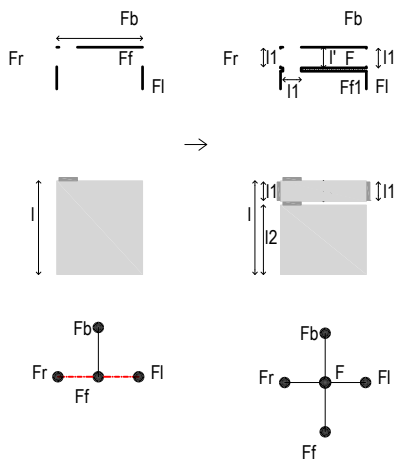

Conditions:

Dimensions:

$l1 \in \{0.8m, 0.9m, 1m\}$
 $1m \leq l' \leq 1.5m$

If minimum_level $\wedge Ff \in \{be.s\} \Rightarrow l2 \geq 2,1m \wedge Ff1 \geq 8m^2$

If recommended_level $\wedge Ff \in \{be.s\} \Rightarrow l2 \geq 2,1m \wedge Ff1 \geq 8,5m^2$

If minimum_level $\wedge Ff \in \{be.t\} \Rightarrow l2 \geq 2,7m \wedge Ff1 \geq 9m^2$

If recommended_level $\wedge Ff \in \{be.t\} \Rightarrow l2 \geq 2,7m \wedge Ff1 \geq 14,5m^2$

If minimum_level $\wedge Ff \in \{be.d\} \Rightarrow l2 \geq 2,7m \wedge Ff1 \geq 10,5m^2$

If recommended_level $\wedge Ff \in \{be.d\} \Rightarrow l2 \geq 2,7m \wedge Ff1 \geq 12m^2$

$F \geq 1m^2$

Function:

$Ff, Fr, Fl \in \{be.d, be.t, be.s, ba.p, cl\}$

$Fb, F \in \{nhs, co.p, co, co.s\}$

Description (abbreviated):

R7.3c < D1: Fb, Ff, Fl, Fr > \rightarrow < D1: Fb, Ff1, Fl, Fr, F; $w * wul(F, Ff1)$ >

Rule 7.4.a _ Changing a room's dimension (enlarging or reducing) by "moving" a wall (eliminating and adding a wall)

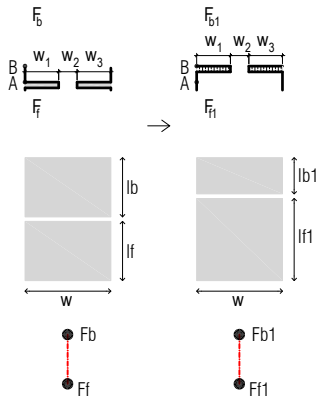

Conditions:

Dimensions:
 $1m \leq w \leq 2m$
 $0m \leq w_1, w_2, w_3 \leq 2m$
 $0,5m \leq \text{dist}(A, B) \leq 1m$

Description (abbreviated):

$R7.4a < D7: F_b, F_f; A, w * wub(F_b, F_f) > \rightarrow$
 $< D7: F_{b1}, F_{f1}; B, w * wul(F_{b1}, F_{f1}) >$

7.4.a1 Changing a bedroom dimension

Dimensions:

$(F_b = \text{be.d} \Rightarrow F_{b1} \geq 10,5m^2 \wedge l_{b1} \geq 2,7m) \vee (F_f = \text{be.d} \Rightarrow F_{f1} \geq 10,5m^2 \wedge l_{f1} \geq 2,7m)$
 $(F_b = \text{be.t} \Rightarrow F_{b1} \geq 9m^2 \wedge l_{b1} \geq 2,1m) \vee (F_f = \text{be.t} \Rightarrow F_{f1} \geq 9m^2 \wedge l_{f1} \geq 2,1m)$
 $(F_b = \text{be.s} \Rightarrow F_{b1} \geq 8m^2 \wedge l_{b1} \geq 2,1m) \vee (F_f = \text{be.s} \Rightarrow F_{f1} \geq 9m^2 \wedge l_{f1} \geq 2,1m)$

Function:

$F_b, F_{b1} \in \{\text{be.d, be.t, be.s}\} \wedge F_f, F_{f1} \in \{\text{be.d, be.t, be.s, cl, ba.p, nhs}\} \wedge F_b = F_{b1} \wedge F_f = F_{f1} \wedge F_b, F_{b1} \neq F_f, F_{f1}$
 $F_f, F_{f1} \in \{\text{be.d, be.t, be.s}\} \wedge F_b, F_{b1} \in \{\text{be.d, be.t, be.s, cl, ba.p, nhs}\} \wedge F_b = F_{b1} \wedge F_f = F_{f1} \wedge F_b, F_{b1} \neq F_f, F_{f1}$

7.4.a2 Changing a bathroom dimension

Dimensions:

$(F_b = \text{ba.p} \Rightarrow F_{b1} \geq 3,5m^2 \wedge l_{b1} \geq 1m) \vee (F_f = \text{ba.p} \Rightarrow F_{f1} \geq 3,5m^2 \wedge l_{f1} \geq 1m)$

Function:

$F_b, F_{b1} \in \{\text{ba.p}\} \wedge F_f, F_{f1} \in \{\text{be.d, be.t, be.s, cl, ba.p, nhs, hs}\} \wedge F_b = F_{b1} \wedge F_f = F_{f1} \wedge F_b, F_{b1} \neq F_f, F_{f1}$

7.4.a3 Changing a social room dimension

Dimensions:

$(F_b = \text{li} \Rightarrow F_{b1}, l_{b1} \geq \text{dimensions_ofRule3.1a} \wedge l_{f1} \geq 1m) \vee (F_f = \text{li} \Rightarrow F_{f1}, l_{f1} \geq \text{dimensions_ofRule3.1a} \wedge l_{b1} \geq 1m)$
 $(F_b = \text{di} \Rightarrow F_{b1}, l_{b1} \geq \text{dimensions_ofRule2.2a} \wedge l_{f1} \geq 1m) \vee (F_f = \text{di} \Rightarrow F_{f1}, l_{f1} \geq \text{dimensions_ofRule2.2a} \wedge l_{b1} \geq 1m)$
 $(F_b = \text{li/di} \Rightarrow F_{b1}, l_{b1} \geq \text{dimensions_ofRule2.3a} \wedge l_{f1} \geq 1m) \vee (F_f = \text{li/di} \Rightarrow F_{f1}, l_{f1} \geq \text{dimensions_ofRule2.3a} \wedge l_{b1} \geq 1m)$
 $(F_b = \text{ho} \Rightarrow F_{b1}, l_{b1} \geq \text{dimension_ofRule2.4a} \wedge l_{f1} \geq 1m) \vee (F_f, l_{f1} \geq \text{dimensions_ofRule2.4a} \wedge l_{b1} \geq 1m)$
 $(F_b = \text{mr} \Rightarrow F_{b1}, l_{b1} \geq \text{dimensions_ofRule2.5a} \wedge l_{f1} \geq 1m) \vee (F_f = \text{li} \Rightarrow F_{f1}, l_{f1} \geq \text{dimensions_ofRule2.5a} \wedge l_{b1} \geq 1m)$

Function:

$F_b, F_{b1} \in \{\text{li, di, li/di, ho, mr}\} \wedge F_f, F_{f1} \in \{Z\} \wedge F_b = F_{b1} \wedge F_f = F_{f1} \wedge F_b, F_{b1} \neq F_f, F_{f1}$

7.4.a4 Changing a guest bathroom dimension

Dimensions:

$(F_b = \text{ba.g} \Rightarrow F_{b1} \geq 1m^2 \wedge l_{b1} \geq 1m) \vee (F_f = \text{ba.g} \wedge l_{f1} \leq 1,2m \Rightarrow F_{f1} \geq 1m^2 \wedge 2m \geq l_{f1} \geq 1m)$

Function:

$F_b, F_{b1} \in \{\text{ba.g}\} \wedge F_f, F_{f1} \in \{Z\} \wedge F_b = F_{b1} \wedge F_f = F_{f1} \wedge F_b, F_{b1} \neq F_f, F_{f1}$

Rule 7.4.b _ Changing a room's dimension (enlarging or reducing) by "moving" a wall (eliminating and adding a wall)

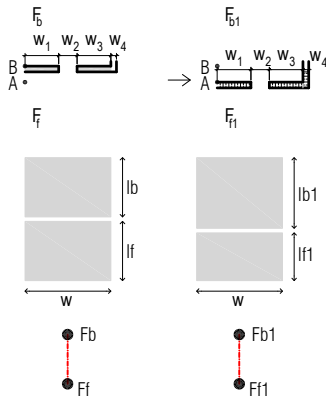

Conditions:

Dimensions:
 $1m \leq w \leq 2m$
 $w_1, w_2, w_3 \geq 0m$
 $0.1m \leq w_4 \leq 0.3m$
 $0,5m \leq dist(A, B) \leq 1m$

Description

$R7.4b < D7: Fb, Ff; A, w^*ub > \rightarrow < D7: Fb1, Ff1; B, w^*ul >$

7.4.b1 Changing a bathroom dimension

Dimensions:
 $(Fb=ba.p \Rightarrow Fb1 \geq 3,5m^2 \wedge lb1 \geq 1m) \vee (Ff=ba.p \Rightarrow Ff1 \geq 3,5m^2 \wedge lf1 \geq 1m)$

Function:
 $Fb, Fb1 \in \{ba.p\} \wedge Ff, Ff1 \in \{be.d, be.t, be.s, cl, ba.p, nhs, hs\} \wedge Fb=Fb1 \wedge Ff=Ff1 \wedge Fb, Fb1 \neq Ff, Ff1$

7.4.b2 Changing a guest bathroom dimension

Dimensions:
 $(Fb=ba.g \Rightarrow Fb1 \geq 1m^2 \wedge lb1 \geq 1m) \vee (Ff=ba.g \wedge lf \leq 1,2m \Rightarrow Ff1 \geq 1m^2 \wedge 2m \geq lf1 \geq 1m)$

Function:
 $Fb, Fb1 \in \{ba.g\} \wedge Ff, Ff1 \in \{Z\} \wedge Fb=Fb1 \wedge Ff=Ff1 \wedge Fb, Fb1 \neq Ff, Ff1$

Rule 7.4.c _ Changing a room's dimension - reducing - by "moving" a wall (eliminating and adding a wall)

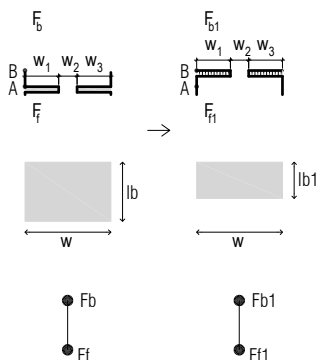

Conditions:

Dimensions:
 $0,9m \leq w \leq 1,2m$
 $0m \leq w_1, w_2, w_3 \leq 1.2m$
 $lb \geq 2m$
 $lb1 \geq 1m$
 $0,5m \leq dist(A, B) \leq 1m$
 $Fb1 \geq 1m^2$

Function:

$Ff, Ff1 \in \{ba.g\} \wedge Fb, Fb1 \in \{Z\} \wedge Fb=Fb1 \wedge Ff=Ff1 \wedge Fb, Fb1 \neq Ff, Ff1$

Description (abbreviated):

$R7.4c < D7: Fb, Ff; B, w^*wub(Fb, Ff) > \rightarrow < D7: Fb1, Ff1; A, w^*wul(Fb1, Ff1) >$

Rule 7.4.d _ Divide a room in two autonomous ones and enlarging one of them

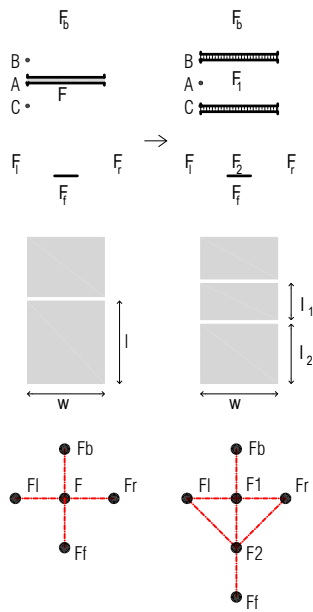

Conditions:

- Dimensions:
- $1m \leq w \leq 2m$
- $l1 \geq lm$
- $F1 \geq 1m^2$
- $0,5m \leq dist(A, B) \leq 1m$
- $0,5m \leq dist(A, C) \leq 1m$

Function:

- $F1 \vee Fb \vee Fr \in \{co, co.s, co.p, nhs, hl\}$
- $F1 \vee F1 \vee Fr \in \{ext\}$
- $F1 \in \{nhs\}$

7.4.c1 Dividing a bedroom in two autonomous ones and enlarging the bedroom

Dimensions:

- If $mimimum_level \wedge F \in \{be.d\} \Rightarrow F2 \geq 10,5m^2 \wedge w, l2 \geq 2,7m$
- If $recommended_level \wedge F \in \{be.d\} \Rightarrow F2 \geq 12m^2 \wedge w, l2 \geq 2,7m$
- If $mimimum_level \wedge F \in \{be.t\} \Rightarrow F2 \geq 9m^2 \wedge w, l2 \geq 2,1m$
- If $recommended_level \wedge F \in \{be.t\} \Rightarrow F2 \geq 14,5m^2 \wedge w, l2 \geq 2,1m$
- If $mimimum_level \wedge F \in \{be.s\} \Rightarrow F2 \geq 7m^2 \wedge w, l2 \geq 2,1m$
- If $recommended_level \wedge F \in \{be.s\} \Rightarrow F2 \geq 8,5m^2 \wedge w, l2 \geq 2,1m$

Function:

- $F, F2 \in \{be.d, be.t, be.s\}$
- $F = F2$

7.4.c2 Dividing a social room in two autonomous ones and enlarging the bedroom

Dimensions:

- $F \in \{li\} \Rightarrow F2, l2 \geq dimensions_ofRule3.1a$
- $F \in \{di\} \Rightarrow F2, l2 \geq dimensions_ofRule3.2a$
- $F \in \{li/di\} \Rightarrow F2, l2 \geq dimensions_ofRule3.3a$
- $F \in \{ho\} \Rightarrow F2, l2 \geq dimension_ofRule3.4a$
- $F \in \{mr\} \Rightarrow F2, l2 \geq dimensions_ofRule3.5a$

Function:

- $F, F2 \in \{li, di, li/di, ho, mr\}$
- $F = F2$

Description (abbreviated):

- $R7.4d < D7: F, F1, F1, Fr; w * wub(Fb, F) > \rightarrow$
- $< D7: F1, F2, F1, F1, Fr; w * wul(Fb, F1), w * wul(F1, F2) >$

Rule 7.5.a _ Changing a room layout and assignment, next to middle wall (types c and d)

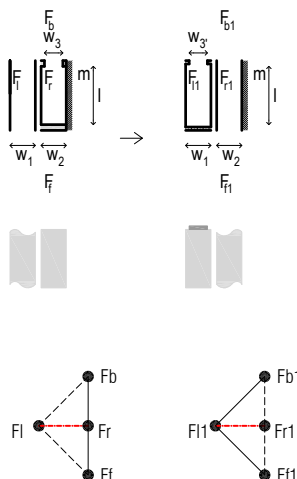

Conditions:

- Dimensions:
- $1m \leq w1, w2 \leq 1.5m$
- $1m \leq l \leq 2m$
- $0m \leq w3 \leq 0.9m$
- $w3' = 0.8m$
- $F11 \geq 1m^2$

Function:

- $F1, F11, Fb, Fb1, Ff, F11 \in \{nhs, co, co.s, hl\}$
- $Fr, F11 \in \{ba.g, st\}$

Description (abbreviated):

- $R7.5a < D7: F1, Fr; w2 * wub(Fb, Fr), w2 * wub(Fr, Ff) > \rightarrow$
- $< D7: Fb1, F11; w1 * wul(Fb1, F11), w1 * wul(F11, F1) >$

Rule 7.5.b _ Changing room layout and assignment, next to middle wall (types c and d)

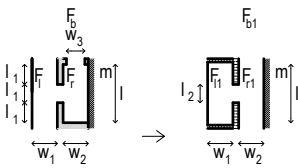

Conditions:

- Dimensions:
 $1m \leq w1, w2 \leq 1.5m$
 $1m \leq l \leq 2m$
 $0m \leq w3 \leq 0.9m$
 $0m \leq l1 \leq 2m$
 $l2 = 0.8m$
 $F11 \geq 1m^2$

Function:

- $F1, Fr1 \in \{nhs, co, co.s\}$
 $Fb, Fb1 \in \{nhs, co.p, co, co.s\}$
 $Fr, F11 \in \{ba.g\}$

Description

- $R7.5b < D7: F1, Fr; w1 * \emptyset, w2 * ub > \rightarrow$
 $< D7: Fb1, F11; w1 * ul, w2 * \emptyset >$

Rule 7.5.c _ Changing room layout and assignment, next to middle wall (types c and d)

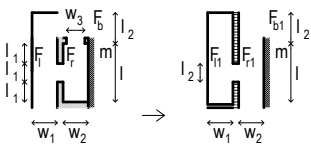

Conditions:

- Dimensions:
 $1m \leq w1, w2, l2 \leq 1.5m$
 $1m \leq l \leq 2m$
 $0m \leq w3 \leq 0.9m$
 $0m \leq l1 \leq 2m$
 $l2 = 0.8m$
 $F11 \geq 1m^2$

Function:

- $F1, Fr1 \in \{nhs, co, co.s\}$
 $Fb, Fb1 \in \{nhs, co.p, co, co.s\}$
 $Fr, F11 \in \{ba.g\}$

Description

- $R7.5c < D7: F1, Fr; w1 * \emptyset, w2 * ub > \rightarrow$
 $< D7: Fb1, F11; w1 * ul, w2 * \emptyset >$

Rule 7.6.a _ Changing a door position (aligned with door in front)

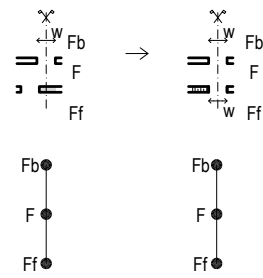

Conditions:
 Dimensions:
 $w \in \{0.8m, 0.9m, 1m, 1.2m\}$
 Function:
 $F \in \{nhs, co.p, co.s, co, hl\}$
 $Fb, Ff \in \{Z\}$

Rule 7.6.b _ Changing a door position (change door next to partition wall)

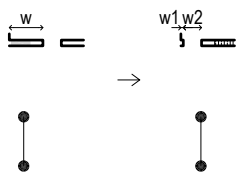

Conditions:
 Dimensions:
 $w \leq 2.5m$
 $w2 \in \{0.8m, 0.9m, 1m, 1.2m\}$
 $w1 = 0,1m$

Rule 7.6.c _ Changing a door position (change door to a perpendicular wall)

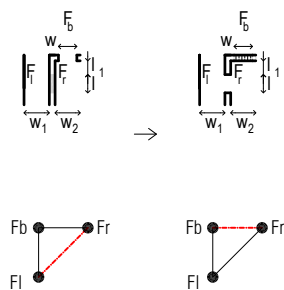

Conditions:
 Dimensions:
 $w1, w2 \geq 0,9m$
 $l, w \in \{0.8m, 0.9m, 1m\}$
 $l1 \geq 0,7m$
 $1m^2 \leq Fr \leq 3m^2$
 Function:
 $Fb \in \{co, co.s, co.p\} \wedge Fb(\text{passage_to}(x)) = \text{TRUE}, x \in \{be.d, be.t, be.s\}$
 $Ff \in \{co\} \wedge Ff(\text{passage_to}(x)) = \text{TRUE}, \forall x: x \in \{ki, li, di, li/di, ho, mr, hl\}$
 $Fr \in \{ba.g\}$

Description (abbreviated):
 $R7.6.c < D7: Ff, Fr, Fb; l^*wub(Ff, Fr) > \rightarrow$
 $< D7: Ff, Fr, Fb; w^*wul(Fb, Fr), l^*\emptyset >$

Rule 7.6.d _ Changing a door position (change door to a perpendicular wall)

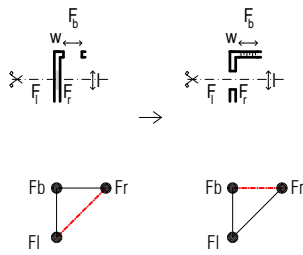

Conditions:

Dimensions:

$l, w \in \{0.8m, 0.9m, 1m\}$

$1m^2 \leq Fr \leq 3m^2$

Function:

$F_l, F_b, F_r \in \{Z\}$

$F_l (\text{passage_to}(x)) = \text{TRUE} \vee F_l (\text{next_to}(x)) = \text{TRUE}, x \in \{\text{nhs}, \text{co}, \text{co.s}, \text{hl}\}$

Description (abbreviated):

$R7.6.d < D7: Fr, F_b; w^* \emptyset, l^* wub(F_l, Fr) > \rightarrow$

$< D7: Fr, F_b; w^* wul(F_b, Fr), l^* \emptyset >$

Rule 7.6.e _ Changing a door position (change door from co or co.s to co.p)

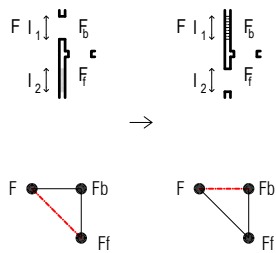

Conditions:

Dimensions:

$l_2 \in \{0.8m, 0.9m, 1m\}$

Function:

$F \in \{\text{be.d}, \text{be.t}, \text{be.s}\}$

$F_b \in \{\text{co}, \text{co.s}, \text{hl}\}$

$F_f \in \{\text{co.p}\}$

Description (abbreviated):

$R7.6.e < D7: F_f, F_r, F; l_1^* \emptyset, l_2^* wub(F, F_f) > \rightarrow$

$< D7: F_f, F_r, F; l_1^* wul(F, F_b), l_2^* \emptyset >$

Rule 7.7 _ Changing from step 7 to step 8

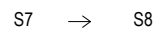
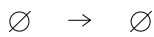

Conditions:

$\forall \{\beta_6, \beta_7, \beta_8, \beta_9, \beta_{10}, \beta_{11}\}: \{\beta_6, \beta_7, \beta_8, \beta_9, \beta_{10}, \beta_{11}\} \subset E$

Description (abbreviated):

$R7.7 < D7: S7 > \rightarrow < D8: S8 >$

Rule 8.1.a _ Allocating of water detectors (wd)

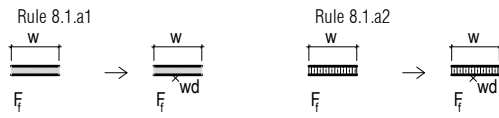

Conditions:

$$X \supset \{wdn\} \wedge X \supset \{wdn\}$$

Position:

$$0,2m \leq w \leq 0,5m$$

$$wd(mounted_on(z)) = TRUE \wedge z \in \{skirting_board\}$$

Function:

$$F \in \{ba.p, ba.g, ki, la\}$$

Description (abbreviated):

$$R8.1a1 < D8: F; wub(F); \emptyset; X' > \rightarrow < D8: F; wub(F); wd; X' + \{wd\} >$$

$$R8.1a2 < D8: F; wu/(F); \emptyset; X' > \rightarrow < D8: F; wu/(F); wd; X' + \{wd\} >$$

Rule 8.1.b _ Allocating of smoke detectors (sd)

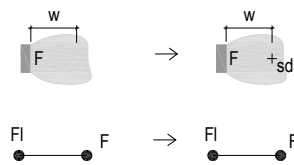

Conditions:

$$X \supset \{sdn\} \wedge X \supset \{sdn\} \wedge sd1 \ sd2 \geq 4m$$

Position:

$$1m \leq w \leq 1,5m$$

$$sd(mounted_on(z)) = TRUE \wedge z \in \{ceilling\}$$

Function:

$$F \in \{lh, sh\}$$

$$F \in \{hl, co, co.s, co.p\}$$

Description (abbreviated):

$$R8.1b < D8: F; \emptyset; X' > \rightarrow < D8: F; sd; X' + \{sd\} >$$

Rule 8.1.c _ Allocating of temperature detectors (td)

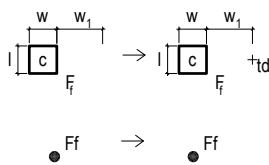

Conditions:

$$X \supset \{tdn\} \wedge X \supset \{tdn\} \wedge td1 \ td2 \geq 4m$$

Position:

$$0,5m \leq w, l \leq 0,7m$$

$$1m \leq w1 \leq 1,5m$$

$$td(mounted_on(z)) = TRUE \wedge z \in \{ceilling\}$$

Function:

$$F \in \{ki\}$$

Description (abbreviated):

$$R8.1c < D8: F; \emptyset; X' > \rightarrow < D8: F; td; X' + \{td\} >$$

Rule 8.1.d _ Allocating of gas detectors (gd)

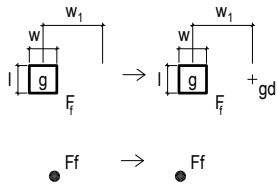

Conditions:

$$X \supset \{gdn\} \wedge X \supset \{gdn\} \wedge \overline{gd1 \ gd2} \geq 4m$$

Position:

$$0,2m \leq w \leq 0,7m$$

$$1m \leq w1 \leq 4m$$

$$If \ natural_gas \ gd \ (mounted-on(z)) = TRUE \ \wedge \ z \in \{ceiling\}$$

$$If \ propane_gas \ gd \ (mounted-on(z)) = TRUE \ \wedge \ z \in \{skirting_board\}$$

Function:

$$Ff \in \{ki, la\}$$

Description (abbreviated):

$$R8.1d < D8: Ff; \emptyset; X' > \rightarrow < D8: Ff; gd; X' + \{gd\} >$$

Note:

For this rule the representation of the elevation or section of the division would be needed in order to specify the exact position of the sensors from the ceiling and from the floor. Natural gas detector must be placed lower than 0.30m from the floor. Propane gas detector must be placed higher than 0.30m from the ceiling.

Rule 8.1.e _ Allocating of movement detectors (md) (for the hall and corridors with doors to the exterior)

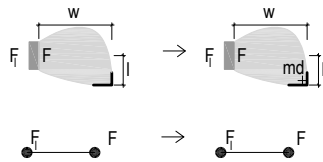

Conditions:

$$X \supset \{mdn\} \wedge X \supset \{mdn\}$$

Position:

$$1m \leq w \leq 3m$$

$$0,5m \leq l \leq 3m$$

$$md \ (mounted-on(z)) = TRUE \ \wedge \ z \in \{moulding_panels\}$$

Function:

$$F \in \{hl\}$$

$$Fl \in \{lh, sh\}$$

Description (abbreviated):

$$R8.1e < D8: F, Fl; \emptyset; X' > \rightarrow < D8: F, Fl; md; X' + \{md\} >$$

Rule 8.10.a1 _ Allocating of interfaces: control panel (i)

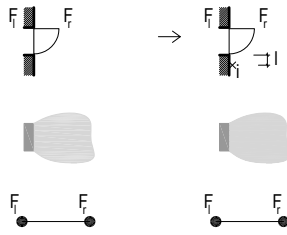

Conditions:

$$X \supset \{in\} \wedge X \not\supset \{in\}$$

Position:

$$0.2m \leq l \leq 0.8m$$

$$i(\text{mounted-on}(z)) = \text{TRUE} \wedge z \in \{\text{wall}\}$$

Function:

$$F_l \in \{\text{lh}, \text{sh}\}$$

$$F_r \in \{\text{hl}, \text{co}, \text{co.s}\}$$

Description (abbreviated):

$$R8.10a1 < D8: F_l, F_r; wus(F_l, F_r); \emptyset; X' > \rightarrow$$

$$< D8: F_l, F_r; wus(F_l, F_r); i; X' + \{i\} >$$

Rule 8.10.a2 _ Allocating of interfaces: control panel (i)

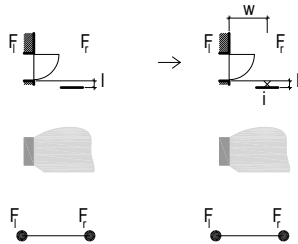

Conditions:

$$X \supset \{in\} \wedge X \not\supset \{in\}$$

Position:

$$l \leq 0.25m$$

$$0.9m \leq w \leq 1.5m$$

$$i(\text{mounted-on}(z)) = \text{TRUE} \wedge z \in \{\text{wall}\}$$

Function:

$$F_l \in \{\text{lh}, \text{sh}\}$$

$$F_r \in \{\text{hl}, \text{co}, \text{co.s}\}$$

Description (abbreviated):

$$R8.10a2 < D8: F_l, F_r; \emptyset; X' > \rightarrow < D8: F_l, F_r; i; X' + \{i\} >$$

Rule 8.10.a3 _ Allocating of interfaces: control panel (i)

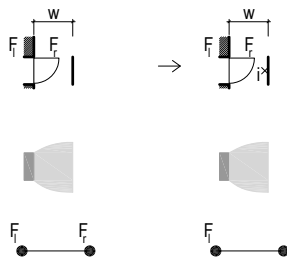

Conditions:

$$X \supset \{in\} \wedge X \not\supset \{in\}$$

Position:

$$1m \leq w \leq 2m$$

$$i(\text{mounted-on}(z)) = \text{TRUE} \wedge z \in \{\text{wall}\}$$

Function:

$$F_l \in \{\text{lh}, \text{sh}\}$$

$$F_r \in \{\text{hl}, \text{co}, \text{co.s}\}$$

Description (abbreviated):

$$R8.10a3 < D8: F_l, F_r; \emptyset; X' > \rightarrow < D8: F_l, F_r; i; X' + \{i\} >$$

Rule 8.10.b1 _ Allocating of interfaces: multifunctional switches (ms)

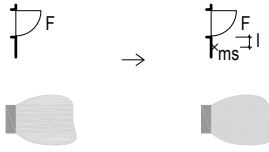

Conditions:

$$X \supset \{ms\} \wedge X \supset \{ms\}$$

Position:

$$0.1m \leq l \leq 0.5m$$

$$ms(\text{mounted-on}(z)) = \text{TRUE} \wedge z \in \{\text{wall}\}$$

Function:

$$F \in \{\text{ba.p, ba.g, cl, st}\}$$

Description (abbreviated):

$$R8.10b1 \langle D8: F; \emptyset; X \rangle \rightarrow \langle D8: F; ms; X + \{ms\} \rangle$$

Rule 8.10.b2 _ Allocating of interfaces: multifunctional switches (ms)

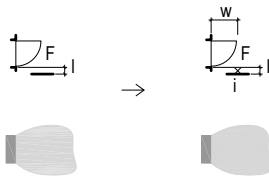

Conditions:

$$X \supset \{ms\} \wedge X \supset \{ms\}$$

Position:

$$l \leq 0.25m$$

$$0.25m \leq w \leq 1m$$

$$ms(\text{mounted-on}(z)) = \text{TRUE} \wedge z \in \{\text{wall}\}$$

Function:

$$F \in \{\text{ba.p, ba.g, cl, st}\}$$

Description (abbreviated):

$$R8.10b2 \langle D8: F; \emptyset; X \rangle \rightarrow \langle D8: F; ms; X + \{ms\} \rangle$$

Rule 8.10.b3 _ Allocating of interfaces: multifunctional switches (ms)



Conditions:

$$X \supset \{ms\} \wedge X \supset \{ms\}$$

Position:

$$0.1m \leq l \leq 0.5m$$

$$ms(\text{mounted-on}(z)) = \text{TRUE} \wedge z \in \{\text{wall}\}$$

Function:

$$F \in \{\text{ba.p, ba.g, cl, st}\}$$

Description (abbreviated):

$$R8.10b3 \langle D8: F; \emptyset; X + \{ms\} \rangle \rightarrow \langle D8: F; ms; X + \{ms\} \rangle$$

Rule 8.10.b4 _ Allocating of interfaces: multifunctional switches (ms)

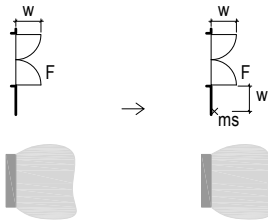

Conditions:

$$X \supset \{ms\eta\} \wedge X \not\supset \{ms\eta\}$$

Position:

$$0.4m \leq w \leq 1m$$

$$ms(mounted-on(z)) = TRUE \wedge z \in \{wall\}$$

Function:

$$F \in \{ba.p, ba.g, cl, si\}$$

Description (abbreviated):

$$R8.10b4 < D8: F; \emptyset; X' > \rightarrow < D8: F; ms; X' + \{ms\} >$$

Rule 8.10.b5 _ Allocating of interfaces: multifunctional switches (ms)

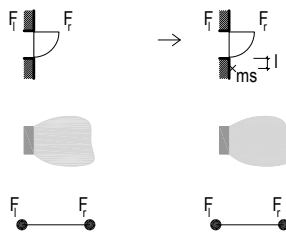

Conditions:

$$X \supset \{ms\eta\} \wedge X \not\supset \{ms\eta\}$$

Position:

$$0.2m \leq l \leq 0.8m$$

$$ms(mounted-on(z)) = TRUE \wedge z \in \{wall\}$$

Function:

$$F1 \in \{lh, sh\}$$

$$Fr \in \{hl, co, co.s\}$$

Description (abbreviated):

$$R8.10b5 < D8: F1, Fr; \emptyset; X' > \rightarrow < D8: F1, Fr; ms; X' + \{ms\} >$$

Note:

For this rule the representation of the elevation or section of the division would be needed in order to specify the exact position of the switch in order not to conflict with the control panel specified by Rule 8.10a1

Rule 8.10.b6 _ Allocating of interfaces: multifunctional switches (ms)

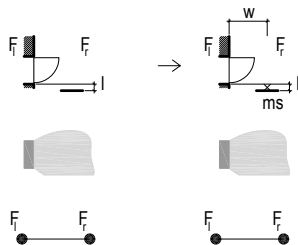

Conditions:

$$X \supset \{in\} \wedge X \not\supset \{in\}$$

Position:

$$l \leq 0.25m$$

$$0.9m \leq w \leq 1.5m$$

$$i(mounted-on(z)) = TRUE \wedge z \in \{wall\}$$

Function:

$$F1 \in \{lh, sh\}$$

$$Fr \in \{hl, co, co.s\}$$

Description (abbreviated):

$$R8.10b6 < D8: F1, Fr; \emptyset; X' > \rightarrow < D8: F1, Fr; ms; X' + \{ms\} >$$

Note:

For this rule the representation of the elevation or section of the division would be needed in order to specify the exact position of the switch in order not to conflict with the control panel specified by Rule 8.10a1

APPENDIX 4

A dwelling transformation

This Appendix provides an example of the entire rehabilitation process, from identifying the family characteristics and the existing dwelling to the final design for the adapted dwelling (see Figure 5).

The chosen example shows how the rehabilitation process can be managed using the methodology proposed in this thesis when an architect is confronted with a family and their current dwelling to rehabilitate.

Throughout this 5th chapter tables will be used to show data, as a simulation of what would be used in a computer interface for a generative shape grammar software.

The INPUTs represent the data that users would have to introduce and the OUTPUTs represent the reply data that the system would give to the user.

This example contains a family profile that was used during the experiments described in *Part 2: Chapter 1.4*, and one of the dwellings that belongs to the corpus.

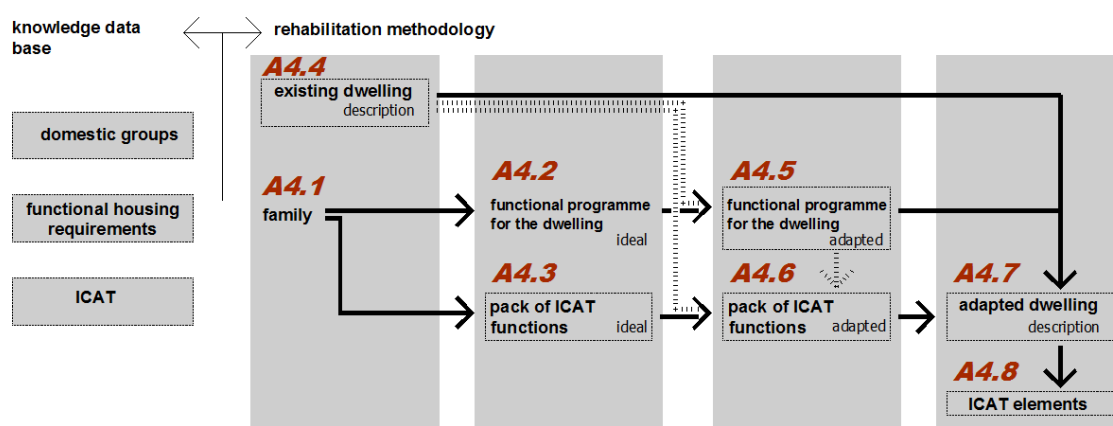
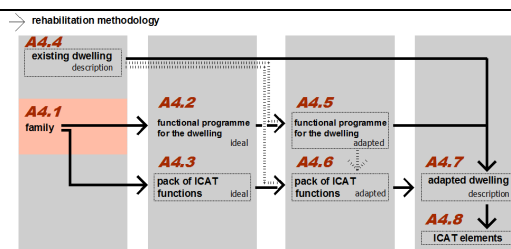

Figure 5 – Rehabilitation methodology – sequence/sub-chapters from which the example derivation is developed.

A4:1 DEFINITION OF THE FAMILY



This section introduces the data on the family characteristics for the purpose of understanding their requirements and proposing the ideal functional programme (see next section A4:2) and ideal ICAT pack (see A4:3). This data is shown in Table 9.

The number of residents and their kinship enables the family size to be understood and the possibilities for grouping different members of the family in bedrooms.

The “period of occupation” essentially refers to the situation regarding children of separated couples, who may stay in the mother’s/father’s home for short periods of time.

If a member of the family has restricted mobility or a disability, the functional and dimensional requirements for the dwelling will be more demanding, in order to facilitate mobility.

Input 1	Define family	Composition	(number of residents)	4	
			(names/ages)	José/40 Maria/36 Catarina/8 Gonçalo/4	
			(kinship)	José and Maria, couple Catarina and Gonçalo, siblings and children of the couple	
			Period of occupation	José / 100%, Maria / 100% Catarina / 100% Gonçalo / 100%	
			Special needs	(restricted mobility)	No
				(disability)	No
				(visual impairment)	No
				(hearing impairment)	No

Table 9 – Definition of the family

A4:2 DEFINITION OF THE IDEAL FUNCTIONAL PROGRAMME

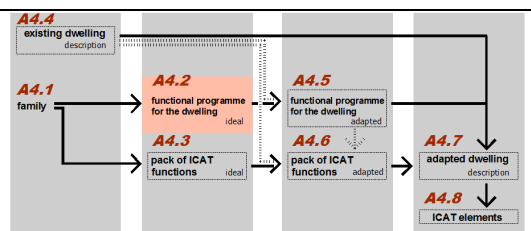

This section exemplifies how the ideal functional programme for the dwelling is structured.

This example is based on the ideal functional programme defined in *Part 2: Chapter 2.2* and the family characteristics are as described in the previous section (A4:1).

In this step the ideal functional programme is generated (using tables and flowcharts or automatically using computer software) as shown in the table below (Table 10). Firstly, the family chooses the desired quality level – minimum or recommended (Input 2). Secondly, the preliminary ideal programme is generated (Output 1). If the functional programme does not completely meet family needs, or if the family wishes to emphasise certain characteristics, the system allows additional spaces and topology to be introduced in order of priority, using Input 3 and Input 4 respectively.

By combining Output 1 with Input 3 and 4 the final ideal functional programme is obtained – Output 2 – which will be used in the following steps of the rehabilitation process.

Input 2	Define desired quality level	<i>Recommended</i>
Output 1	Preliminary ideal functional programme	Spaces

	(typology)	T3
	(space/connection / area)	Double bedroom / isolated / 12m ²
		2 single bedrooms / isolated / 8.5x2m ²
		Kitchen / isolated / 10.5m ²
		Laundry / demarcated / 3.5m ²
		Living room / demarcated / 16m ²
		Dining room / demarcated / 9.5m ²
		Media room / included / 3m ²
		Private bathroom. first / isolated / 5m ²
		Private bathroom. second / isolated / 2m ²
		Guest bathroom / isolated / 1m ²
		Home office / included / 3m ²
		Storage areas / demarcated / 4.5m ²
		Hall + circulation area
	Priority topology	
		Bedrooms1,2,3 DOOR TO private corridor
		Bedroom1 NEXT/CLOSE TO Bedroom2
		Bedroom1 NEXT/CLOSE TO Bedroom3
		Bedroom2 NEXT/CLOSE TO Bedroom3
		Bedrooms FAR FROM Hall
	Bedrooms have large DEPTH	
	Living/dining room PASSAGE TO circulation area	
	Living room PASSAGE TO Dining room	
	Living room NEXT TO Hall	
	Living room CLOSE TO Guest bathroom	
	Living/dining room DISTRIBUTEDNESS "c" or "d"	
	Dining room CLOSE TO Hall	
	Dining room CLOSE TO Guest bathroom	
	Dining room PASSAGE/NEXT TO Kitchen	
	Home office INCLUDED IN Living or Dining room	
	Media room INCLUDED IN Living or Dining room	
	Kitchen PASSAGE TO Circulation area	
	Kitchen CLOSE TO Hall	
	Kitchen PASSAGE/NEXT TO Dining room	
	Kitchen CLOSE TO Guest bathroom	
	Laundry PASSAGE TO Kitchen	
	Private bathroom1 PASSAGE TO circulation area, bedroom	
	Private bathroom2 PASSAGE TO circulation area , bedroom	
	Guest bathroom PASSAGE TO circulation area	

Input 3	Define additional spaces
	1. Dining room / isolated (≥12m ²)
	2. Home office / isolated
	3. Two complete private bathrooms (one may be smaller)

Input 4	Define additional or priority topology		
		1. Single bedrooms NEXT TO double bedroom	
		2. Private bathroom INSIDE private area	
		3. Dining room NEXT TO kitchen	
		4. Living room NEXT TO hall	
Output 2	Final ideal functional program	Floor area needed	105m ² (recommended) (95m ² , minimum)
		N° of habitable spaces	7
		Spaces	
		(typology)	T3
		(space / connection / area)	(hs) Double bedroom / isolated / 12m ²
			(hs) 2 single bedrooms / isolated / 8.5x2m ²
			(hs) Kitchen / isolated / 10.5m ²
			Laundry / demarcated / 3.5m ²
			(hs) Living room + media room / demarcated / 19m ²
			(hs) Dining room / isolated / 12m ²
			Private Bathroom / isolated / 5m ²
			Private Bathroom / isolated / 5m ²
			Guest bathroom / isolated / 1m ²
			(hs) Home office / isolated / 7m ²
			Storage areas / demarcated / 4.5m ²
			Circulations / demarcated / ±16m ²
		Priority topology	
			Bedrooms1,2,3 PASSAGE TO private corridor
			1. Bedroom1 NEXT TO Bedroom2
			1. Bedroom1 NEXT TO Bedroom3
			1. Bedroom2 NEXT TO Bedroom3
			Bedrooms FAR FROM Hall
			Bedrooms have large DEPTH
			Living/dining room PASSAGE TO circulation area
			Living room PASSAGE TO Dining room
	4. Living room NEXT TO Hall		
	Living room CLOSE TO Guest bathroom		
	Living/dining room DISTRIBUTEDNESS "c" or "d"		
	Dining room CLOSE TO Hall		
	Dining room CLOSE TO Guest bathroom		
	3. Dining room NEXT TO Kitchen		
	Home office INCLUDED IN Living or Dining room		
	Media room INCLUDED IN Living or Dining room		
	Kitchen PASSAGE TO Circulation area		
	Kitchen CLOSE TO Hall		
	3. Kitchen NEXT TO Dining room		

	<i>Kitchen CLOSE TO Guest bathroom</i>
	<i>Laundry PASSAGE TO Kitchen</i>
	2. Private bathroom1 PASSAGE TO <u>private corridor, bedroom</u>
	2. Private bathroom2 PASSAGE TO <u>private corridor</u>
	<i>Guest bathroom PASSAGE TO circulation area</i>

Table 10 – Sequence of steps to define the ideal functional programme

A4:3 DEFINITION OF THE IDEAL ICAT PACK

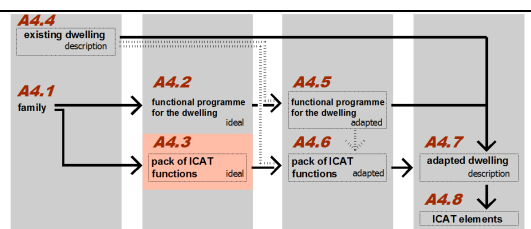

In this step the ideal ICAT pack is generated (using tables and flowcharts or automatically using computer software) as shown in the table below (Table 11) according to the family profile defined in section A4:1.

As with the ideal functional programme, the family first chooses the desired level of ICAT integration – basic, medium or optimum (Input 5). Secondly, the preliminary ideal ICAT pack is generated (Output 3). If the ICAT pack does not completely meet family needs, or if the family wishes to emphasise certain characteristics, the system allows additional technology requirements to be introduced in order of priority, using Input 6.

By combining Output 3 with Input 6 the final ideal ICAT pack is obtained – Output 4 – which will be used in the following steps of the rehabilitation process.

Input 5	Define desired quality level	<i>Basic</i>																					
Output 3	Preliminary ideal ICAT pack	<table border="1"> <tr> <td><i>Safety</i></td> <td> <table border="1"> <tr> <td><i>Detection of fire</i></td> <td> <table border="1"> <tr><td><i>Detection of smoke</i></td></tr> <tr><td><i>Detection of temperature</i></td></tr> <tr><td><i>Electrically operated valve to switch off power and gas</i></td></tr> <tr><td><i>Local alarm</i></td></tr> <tr><td><i>Remote alarm</i></td></tr> </table> </td> </tr> <tr> <td><i>Detection of gas leaks</i></td> <td> <table border="1"> <tr><td><i>Detection of gas</i></td></tr> <tr><td><i>Electrically operated valve to switch off power and gas</i></td></tr> <tr><td><i>Local alarm</i></td></tr> <tr><td><i>Remote alarm</i></td></tr> </table> </td> </tr> <tr> <td><i>Detection of flooding</i></td> <td> <table border="1"> <tr><td><i>Detection of water leak</i></td></tr> <tr><td><i>Electrically operated valve to switch off water</i></td></tr> <tr><td><i>Local alarm</i></td></tr> <tr><td><i>Remote alarm</i></td></tr> </table> </td> </tr> </table> </td> </tr> </table>	<i>Safety</i>	<table border="1"> <tr> <td><i>Detection of fire</i></td> <td> <table border="1"> <tr><td><i>Detection of smoke</i></td></tr> <tr><td><i>Detection of temperature</i></td></tr> <tr><td><i>Electrically operated valve to switch off power and gas</i></td></tr> <tr><td><i>Local alarm</i></td></tr> <tr><td><i>Remote alarm</i></td></tr> </table> </td> </tr> <tr> <td><i>Detection of gas leaks</i></td> <td> <table border="1"> <tr><td><i>Detection of gas</i></td></tr> <tr><td><i>Electrically operated valve to switch off power and gas</i></td></tr> <tr><td><i>Local alarm</i></td></tr> <tr><td><i>Remote alarm</i></td></tr> </table> </td> </tr> <tr> <td><i>Detection of flooding</i></td> <td> <table border="1"> <tr><td><i>Detection of water leak</i></td></tr> <tr><td><i>Electrically operated valve to switch off water</i></td></tr> <tr><td><i>Local alarm</i></td></tr> <tr><td><i>Remote alarm</i></td></tr> </table> </td> </tr> </table>	<i>Detection of fire</i>	<table border="1"> <tr><td><i>Detection of smoke</i></td></tr> <tr><td><i>Detection of temperature</i></td></tr> <tr><td><i>Electrically operated valve to switch off power and gas</i></td></tr> <tr><td><i>Local alarm</i></td></tr> <tr><td><i>Remote alarm</i></td></tr> </table>	<i>Detection of smoke</i>	<i>Detection of temperature</i>	<i>Electrically operated valve to switch off power and gas</i>	<i>Local alarm</i>	<i>Remote alarm</i>	<i>Detection of gas leaks</i>	<table border="1"> <tr><td><i>Detection of gas</i></td></tr> <tr><td><i>Electrically operated valve to switch off power and gas</i></td></tr> <tr><td><i>Local alarm</i></td></tr> <tr><td><i>Remote alarm</i></td></tr> </table>	<i>Detection of gas</i>	<i>Electrically operated valve to switch off power and gas</i>	<i>Local alarm</i>	<i>Remote alarm</i>	<i>Detection of flooding</i>	<table border="1"> <tr><td><i>Detection of water leak</i></td></tr> <tr><td><i>Electrically operated valve to switch off water</i></td></tr> <tr><td><i>Local alarm</i></td></tr> <tr><td><i>Remote alarm</i></td></tr> </table>	<i>Detection of water leak</i>	<i>Electrically operated valve to switch off water</i>	<i>Local alarm</i>	<i>Remote alarm</i>
<i>Safety</i>	<table border="1"> <tr> <td><i>Detection of fire</i></td> <td> <table border="1"> <tr><td><i>Detection of smoke</i></td></tr> <tr><td><i>Detection of temperature</i></td></tr> <tr><td><i>Electrically operated valve to switch off power and gas</i></td></tr> <tr><td><i>Local alarm</i></td></tr> <tr><td><i>Remote alarm</i></td></tr> </table> </td> </tr> <tr> <td><i>Detection of gas leaks</i></td> <td> <table border="1"> <tr><td><i>Detection of gas</i></td></tr> <tr><td><i>Electrically operated valve to switch off power and gas</i></td></tr> <tr><td><i>Local alarm</i></td></tr> <tr><td><i>Remote alarm</i></td></tr> </table> </td> </tr> <tr> <td><i>Detection of flooding</i></td> <td> <table border="1"> <tr><td><i>Detection of water leak</i></td></tr> <tr><td><i>Electrically operated valve to switch off water</i></td></tr> <tr><td><i>Local alarm</i></td></tr> <tr><td><i>Remote alarm</i></td></tr> </table> </td> </tr> </table>	<i>Detection of fire</i>	<table border="1"> <tr><td><i>Detection of smoke</i></td></tr> <tr><td><i>Detection of temperature</i></td></tr> <tr><td><i>Electrically operated valve to switch off power and gas</i></td></tr> <tr><td><i>Local alarm</i></td></tr> <tr><td><i>Remote alarm</i></td></tr> </table>	<i>Detection of smoke</i>	<i>Detection of temperature</i>	<i>Electrically operated valve to switch off power and gas</i>	<i>Local alarm</i>	<i>Remote alarm</i>	<i>Detection of gas leaks</i>	<table border="1"> <tr><td><i>Detection of gas</i></td></tr> <tr><td><i>Electrically operated valve to switch off power and gas</i></td></tr> <tr><td><i>Local alarm</i></td></tr> <tr><td><i>Remote alarm</i></td></tr> </table>	<i>Detection of gas</i>	<i>Electrically operated valve to switch off power and gas</i>	<i>Local alarm</i>	<i>Remote alarm</i>	<i>Detection of flooding</i>	<table border="1"> <tr><td><i>Detection of water leak</i></td></tr> <tr><td><i>Electrically operated valve to switch off water</i></td></tr> <tr><td><i>Local alarm</i></td></tr> <tr><td><i>Remote alarm</i></td></tr> </table>	<i>Detection of water leak</i>	<i>Electrically operated valve to switch off water</i>	<i>Local alarm</i>	<i>Remote alarm</i>			
<i>Detection of fire</i>	<table border="1"> <tr><td><i>Detection of smoke</i></td></tr> <tr><td><i>Detection of temperature</i></td></tr> <tr><td><i>Electrically operated valve to switch off power and gas</i></td></tr> <tr><td><i>Local alarm</i></td></tr> <tr><td><i>Remote alarm</i></td></tr> </table>	<i>Detection of smoke</i>	<i>Detection of temperature</i>	<i>Electrically operated valve to switch off power and gas</i>	<i>Local alarm</i>	<i>Remote alarm</i>																	
<i>Detection of smoke</i>																							
<i>Detection of temperature</i>																							
<i>Electrically operated valve to switch off power and gas</i>																							
<i>Local alarm</i>																							
<i>Remote alarm</i>																							
<i>Detection of gas leaks</i>	<table border="1"> <tr><td><i>Detection of gas</i></td></tr> <tr><td><i>Electrically operated valve to switch off power and gas</i></td></tr> <tr><td><i>Local alarm</i></td></tr> <tr><td><i>Remote alarm</i></td></tr> </table>	<i>Detection of gas</i>	<i>Electrically operated valve to switch off power and gas</i>	<i>Local alarm</i>	<i>Remote alarm</i>																		
<i>Detection of gas</i>																							
<i>Electrically operated valve to switch off power and gas</i>																							
<i>Local alarm</i>																							
<i>Remote alarm</i>																							
<i>Detection of flooding</i>	<table border="1"> <tr><td><i>Detection of water leak</i></td></tr> <tr><td><i>Electrically operated valve to switch off water</i></td></tr> <tr><td><i>Local alarm</i></td></tr> <tr><td><i>Remote alarm</i></td></tr> </table>	<i>Detection of water leak</i>	<i>Electrically operated valve to switch off water</i>	<i>Local alarm</i>	<i>Remote alarm</i>																		
<i>Detection of water leak</i>																							
<i>Electrically operated valve to switch off water</i>																							
<i>Local alarm</i>																							
<i>Remote alarm</i>																							

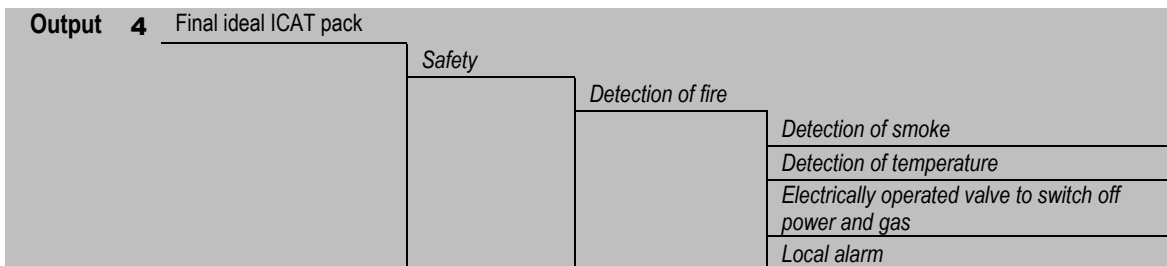
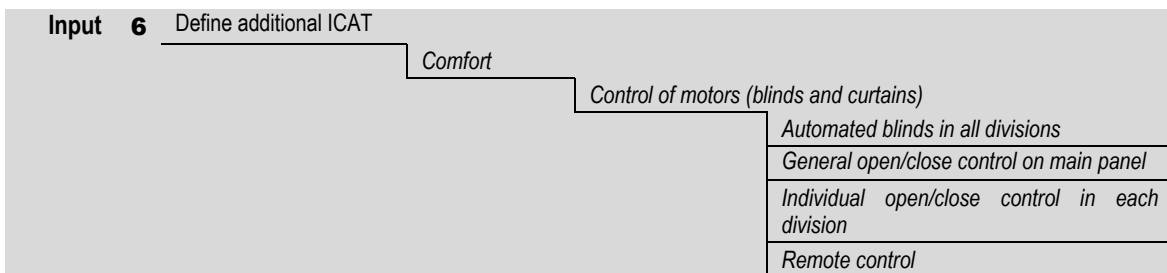
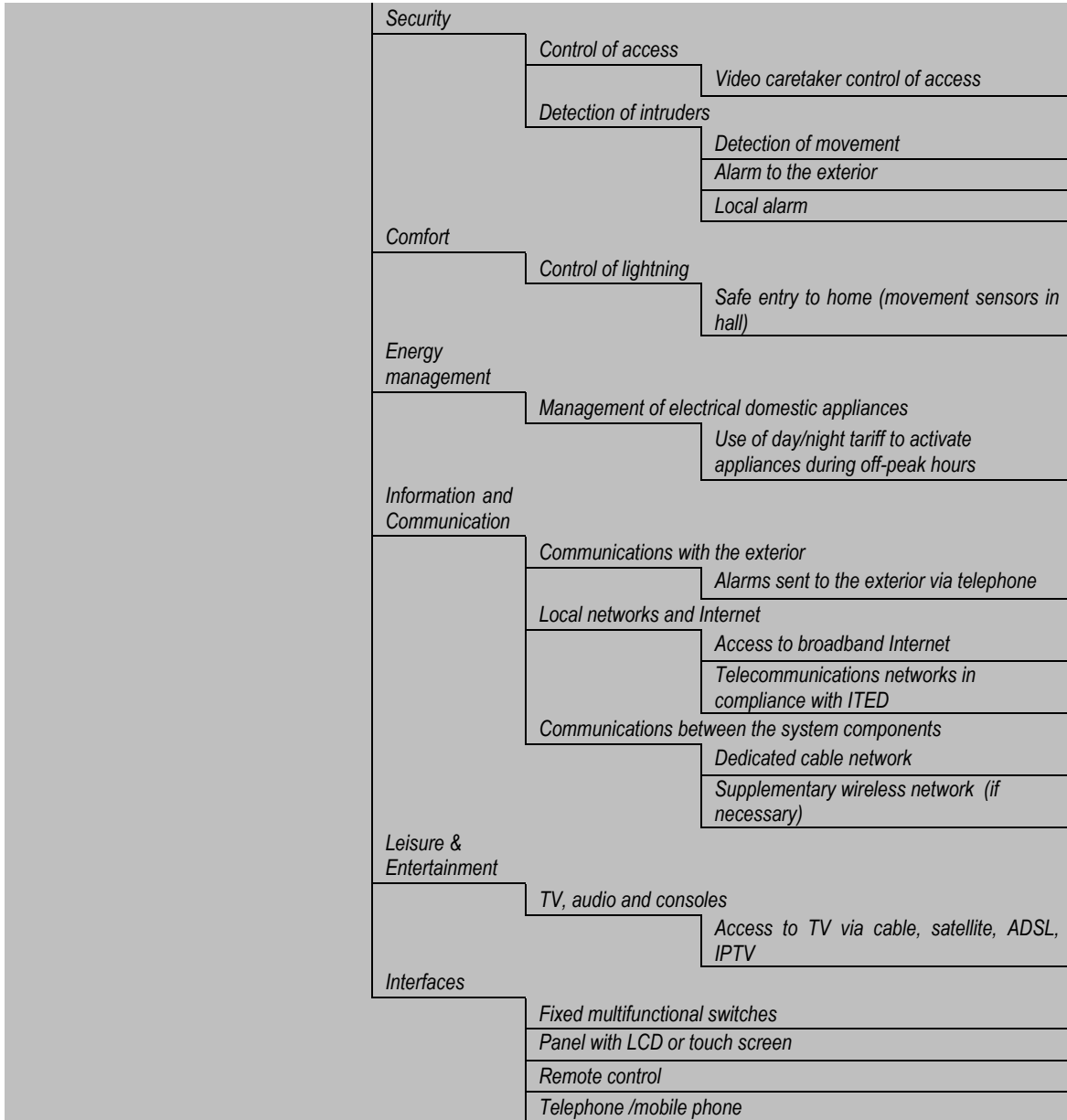

		Remote alarm
	Detection of gas leaks	
		Detection of gas
		Electrically operated valve to switch off power and gas
		Local alarm
		Remote alarm
	Detection of flooding	
		Detection of water leak
		Electrically operated valve to switch off water
		Local alarm
		Remote alarm
	Security	
	Control of access	
		Video caretaker control of access
	Detection of intruders	
		Detection of movement
		Alarm to the exterior
		Local alarm
	Comfort	
	Control of motors (blinds and curtains)	
		Automated blinds in all divisions
		General open/close control on main panel
		Individual open/close control in each division
		Remote control
	Energy management	
	Management of electrical domestic appliances	
		Use of day/night tariff to activate appliances during off-peak hours
	Information and Communication	
	Communications with the exterior	
		Alarms sent to the exterior via telephone
	Local networks and Internet	
		Access to broadband Internet
		Telecommunications networks in compliance with ITED
	Communications between the system components	
		Dedicated cable network
		Supplementary wireless network (if necessary)
	Leisure & Entertainment	
	TV, audio and consoles	
		Access to TV via cable, satellite, ADSL, IPTV
	Interfaces	
		Fixed multifunctional switches
		Panel with LCD or touch screen
		Remote control
		Telephone /mobile phone

Table 11 – Sequence of steps to define the ideal ICAT pack

A4:4 DESCRIPTION OF THE EXISTING DWELLING

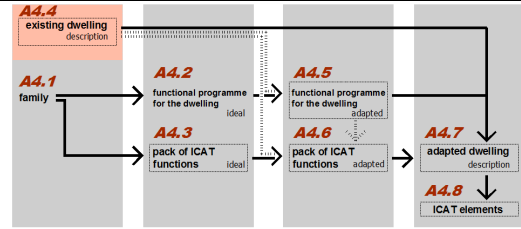

In order to define the adapted housing programme and the adapted ICAT pack in addition to the ideal functional programme (Output 2) and the ideal ICAT pack (Output 4), an existing dwelling is required.

In this step, the description of the existing dwelling is provided - Input 7 – describing the dwelling net floor area, dwelling type, number of habitable spaces, a description of each space (habitable/non habitable, isolated/demarcated/included, net floor area), and the topology (using a graph) (Table 12).

Since this description will also be used in the definition of the ideal ICAT pack, other characteristics are needed, namely the floor on which the dwelling is situated and a definition of the interior spaces that may be accessed from other buildings.

Input	7 Existing dwelling
	Net floor area 100m ²
	Type A
	Number of habitable spaces 7
	Building floor 2 ^a
	Exterior spaces that can be accessed from other buildings YES; rear balcony
	Spaces
	(hs) Habitable space / isolated / 13.3m ²
	(hs) Habitable space / isolated / 13.1m ²
	(Xki) Existing Kitchen / isolated / 8.1m ²
	(hs) Habitable space / isolated / 14.1m ²
	(hs) Habitable space / isolated / 14.1m ²
	(hs) Habitable space / isolated / 7.6m ²
	(hs) Habitable space / isolated / 6.33m ²
	(Xla) Existing Laundry / demarcated / 3.2m ²
	(Xba) Existing Bathroom / isolated / 3.4m ²
	(Xba.se) Existing service Bathroom / isolated / 1.9m ²
	(nhs) Non habitable space/ demarcated / 1.6m ²
	(nhs) Non habitable space / isolated / 2m ²
	(nhs) Non habitable space / isolated / 3.3m ²
	(nhs) Non habitable space / isolated / 4.5m ²
	(nhs) Non habitable space / isolated / 3.7m ²

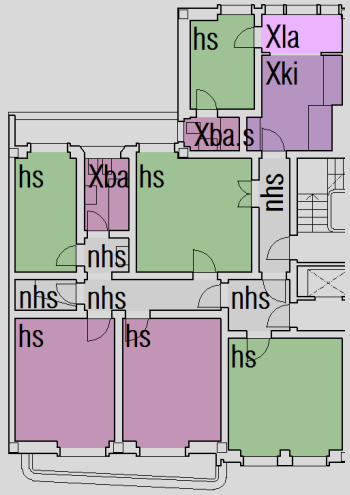

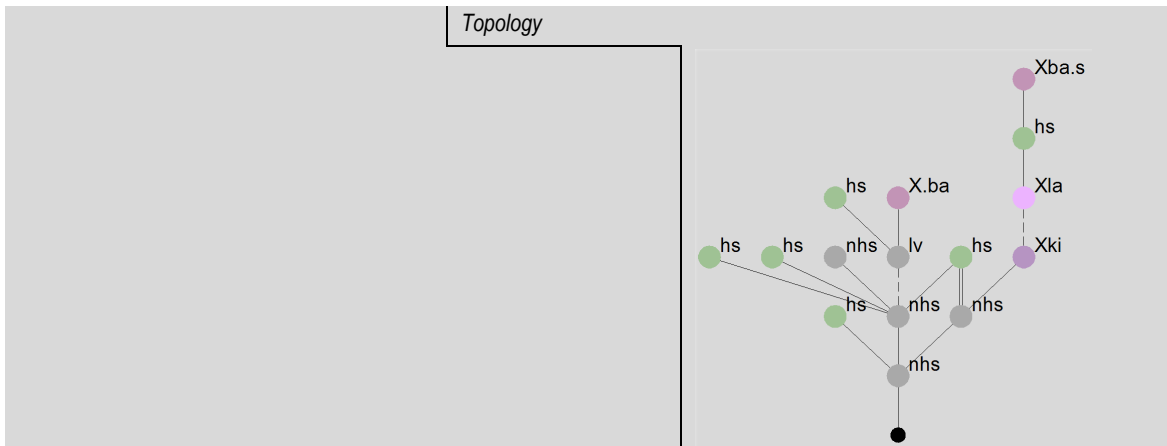
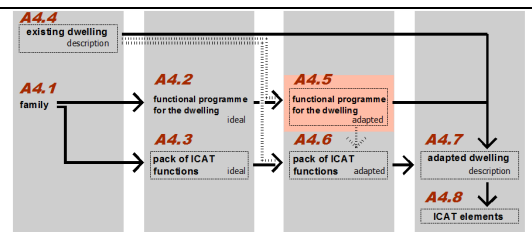

Table 12 – Sequence of steps to describe the existing dwelling

A4:5 DEFINITION OF THE ADAPTED FUNCTIONAL PROGRAMME



After defining the existing dwelling, the family is asked about the scale of building work they intend to carry out, so that a rehabilitation strategy can be chosen. This choice is the consequence of a series of decisions the family has to make, which are addressed in *Part 2: Chapter 2.3* and introduced in Input 8.

The adapted functional programme (Output 6) combines the ideal functional programme (Output 2) with the existing dwelling (Input 7) in order to create an adapted functional programme (Table 13).

The method used is:

- _ Comparison of the number of habitable spaces in both the functional programme and the existing dwelling,
- _ Comparison of the net floor area needed for each room in the functional programme and the existing net floor area.

As previously stated, this step will allow for an intermediate evaluation of the capacity of the existing dwelling to fulfil the functional programme required by the family.

Input 8	Choosing the dwelling and rehabilitation strategy	
	Does the dwelling correspond to the functional programme?	
	Area needed (94/105m ²)	→ Yes (100m ²)
	Type (A or D)	→ Yes (A)
	Rehabilitation of the whole building? → No	

Output 5		<i>Strategy</i>	2
Output 6	Adapted programme	functional	
		<i>Spaces</i>	
			<i>T3, 7 habitable spaces</i>
			<i>(hs) Double bedroom / isolated / 12m²</i>
			<i>(hs) Single bedrooms / isolated / 8.5m²</i>
			<i>(hs) Single bedrooms / isolated / 8.5m²</i>
			<i>(hs) Kitchen / isolated / <10.5m²</i>
			<i>(hs) Living room + media room / demarcated or isolated / <19m²</i>
			<i>(hs) Dining room / demarcated or isolated / 12m²</i>
			<i>(hs) Home office / isolated / 7m²</i>
			<i>Laundry / demarcated/ 3.5m²</i>
			<i>Private bathroom / isolated / 5m²</i>
			<i>Private bathroom / isolated / 3.5m²</i>
			<i>Guest bathroom / isolated / 1m²</i>
			<i>Storage areas / demarcated / <4.5m²</i>
			<i>Circulation area / demarcated/ ±16m²</i>
		<i>Priority topology</i>	
			<i>1. Bedroom1 CLOSE TO Bedroom2</i>
			<i>1. Bedroom1 CLOSE TO Bedroom3</i>
			<i>1. Bedroom2 CLOSE TO Bedroom3</i>
			<i>2. Private bathroom1 PASSAGE TO private circulation area, bedroom</i>
			<i>2. Private bathroom2 PASSAGE TO private circulation area, bedroom</i>
			<i>3. Dining room CLOSE/DOOR TO Kitchen</i>
			<i>4. Living room NEXT TO Hall</i>
			<i>Bedrooms1,2,3 PASSAGE TO private corridor</i>
			<i>Bedrooms FAR FROM Hall</i>
			<i>Bedrooms with great DEPTH</i>
			<i>Living/dining room PASSAGE TO circulation area</i>
			<i>Living room PASSAGE TO Dining room</i>
			<i>Living room CLOSE TO Guest bathroom</i>
			<i>Living/dining room DISTRIBUTEDNESS "c" or "d"</i>
			<i>Dining room CLOSE TO Hall</i>
			<i>Dining room CLOSE TO Guest bathroom</i>
			<i>Home office INCLUDED IN Living or Dining room</i>
			<i>Media room INCLUDED IN Living or dining room</i>
			<i>Kitchen PASSAGE TO Circulation area</i>
			<i>Kitchen CLOSE TO Hall</i>
			<i>Kitchen PASSAGE/CLOSE TO Dining room</i>
			<i>Kitchen CLOSE TO Guest bathroom</i>
			<i>Laundry PASSAGE TO Kitchen</i>
			<i>Guest bathroom PASSAGE TO circulation area</i>

Table 13 – Sequence of steps to define the adapted functional programme

A4:6 DEFINITION OF THE ADAPTED ICAT PACK

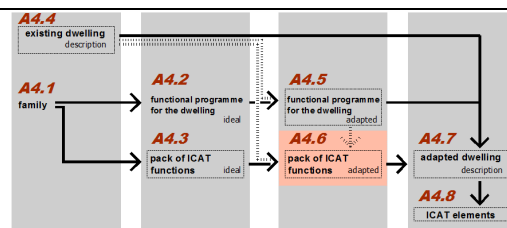

The adapted ICAT pack (Output 7) combines the ideal ICAT pack (Output 4) with the existing dwelling (Input 7) and the adapted functional programme (Output 6). The method used is:

- _ Comparison of the ICAT functions prescribed in the ideal ICAT pack and the definition of ICAT functions, by division (*Part 2: Chapter 3.2*);
- _ Comparison of the ICAT functions prescribed in the ideal ICAT pack and the final divisions prescribed by the adapted functional programme (Output 6).

This step will enable the definition of the ICAT set to be integrated into each division in the adapted functional programme for the dwelling. The sequence of steps needed to define the adapted ICAT pack is shown in the table below (Table 14).

Output 7 Adapted ICAT pack	
<i>Double bedroom</i>	
	<i>Security: IF window_to rear balcony → Detection of intruders: movement detector, alarms (local and remote)</i>
	<i>Comfort: Control of motors (blinds and curtains) – motor, wall mounted switch and remote control, central control</i>
	<i>IC: Local networks and Internet - Ethernet and broadband Internet sockets</i>
	<i>IC: Communications - wired infrastructure between the domotic appliances</i>
	<i>Leisure & Entertainment: TV via cable, satellite, ADSL or IPTV</i>
	<i>Interfaces: Wall mounted multifunction interfaces</i>
<i>2 Single bedrooms</i>	
	<i>Security: IF window to rear balcony → Detection of intruders: movement detector, alarms (local and remote)</i>
	<i>Comfort: Control of motors (blinds and curtains) – motor, wall mounted switch and remote control, central control</i>
	<i>IC: Local networks and Internet - Ethernet and broadband Internet sockets</i>
	<i>IC: Communications - wired infrastructure between the domotic appliances</i>
	<i>Leisure & Entertainment: TV via cable, satellite, ADSL or IPTV</i>
	<i>Interfaces: Wall mounted multifunction interfaces</i>
<i>Kitchen</i>	
	<i>Safety: Detection of fire - temperature detector, alarms (local and remote alarm)</i>
	<i>Safety: Detection of gas leaks - gas detector, alarms (local and remote alarm)</i>
	<i>Safety: Detection of flooding - water detector, alarms (local and remote alarm)</i>

		<p><i>Security: IF window to rear balcony → Detection of intruders: movement detector, alarms (local and remote)</i></p> <p><i>Comfort: Control of motors (blinds and curtains) – motor, wall mounted switch and remote control, central control</i></p> <p><i>Energy management: electrical domestic appliances</i></p> <p><i>IC: Local networks and Internet - Ethernet and broadband Internet sockets</i></p> <p><i>IC: Communications - wired infrastructure between the domotic appliances</i></p> <p><i>Interfaces: Wall mounted multifunction interfaces</i></p>
	<i>Living room + media room</i>	
		<p><i>Security: IF window to rear balcony → Detection of intruders: movement detector, alarms (local and remote)</i></p> <p><i>Comfort: Control of motors (blinds and curtains) – motor, wall mounted switch and remote control, central control</i></p> <p><i>IC: Local networks and Internet - Ethernet and broadband Internet sockets</i></p> <p><i>IC: Communications - wired infrastructure between the domotic appliances</i></p> <p><i>Leisure & Entertainment: TV via cable, satellite, ADSL or IPTV</i></p> <p><i>Interfaces: Wall mounted multifunction interfaces, remote control</i></p>
	<i>Dining room</i>	
		<p><i>Security: IF window to rear balcony → Detection of intruders: movement detector, alarms (local and remote)</i></p> <p><i>Comfort: Control of motors (blinds and curtains) – motor, wall mounted switch and remote control, central control</i></p> <p><i>IC: Local networks and Internet - Ethernet and broadband Internet sockets</i></p> <p><i>IC: Communications - wired infrastructure between the domotic appliances</i></p> <p><i>Interfaces: Wall mounted multifunction interfaces, remote control</i></p>
	<i>Home office</i>	
		<p><i>Security: IF window to rear balcony → Detection of intruders: movement detector, alarms (local and remote)</i></p> <p><i>Comfort: Control of motors (blinds and curtains) – motor, wall mounted switch and remote control, central control</i></p> <p><i>IC: Local networks and Internet - Ethernet and broadband Internet sockets</i></p> <p><i>IC: Communications - wired infrastructure between the domotic appliances</i></p> <p><i>Leisure & Entertainment: TV via cable, satellite, ADSL or IPTV</i></p> <p><i>Interfaces: Wall mounted multifunction interfaces, remote control</i></p>
	<i>Laundry</i>	
		<p><i>Safety: Detection of gas leaks: gas detector, alarms (local and remote alarm)</i></p>

		<p><i>Safety: Detection of flooding: water detector, alarms (local and remote alarm)</i></p> <p><i>IF window to rear balcony → Detection of intruders: movement detector, alarms (local and remote)</i></p> <p><i>Comfort: Control of motors (blinds and curtains) – motor, wall mounted switch and remote control, central control</i></p> <p><i>Energy management: electrical domestic appliances</i></p> <p><i>IC: Local networks and Internet - Ethernet and broadband Internet sockets, wired infrastructure</i></p> <p><i>Interfaces: Wall mounted multifunction interfaces</i></p>
	Private bathroom	<p><i>Safety: Detection of flooding - water detector, alarms (local and remote alarm)</i></p> <p><i>Security: IF window to rear balcony → Detection of intruders: movement detector, alarms (local and remote)</i></p> <p><i>Comfort: Control of motors (blinds and curtains) – motor, wall mounted switch and remote control, central control</i></p> <p><i>IC: Communications - wired infrastructure between the domotic appliances</i></p> <p><i>Interfaces: Wall mounted multifunction interfaces</i></p>
	Guest bathroom	<p><i>Safety: Detection of flooding - water detector, alarms (local and remote alarm)</i></p> <p><i>Security: IF window to rear balcony → Detection of intruders: movement detector, alarms (local and remote)</i></p> <p><i>Comfort: Control of motors (blinds and curtains) – motor, wall mounted switch and remote control, central control</i></p> <p><i>IC: Communications - wired infrastructure between the domotic appliances</i></p> <p><i>Interfaces: Wall mounted multifunction interfaces</i></p>
	Storage areas	
	Circulation area	
	Hall	<p><i>Safety: Detection of fire - smoke detector, alarms (local and remote alarm)</i></p> <p><i>Security: Detection of intruders - movement detector, alarms (local and remote)</i></p> <p><i>Security: Control of access - entry phone</i></p> <p><i>Comfort: Lightning controlled by movement sensor (safe entry)</i></p> <p><i>IC: Communications - wired infrastructure between the domotic appliances; communication to the exterior (e.g. alarms)</i></p> <p><i>IC: Local networks and Internet - Ethernet and broadband Internet sockets, wired infrastructure</i></p> <p><i>Interfaces: Wall mounted multifunction interfaces, touch panel, remote control</i></p>
	Corridors	<p><i>IC: Communications - wired infrastructure between the domotic appliances;</i></p> <p><i>IC: Local networks and Internet - wired infrastructure</i></p> <p><i>Interfaces: Wall mounted multifunction interfaces</i></p>

Table 14 – Sequence of steps to define the adapted ICAT pack

A4:7 DEFINITION OF THE ADAPTED DWELLING: APPLICATION OF THE TRANSFORMATION GRAMMAR

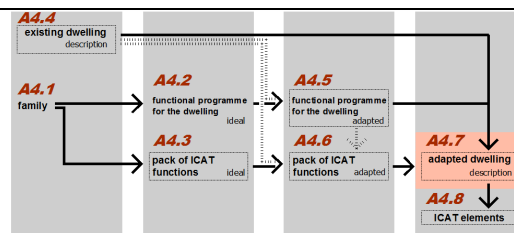

After defining both the functional programme and the ICAT pack, all the data needed to start the dwelling transformation is available. Using the data previously defined, one example is given of a possible transformation for the dwelling that fulfils the family requirements to a large extent.

The derivation example shows all the rules applied step by step in order to formulate a viable design for the given family and dwelling.

The schemes presented at the end of this Appendix are, in order of appearance:

- _ The original dwelling (floor plan and graph) and an evaluation of its space syntax;
- _ The derivation of the functional transformation of the dwelling, step by step, stating the rule applied in each step;
- _ The adapted dwelling (floor plan and graph) and an evaluation of its space syntax;
- _ An evaluation chart that details both fulfilment of family requirements and fulfilment of a set of general housing characteristics expressed in *Part 2: Chapter 2.1*. This evaluation chart was also used for each of the transformation results obtained from the experiments described in *Part 2: Chapter 1.4* and illustrated in *Appendix 2*. A comparison between the transformation hypothesis proposed in this appendix and the ones proposed during the experiments is shown in *Appendix 2*.
- _ The start of the derivation of ICAT integration for the dwelling, step by step, stating the rule applied in each step. Since not all the rules for the integration of ICAT were designed in the transformation grammar, this derivation shows only a small part of the potential for ICAT integration using shape grammar.

A4:7a Description of the derivation

As stated in *Part 2: Chapter 4.3* the description starts with a description of the initial shape – the original dwelling – and evolves as the transformation occurs, step by step. The description variables are therefore updated each time a rule is applied.

Since this task is very time consuming to perform manually it was only carried out for the first steps following the creation of a parallel representation and in the 12th step to illustrate the application of a rule that eliminates an existing wall and adds a new one.

This indicates that the description of the initial shape will be as complex as the description of the final design, since all the properties of the dwelling are already present in the design from the time the derivation begins.

To perform the description the labels indicated in *Part 2: Chapter 4.2.2* were used and a number was added to each repeated label to differentiate between different spaces with the same label (e.g. *hs1* and *hs2* instead of *hs* and *hs*) (see Figure 6).

The following tables show the description during the transformation process that occurred after the steps shown in the previous section. In each table the **bold** variables indicate what has been changed in relation to the previous table. In Table 18 the underlined variables indicate what has been changed following the application of the rule that changes the room shape.

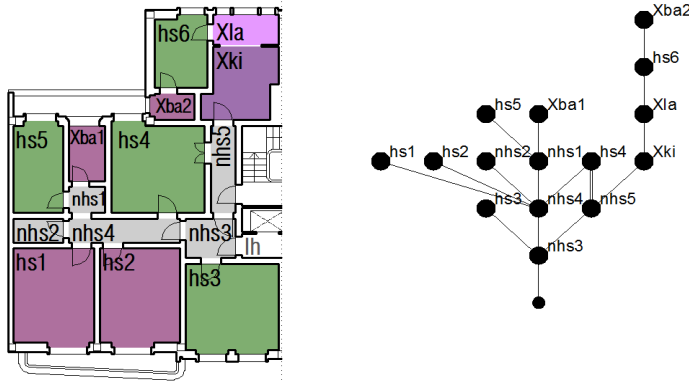

Figure 6 - Dwelling floor plan and justified graph with labels.

STEP #4 _ INSERTION OF LABELS

$\alpha_1 \leftarrow$	< A >
$\alpha_2 \leftarrow$	< [(hs1,isolated) (hs2,isolated) (hs3,isolated) (hs4,isolated) (hs5,isolated) (hs6,isolated) (nhs1,demarcated) (nhs2,isolated) (nhs3,isolated) (nhs4,isolated) (nhs5,isolated) (Xki,isolated) (Xla,demarcated) (Xba1,isolated) (Xba2,isolated)] >
$\alpha_3 \leftarrow$	< 100 >
$\alpha_4 \leftarrow$	< [(hs1, 13.3) (hs2, 13.1) (hs3, 14.1) (hs4, 14.1) (hs5, 7.6) (hs6, 6.3) (nhs1, 1.6) (nhs2, 2) (nhs3, 3.3) (nhs4, 4.45) (nhs5, 3.7) (Xki, 8.1) (Xla, 3.2) (Xba1, 3.4) (Xba2, 1.9)] >
$\alpha_5 \leftarrow$	< [(hs1,4,3.25) (hs2,4,3.2) (hs3,3.65,3.72) (hs4,3,7,3.75) (hs5, 3,7,2) (hs6, 2,9,2.1) (nhs1,1,1,1.45) (nhs2,1,2) (nhs3,1.65,2) (nhs4,1,4,45) (nhs5,3,7,1) (Xki,3,1,2.62) (Xla,1.25,2.62) (Xba,2.35,1.45) (Xba,1,1,1.3)] >
$\alpha_6 \leftarrow$	< [(hs1, nhs4, passage_to) (hs2, nhs4, passage_to) (hs3, nhs3, passage_to) (hs4, nhs4, passage_to) (hs4, nhs5, passage_to) (hs5, nhs1, passage_to) (hs6, Xla, passage_to) (hs6, Xba2, passage_to) (nhs1, Xba1, passage_to) (nhs1, nhs4, passage_to) (nhs2, nhs4, passage_to) (nhs3, nhs4, passage_to) (nhs3, nhs5, passage_to) (nhs5, Xki, passage_to) (Xki, Xla, passage_to)] [(hs1, nhs3, next_to) (hs1, nhs1, next_to) (hs1, hs4, next_to) (hs2, nhs3, next_to) (hs2, nhs1, next_to) (hs2, hs4, next_to) (nhs2, nhs3, next_to) (nhs2, nhs1, next_to) (nhs2, hs4, next_to) (hs3, nhs5, next_to) (hs4, Xki, next_to) (hs4, nhs3, next_to) (hs4, nhs2, next_to) (hs5, Xba1, next_to) (hs5, nhs4, next_to) (hs6, Xki, next_to) (nhs1, nhs3, next_to) (nhs1, nhs2, next_to) (nhs3, Xki, next_to) (nhs3, nhs2, next_to) (nhs4, Xba1, next_to) (nhs4, nhs5, next_to) (nhs5, Xla, next_to) (Xla, Xba2, next_to)] [(hs1, hs3, close_to) (hs1, hs5, close_to) (hs1, Xba1, close_to) (hs1, nhs5, close_to) (hs2, hs3, close_to) (hs2, hs5, close_to) (hs2, Xba1, close_to) (hs2, nhs5, close_to) (hs3, nhs2, close_to) (hs3, nhs1, close_to) (hs3, hs4, close_to) (hs3, Xki, close_to) (hs4, nhs2, close_to) (hs4, nhs1, close_to) (hs4, Xla, close_to) (hs5, nhs2, close_to) (hs5, nhs3, close_to) (nhs1, nhs5, close_to) (nhs2, Xba1, close_to) (nhs2, nhs5, close_to) (nhs3, Xba1, close_to) (nhs3, Xla, close_to) (nhs4, Xki, close_to) (nhs5, hs6, close_to) (Xki, Xba2, close_to)] [(hs1, Xki, far_from) (hs1, Xla, far_from) (hs1, hs6, far_from) (hs1, Xba2, far_from) (hs2, Xki, far_from) (hs2, Xla, far_from) (hs2, hs6, far_from) (hs2, Xba2, far_from) (nhs1, Xki, far_from) (nhs1, Xla, far_from) (nhs1, hs6, far_from) (nhs1, Xba2, far_from) (nhs2, Xki, far_from) (nhs2, Xla, far_from) (nhs2, hs6, far_from) (nhs2, Xba2, far_from) (hs4, hs6, far_from) (hs4, Xba2, far_from) (hs3, Xla, far_from) (hs3, hs6, far_from) (hs3, Xba2, far_from) (hs5, nhs5, far_from) (hs5, Xki, far_from) (hs5, Xla, far_from) (hs5, hs6, far_from) (hs5, Xba2, far_from) (hs6, Xba1, far_from) (hs6, nhs4, far_from) (hs6, nhs3, far_from) (nhs3, Xba2, far_from) (nhs4, Xla, far_from) (nhs4, Xba2, far_from) (nhs5, Xba1, far_from) (nhs5, Xba2, far_from) (Xba1, Xba2, far_from) (Xba1, Xla, far_from) (Xba1, Xki, far_from)] >

$\alpha_7 \leftarrow$	< [(hs1, hs2, adjacent) (hs1, nhs2, adjacent) (hs1, nhs4, adjacent) (hs2, nhs4, adjacent) (hs2, hs3, adjacent) (hs3, nhs3, adjacent) (hs4, Xba1, adjacent) (hs4, nhs1, adjacent) (hs4, nhs4, adjacent) (hs4, nhs5, adjacent) (hs4, Xba2, adjacent) (hs5, Xba1, adjacent) (hs5, nhs2, adjacent) (hs5, nhs1, adjacent) (hs6 Xba2, adjacent) (hs6, Xki, adjacent) (hs6, Xla, adjacent) (nhs1, Xba1, adjacent) (nhs1, nhs4, adjacent) (nhs2, nhs4, adjacent) (nhs3, nhs4, adjacent) (nhs3, nhs5, adjacent) (nhs5, Xki, adjacent) (Xba2, Xki, adjacent) (Xki, Xla, adjacent)] >
$\alpha_8 \leftarrow$	< (f, us) (b, us) (p, us) (s, usi) >
$\alpha_9 \leftarrow$	< [(w _{ub} (hs1, hs2, 4)) (w _{ub} (hs1, nhs2, 2)) (w _{ub} (hs1, nhs4, 1)) (w _{ub} (hs2, nhs4, 3.2)) (w _{ub} (hs2, hs3, 4)) (w _{ub} (hs3, nhs3, 2)) (w _{ub} (hs4, Xba1, 2.35)) (w _{ub} (hs4, nhs1, 1.1)) (w _{ub} (hs4, nhs4, 2.75)) (w _{ub} (hs4, nhs5, 3.7)) (w _{ub} (hs4, Xba2, 1.6)) (w _{ub} (hs5, Xba1, 3.7)) (w _{ub} (hs5, nhs2, 2)) (w _{ub} (hs5, nhs1, 1.1)) (w _{ub} (hs6, Xba2, 1.6)) (w _{ub} (hs6, Xki, 1.75)) (w _{ub} (hs6, Xla, 1.05)) (w _{ub} (nhs1, Xba1, 1.45)) (w _{ub} (nhs1, nhs4, 1.45)) (w _{ub} (nhs2, nhs4, 1)) (w _{ub} (nhs3, nhs4, 1)) (w _{ub} (nhs3, nhs5, 1)) (w _{ub} (nhs5, Xki, 1)) (w _{ub} (Xba2, Xki, 1.1)) (w _{ub} (Xki, Xla, 2.65))] >
$\alpha_{10} \leftarrow$	< S-1 >

Table 15 – Step #4 of the derivation

STEP #5 _ ASSIGNMENT OF ISOLATED KITCHEN

$\alpha_1 \leftarrow$	< A >
$\alpha_2 \leftarrow$	< [(hs ₁ ,isolated) (hs ₂ ,isolated) (hs ₃ ,isolated) (hs ₄ ,isolated) (hs ₅ ,isolated) (hs ₆ ,isolated) (nhs ₁ ,demarcated) (nhs ₂ ,isolated) (nhs ₃ ,isolated) (nhs ₄ ,isolated) (nhs ₅ ,isolated) (ki,isolated) (Xla,demarcated) (Xba ₁ ,isolated) (Xba ₂ ,isolated)] >
$\alpha_3 \leftarrow$	< 100 >
$\alpha_4 \leftarrow$	< [(hs1, 13.3) (hs2, 13.1) (hs3, 14.1) (hs4, 14.1) (hs5, 7.6) (hs6, 6.3) (nhs1, 1.6) (nhs2, 2) (nhs3, 3.3) (nhs4, 4.45) (nhs5, 3.7) (ki, 8.1) (Xla, 3.2) (Xba1, 3.4) (Xba2, 1.9)] >
$\alpha_5 \leftarrow$	< [(hs1,4,3.25) (hs2,4,3.2) (hs3,3.65,3.72) (hs4,3.7,3.75) (hs5, 3.7,2) (hs6, 2.9,2.1) (nhs1,1.1,1.45) (nhs2,1,2) (nhs3,1.65,2) (nhs4,1,4.45) (nhs5,3.7,1) (ki,3.1,2.62) (Xla,1.25,2.62) (Xba,2.35,1.45) (Xba,1.1,1.3)] >
$\alpha_6 \leftarrow$	< [(hs1, nhs4, passage_to) (hs2, nhs4, passage_to) (hs3, nhs3, passage_to) (hs4, nhs4, passage_to) (hs4, nhs5, passage_to) (hs5, nhs1, passage_to) (hs6, Xla, passage_to) (hs6, Xba2, passage_to) (nhs1, Xba1, passage_to) (nhs1, nhs4, passage_to) (nhs2, nhs4, passage_to) (nhs3, nhs4, passage_to) (nhs3, nhs5, passage_to) (nhs5, ki, passage_to) (Xki, Xla, passage_to)] [(hs1, nhs3, next_to) (hs1, nhs1, next_to) (hs1, hs4, next_to) (hs2, nhs3, next_to) (hs2, nhs1, next_to) (hs2, hs4, next_to) (nhs2, nhs3, next_to) (nhs2, nhs1, next_to) (nhs2, hs4, next_to) (hs3, nhs5, next_to) (hs4, ki, next_to) (hs4, nhs3, next_to) (hs4, nhs2, next_to) (hs5, Xba1, next_to) (hs5, nhs4, next_to) (hs6, ki, next_to) (nhs1, nhs3, next_to) (nhs1, nhs2, next_to) (nhs3, ki, next_to) (nhs3, nhs2, next_to) (nhs4, Xba1, next_to) (nhs4, nhs5, next_to) (nhs5, Xla, next_to) (Xla, Xba2, next_to)] [(hs1, hs3, close_to) (hs1, hs5, close_to) (hs1, Xba1, close_to) (hs1, nhs5, close_to) (hs2, hs3, close_to) (hs2, hs5, close_to) (hs2, Xba1, close_to) (hs2, nhs5, close_to) (hs3, nhs2, close_to) (hs3, nhs1, close_to) (hs3, hs4, close_to) (hs3, ki, close_to) (hs4, nhs2, close_to) (hs4, nhs1, close_to) (hs4, Xla, close_to) (hs5, nhs2, close_to) (hs5, nhs3, close_to) (nhs1, nhs5, close_to) (nhs2, Xba1, close_to) (nhs2, nhs5, close_to) (nhs3, Xba1, close_to) (nhs3, Xla, close_to) (nhs4, ki, close_to) (nhs5, hs6, close_to) (Ki, Xba2, close_to)] [(hs1, ki, far_from) (hs1, Xla, far_from) (hs1, hs6, far_from) (hs1, Xba2, far_from) (hs2, ki, far_from) (hs2, Xla, far_from) (hs2, hs6, far_from) (hs2, Xba2, far_from) (nhs1, ki, far_from) (nhs1, Xla, far_from) (nhs1, hs6, far_from) (nhs1, Xba2, far_from) (nhs2, ki, far_from) (nhs2, Xla, far_from) (nhs2, hs6, far_from) (nhs2, Xba2, far_from) (hs4, hs6, far_from) (hs4, Xba2, far_from) (hs3, Xla, far_from) (hs3, hs6, far_from) (hs3, Xba2, far_from) (hs5, nhs5, far_from) (hs5, ki, far_from) (hs5, Xla, far_from) (hs5, hs6, far_from) (hs5, Xba2, far_from) (hs6, Xba1, far_from) (hs6, nhs4, far_from) (hs6, nhs3, far_from) (nhs3, Xba2, far_from) (nhs4, Xla, far_from) (nhs4, Xba2, far_from) (nhs5, Xba1, far_from) (nhs5, Xba2, far_from) (Xba1, Xba2, far_from) (Xba1, Xla, far_from) (Xba1, ki, far_from)] >
$\alpha_7 \leftarrow$	< [(hs1, hs2, adjacent) (hs1, nhs2, adjacent) (hs1, nhs4, adjacent) (hs2, nhs4, adjacent) (hs2, hs3, adjacent) (hs3, nhs3, adjacent) (hs4, Xba1, adjacent) (hs4, nhs1, adjacent) (hs4, nhs4, adjacent) (hs4, nhs5, adjacent) (hs4,

	Xba2, adjacent) (hs5, Xba1, adjacent) (hs5, nhs2, adjacent) (hs5, nhs1, adjacent) (hs6 Xba2, adjacent) (hs6, ki, adjacent) (hs6, Xla, adjacent) (nhs1, Xba1, adjacent) (nhs1, nhs4, adjacent) (nhs2, nhs4, adjacent) (nhs3, nhs4, adjacent) (nhs3, nhs5, adjacent) (nhs5, ki, adjacent) (Xba2, ki, adjacent) (ki, Xla, adjacent)]>
$\alpha 8 \leftarrow$	< (f, us) (b, us) (p, us) (s, usi) >
$\alpha 9 \leftarrow$	< [(w _{ub} (hs1, hs2, 4)) (w _{ub} (hs1, nhs2, 2)) (w _{ub} (hs1, nhs4, 1)) (w _{ub} (hs2, nhs4, 3.2)) (w _{ub} (hs2, hs3, 4)) (w _{ub} (hs3, nhs3, 2)) (w _{ub} (hs4, Xba1, 2.35)) (w _{ub} (hs4, nhs1, 1.1)) (w _{ub} (hs4, nhs4, 2.75)) (w _{ub} (hs4, nhs5, 3.7)) (w _{ub} (hs4, Xba2, 1.6)) (w _{ub} (hs5, Xba1, 3.7)) (w _{ub} (hs5, nhs2, 2)) (w _{ub} (hs5, nhs1, 1.1)) (w _{ub} (hs6, Xba2, 1.6)) (w_{ub} (hs6, ki, 1.75)) (w _{ub} (hs6, Xla, 1.05)) (w _{ub} (nhs1, Xba1, 1.45)) (w _{ub} (nhs1, nhs4, 1.45)) (w _{ub} (nhs2, nhs4, 1)) (w _{ub} (nhs3, nhs4, 1)) (w _{ub} (nhs3, nhs5, 1)) (w_{ub} (nhs5, ki, 1)) (w_{ub} (Xba2, ki, 1.1)) (w_{ub} (ki, Xla, 2.65))] >
$\alpha 10 \leftarrow$	< S0 >

Table 16 – Step #5 of the derivation

STEP #6 _ ASSIGNMENT OF THE HALL

$\alpha 1 \leftarrow$	< A >
$\alpha 2 \leftarrow$	< [(hs1,isolated) (hs2,isolated) (hs3,isolated) (hs4,isolated) (hs5,isolated) (hs6,isolated) (nhs1,demarcated) (nhs2,isolated) (hl,isolated) (nhs4,isolated) (nhs5,isolated) (ki,isolated) (Xla,demarcated) (Xba1,isolated) (Xba2,isolated)] >
$\alpha 3 \leftarrow$	< 100 >
$\alpha 4 \leftarrow$	< [(hs1, 13.3) (hs2, 13.1) (hs3, 14.1) (hs4, 14.1) (hs5, 7.6) (hs6, 6.3) (nhs1, 1.6) (nhs2, 2) (hl, 3.3) (nhs4, 4.45) (nhs5, 3.7) (ki, 8.1) (Xla, 3.2) (Xba1, 3.4) (Xba2, 1.9)] >
$\alpha 5 \leftarrow$	< [(hs1,4,3.25) (hs2,4,3.2) (hs3,3.65,3.72) (hs4,3.7,3.75) (hs5, 3.7,2) (hs6, 2.9,2.1) (nhs1,1.1,1.45) (nhs2,1,2) (hl,1.65,2) (nhs4,1,4.45) (nhs5,3.7,1) (ki,3.1,2.62) (Xla,1.25,2.62) (Xba,2.35,1.45) (Xba,1.1,1.3)] >
$\alpha 6 \leftarrow$	< [(hs1, nhs4, passage_to) (hs2, nhs4, passage_to) (hs3, hl, passage_to) (hs4, nhs4, passage_to) (hs4, nhs5, passage_to) (hs5, nhs1, passage_to) (hs6, Xla, passage_to) (hs6, Xba2, passage_to) (nhs1, Xba1, passage_to) (nhs1, nhs4, passage_to) (nhs2, nhs4, passage_to) (hl, nhs4, passage_to) (hl, nhs5, passage_to) (nhs5, ki, passage_to) (Xki, Xla, passage_to)] [(hs1, hl, next_to) (hs1, nhs1, next_to) (hs1, hs4, next_to) (hs2, hl, next_to) (hs2, nhs1, next_to) (hs2, hs4, next_to) (nhs2, hl, next_to) (nhs2, nhs1, next_to) (nhs2, hs4, next_to) (hs3, nhs5, next_to) (hs4, ki, next_to) (hs4, hl, next_to) (hs4, nhs2, next_to) (hs5, Xba1, next_to) (hs5, nhs4, next_to) (hs6, ki, next_to) (nhs1, hl, next_to) (nhs1, nhs2, next_to) (hl, ki, next_to) (hl, nhs2, next_to) (nhs4, Xba1, next_to) (nhs4, nhs5, next_to) (nhs5, Xla, next_to) (Xla, Xba2, next_to)] [(hs1, hs3, close_to) (hs1, hs5, close_to) (hs1, Xba1, close_to) (hs1, nhs5, close_to) (hs2, hs3, close_to) (hs2, hs5, close_to) (hs2, Xba1, close_to) (hs2, nhs5, close_to) (hs3, nhs2, close_to) (hs3, nhs1, close_to) (hs3, hs4, close_to) (hs3, ki, close_to) (hs4, nhs2, close_to) (hs4, nhs1, close_to) (hs4, Xla, close_to) (hs5, nhs2, close_to) (hs5, hl, close_to) (nhs1, nhs5, close_to) (nhs2, Xba1, close_to) (nhs2, nhs5, close_to) (hl, Xba1, close_to) (hl, Xla, close_to) (nhs4, ki, close_to) (nhs5, hs6, close_to) (Ki, Xba2, close_to)] [(hs1, ki, far_from) (hs1, Xla, far_from) (hs1, hs6, far_from) (hs1, Xba2, far_from) (hs2, ki, far_from) (hs2, Xla, far_from) (hs2, hs6, far_from) (hs2, Xba2, far_from) (nhs1, ki, far_from) (nhs1, Xla, far_from) (nhs1, hs6, far_from) (nhs1, Xba2, far_from) (nhs2, ki, far_from) (nhs2, Xla, far_from) (nhs2, hs6, far_from) (nhs2, Xba2, far_from) (hs4, hs6, far_from) (hs4, Xba2, far_from) (hs3, Xla, far_from) (hs3, hs6, far_from) (hs3, Xba2, far_from) (hs5, nhs5, far_from) (hs5, ki, far_from) (hs5, Xla, far_from) (hs5, hs6, far_from) (hs5, Xba2, far_from) (hs6, Xba1, far_from) (hs6, nhs4, far_from) (hs6, hl, far_from) (hl, Xba2, far_from) (nhs4, Xla, far_from) (nhs4, Xba2, far_from) (nhs5, Xba1, far_from) (nhs5, Xba2, far_from) (Xba1, Xba2, far_from) (Xba1, Xla, far_from) (Xba1, ki, far_from)] >
$\alpha 7 \leftarrow$	< [(hs1, hs2, adjacent) (hs1, nhs2, adjacent) (hs1, nhs4, adjacent) (hs2, nhs4, adjacent) (hs2, hs3, adjacent) (hs3, hl, adjacent) (hs4, Xba1, adjacent) (hs4, nhs1, adjacent) (hs4, nhs4, adjacent) (hs4, nhs5, adjacent) (hs4, Xba2, adjacent) (hs5, Xba1, adjacent) (hs5, nhs2, adjacent) (hs5, nhs1, adjacent) (hs6 Xba2, adjacent) (hs6, ki, adjacent) (hs6, Xla, adjacent) (nhs1, Xba1, adjacent) (nhs1, nhs4, adjacent) (nhs2, nhs4, adjacent) (hl, nhs4, adjacent) (hl, nhs5, adjacent) (nhs5, ki, adjacent) (Xba2, ki, adjacent) (ki, Xla, adjacent)]>

$\alpha 8 \leftarrow$	< (f, us) (b, us) (p, us) (s, usi) >
$\alpha 9 \leftarrow$	< [(w _{ub} (hs1, hs2, 4)) (w _{ub} (hs1, nhs2, 2)) (w _{ub} (hs1, nhs4, 1)) (w _{ub} (hs2, nhs4, 3.2)) (w _{ub} (hs2, hs3, 4)) (w_{ub}(hs3, hl, 2)) (w _{ub} (hs4, Xba1, 2.35)) (w _{ub} (hs4, nhs1, 1.1)) (w _{ub} (hs4, nhs4, 2.75)) (w _{ub} (hs4, nhs5, 3.7)) (w _{ub} (hs4, Xba2, 1.6)) (w _{ub} (hs5, Xba1, 3.7)) (w _{ub} (hs5, nhs2, 2)) (w _{ub} (hs5, nhs1, 1.1)) (w _{ub} (hs6, Xba2, 1.6)) (w _{ub} (hs6, ki, 1.75)) (w _{ub} (hs6, Xla, 1.05)) (w _{ub} (nhs1, Xba1, 1.45)) (w _{ub} (nhs1, nhs4, 1.45)) (w _{ub} (nhs2, nhs4, 1)) (w_{ub}(hl, nhs4, 1)) (w_{ub}(hl, nhs5, 1)) (w _{ub} (nhs5, ki, 1)) (w _{ub} (Xba2, ki, 1.1)) (w _{ub} (ki, Xla, 2.65))] >
$\alpha 10 \leftarrow$	< S1 >

Table 17 – Step #6 of the derivation

STEP #12 _ CHANGING THE DIMENSIONS OF A ROOM (ENLARGING OR REDUCING) BY "MOVING" A WALL (ELIMINATING AND ADDING A WALL)

$\alpha 1 \leftarrow$	< A >
$\alpha 2 \leftarrow$	< [(be.d,isolated) (be.s,isolated) (hs _{3,isolated}) (hs _{4,isolated}) (be.s,isolated) (hs _{6,isolated}) (nhs _{1,demarcated}) (ba.p,isolated) (hl,isolated) (nhs _{4,isolated}) (nhs _{5,isolated}) (ki,isolated) (Xla,demarcated) (ba.p,isolated) (Xba _{2,isolated})] >
$\alpha 3 \leftarrow$	< 100 >
$\alpha 4 \leftarrow$	< [(be.d, 11) (be.s, 13.1) (hs _{3, 14.1}) (hs _{4, 14.1}) (be.s, 7.6) (hs _{6, 6.3}) (nhs _{1, 1.6}) (ba.p, 4) (hl, 3.3) (nhs _{4, 4.45}) (nhs _{5, 3.7}) (ki, 8.1) (Xla, 3.2) (ba.p, 3.4) (Xba _{2, 1.9})] >
$\alpha 5 \leftarrow$	< [(be.d,3,3,25) (be.s,4,3,2) (hs _{3,3.65,3.72}) (hs _{4,3.7,3.75}) (be.s,3,7,2) (hs _{6,2.9,2.1}) (nhs _{1,1.1,1.45}) (ba.p,2,2) (hl,1.65,2) (nhs _{4,1.4.45}) (nhs _{5,3.7,1}) (ki,3.1,2.62) (Xla,1.25,2.62) (ba.p,2,35,1.45) (Xba,1.1,1.3)] >
$\alpha 6 \leftarrow$	< [(be.d, nhs4, passage_to) (be.s, nhs4, passage_to) (hs _{3, hl, passage_to}) (hs _{4, nhs4, passage_to}) (hs _{4, nhs5, passage_to}) (be.s, nhs1, passage_to) (hs _{6, Xla, passage_to}) (hs _{6, Xba2, passage_to}) (nhs1, ba.p, passage_to) (nhs _{1, nhs4, passage_to}) (ba.p, nhs4, passage_to) (hl, nhs4, passage_to) (hl, nhs5, passage_to) (nhs5, ki, passage_to) (Xki, Xla, passage_to)] [(be.d, hl, next_to) (be.d, nhs1, next_to) (be.d, hs4, next_to) (be.s, hl, next_to) (be.s, nhs1, next_to) (be.s, hs4, next_to) (ba.p, hl, next_to) (ba.p, nhs1, next_to) (ba.p, hs4, next_to) (hs _{3, nhs5, next_to}) (hs _{4, ki, next_to}) (hs _{4, hl, next_to}) (hs4, ba.p, next_to) (be.s, ba.p, next_to) (be.s, nhs4, next_to) (hs _{6, ki, next_to}) (nhs _{1, hl, next_to}) (nhs1, ba.p, next_to) (hl, ki, next_to) (hl, ba.p, next_to) (nhs4, ba.p, next_to) (nhs _{4, nhs5, next_to}) (nhs _{5, Xla, next_to}) (Xla, Xba _{2, next_to})] [(be.d, hs3, close_to) (be.d, be.s, close_to) (be.d, ba.p, close_to) (be.d, nhs5, close_to) (be.s, hs3, close_to) (be.s, be.s, close_to) (be.s, ba.p, close_to) (be.s, nhs5, close_to) (hs _{3, ba.p, close_to}) (hs _{3, nhs1, close_to}) (hs _{3, hs4, close_to}) (hs _{3, ki, close_to}) (hs4, ba.p, close_to) (hs _{4, nhs1, close_to}) (hs _{4, Xla, close_to}) (be.s, ba.p, close_to) (be.s, hl, close_to) (nhs _{1, nhs5, close_to}) (ba.p, ba.p, close_to) (ba.p, nhs5, close_to) (hl, ba.p, close_to) (hl, Xla, close_to) (nhs _{4, ki, close_to}) (nhs _{5, hs6, close_to}) (Ki, Xba _{2, close_to})] [(be.d, ki, far_from) (be.d, Xla, far_from) (be.d, hs6, far_from) (be.d, Xba2, far_from) (be.s, ki, far_from) (be.s, Xla, far_from) (be.s, hs6, far_from) (be.s, Xba2, far_from) (nhs _{1, ki, far_from}) (nhs _{1, Xla, far_from}) (nhs _{1, hs6, far_from}) (nhs _{1, Xba2, far_from}) (ba.p, ki, far_from) (ba.p, Xla, far_from) (ba.p, hs6, far_from) (ba.p, Xba2, far_from) (hs _{4, hs6, far_from}) (hs _{4, Xba2, far_from}) (hs _{3, Xla, far_from}) (hs _{3, hs6, far_from}) (hs _{3, Xba2, far_from}) (be.s, nhs5, far_from) (be.s, ki, far_from) (be.s, Xla, far_from) (be.s, hs6, far_from) (be.s, Xba2, far_from) (hs _{6, ba.p, far_from}) (hs _{6, nhs4, far_from}) (hs _{6, hl, far_from}) (hl, Xba _{2, far_from}) (nhs _{4, Xla, far_from}) (nhs _{4, Xba2, far_from}) (nhs5, ba.p, far_from) (nhs _{5, Xba2, far_from}) (Xba _{1, Xba2, far_from}) (Xba _{1, Xla, far_from}) (Xba _{1, ki, far_from})] >
$\alpha 7 \leftarrow$	< [(be.d, be.s, adjacent) (be.d, ba.p, adjacent) (be.d, nhs4, adjacent) (be.s, nhs4, adjacent) (be.s, hs3, adjacent) (hs _{3, hl, adjacent}) (hs4, ba.p, adjacent) (hs _{4, nhs1, adjacent}) (hs _{4, nhs4, adjacent}) (hs _{4, nhs5, adjacent}) (hs _{4, Xba2, adjacent}) (be.s, ba.p, adjacent) (be.s, ba.p, adjacent) (be.s, nhs1, adjacent) (hs _{6, Xba2, adjacent}) (hs _{6, ki, adjacent}) (hs _{6, Xla, adjacent}) (nhs1, ba.p, adjacent) (nhs _{1, nhs4, adjacent}) (ba.p, nhs4, adjacent) (hl, nhs4, adjacent) (hl, nhs5, adjacent) (nhs5, ki, adjacent) (Xba _{2, ki,}

	adjacent) (ki, Xla, adjacent)]>
$\alpha 8 \leftarrow$	< (f, us) (b, us) (p, us) (s, usi) >
$\alpha 9 \leftarrow$	< [(w _{ub} (be.d, be.s, 4)) (w _{ub} (be.d, ba.p, 2+0.75)) (w _{ub} (be.d, nhs4,1)) (w _{ub} (be.s, nhs4, 3.2)) (w _{ub} (be.s, hs3, 4)) (w _{ub} (hs3, hl, 2)) (w _{ub} (hs4, ba.p, 2.35)) (w _{ub} (hs4, nhs1, 1.1)) (w _{ub} (hs4, nhs4, 2.75)) (w _{ub} (hs4, nhs5, 3.7)) (w _{ub} (hs4, Xba2, 1.6)) (w _{ub} (be.s, ba.p, 3.7)) (w _{ub} (be.s, ba.p, 2)) (w _{ub} (be.s, nhs1, 1.1)) (w _{ub} (hs6, Xba2, 1.6)) (w _{ub} (hs6, ki, 1.75)) (w _{ub} (hs6, Xla, 1.05)) (w _{ub} (nhs1, ba.p, 1.45)) (w _{ub} (nhs1, nhs4, 1.45)) (w _{ub} (ba.p, nhs4, 1)) (w _{ub} (hl, nhs4, 1)) (w _{ub} (hl, nhs5, 1)) (w _{ub} (nhs5, ki, 1)) (w _{ub} (Xba2, ki, 1.1)) (w _{ub} (ki, Xla, 2.65))] >
$\alpha 10 \leftarrow$	< S7 >

Table 18 – Step #10 of the derivation

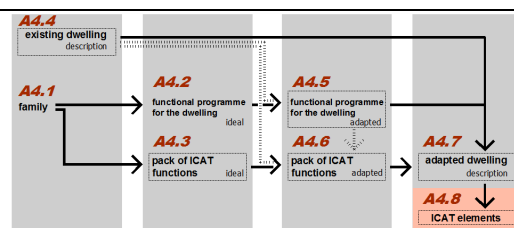
A4:8 DEFINITION OF THE ICAT ELEMENTS

The following table (Table 19) shows the list of ICAT elements (Output 8) that are needed for the proposed dwelling layout.

After defining the adapted ICAT pack functions, the grammar described in *Part 2: Chapter 4.4* proposes a method of integrating these functions and ICAT elements into the new dwelling layout after the functional transformation has been processed. In this part of the grammar the focus is on adding technologies to the dwelling and not transforming. Thus the process of ICAT integration uses shape grammar rules that are applied after the transformation grammar and that will enable each of the technologies required to be introduced step by step. As previously stated, this part of the grammar is not developed to its full extend and the final layout with the prescribed ICAT is therefore simulated in Appendix 4, omitting some steps that were not developed.

The final layout with all the domotic elements represents the following:

- The position of sensors (movement, water, gas, smoke and temperature);
- The position of motors for the controlled blinds;
- The position of controlled sockets;
- The position of multifunctional switches, entry modules and control panels;
- The position of the controlled lights;
- The position of the bus cable;
- The domotic controls (connection between the controlled device and switch that controls it);

The electrical circuits, electrical components (lighting, electrical domestic appliances, television, etc) and connections between non-automated lighting and the control panels are not represented.

Output 8	
<i>Double bedroom (be.d)</i>	
	<i>Motor for blinds</i>
	<i>Wall mounted multifunctional switch near the door (controlling automated blinds and lights) / 2 entry module to be embedded in wall (1 for blinds and the other for backup)</i>
	<i>Remote control (for blinds)</i>
	<i>Ethernet and broadband Internet sockets</i>
	<i>TV via cable, satellite, ADSL or IPTV sockets</i>
	<i>Bus Cable</i>
<i>Single bedroom (be.s1)</i>	
	<i>Movement detector near the door facing the window</i>
	<i>Motor for blinds</i>
	<i>Wall mounted multifunctional switch near the door (controlling automated blinds and lights) / 2 entry module to be embedded in wall (1 for blinds and the other for backup)</i>
	<i>Remote control (control for blinds)</i>
	<i>Ethernet and broadband Internet sockets</i>
	<i>TV via cable, satellite, ADSL or IPTV sockets</i>
	<i>Bus Cable</i>
<i>Single bedroom (be.s2)</i>	
	<i>Motor for blinds</i>
	<i>Wall mounted multifunctional switch near the door (controlling automated blinds and lights) / 2 entry module to be embedded in wall (1 for blinds and the other for backup)</i>
	<i>Remote control (control for blinds)</i>
	<i>Ethernet and broadband Internet sockets</i>
	<i>TV via cable, satellite, ADSL or IPTV sockets</i>
	<i>Bus Cable</i>
<i>Kitchen (ki)</i>	
	<i>Temperature detector</i>
	<i>Gas detector</i>
	<i>Water detector</i>
	<i>Motor for blinds</i>
	<i>Wall mounted multifunctional switch near the door (controlling automated blinds and lights) / 2 entry module to be embedded in wall (1 for blinds and the other for backup)</i>
	<i>Energy management: electrical domestic appliances (2 controlled sockets) ¹</i>
	<i>Ethernet and broadband Internet sockets</i>
	<i>TV via cable, satellite, ADSL or IPTV sockets</i>
	<i>Bus Cable</i>
<i>Living room (li)</i>	
	<i>Motor for blinds</i>
	<i>Wall mounted multifunctional switch near the door (controlling automated blinds and lights) / 4 entry module to be embedded in wall (2 for blinds and two for backup)</i>
	<i>Remote control (control for blinds)</i>
	<i>Ethernet and broadband Internet sockets</i>
	<i>TV via cable, satellite, ADSL or IPTV sockets</i>
	<i>Bus Cable</i>
<i>Dining room (di)</i>	
	<i>Movement detector near the door facing the window</i>
	<i>Motor for blinds</i>
	<i>Wall mounted multifunctional switch near the door (controlling automated blinds and lights) / 2 entry module to be embedded in wall (1 for blinds and the other for backup)</i>
	<i>Remote control (control for blinds)</i>
	<i>Ethernet and broadband Internet sockets</i>
	<i>TV via cable, satellite, ADSL or IPTV sockets</i>

Home office (ho)	Bus Cable
Laundry (la)	Motor for blinds
	Wall mounted multifunctional switch near the door (controlling automated blinds and lights) / 2 entry module to be embedded in wall (1 for blind and the other for backup)
	Remote control (control for blinds)
	Ethernet and broadband Internet sockets
	TV via cable, satellite, ADSL or IPTV sockets
	Bus Cable
Private bathroom (ba.p1)	Gas detector
	Water detector
	Motor for blinds
	Wall mounted multifunctional switch near the door (controlling automated blinds and lights) / 2 entry module to be embedded in wall (1 for blinds and the other for backup)
	Remote control (control for blinds)
	Energy management: electrical domestic appliances (2 controlled sockets) ¹
	Ethernet and broadband Internet sockets
	Bus Cable
Private bathroom (ba.p2)	Water detector
	Movement detector near the door facing the window
	Motor for blinds
	Wall mounted multifunctional switch near the door (controlling automated blinds and lights) / 2 entry module to be embedded in wall (1 for blinds and the other for backup)
	Remote control (control of blinds)
	Bus Cable
Guest bathroom (ba.g)	Water detector
	Wall mounted multifunctional switch near the door (lights)
	Bus Cable
Hall (hl)	Water detector
	Movement detector near the door facing the window
	Motor for blinds
	Wall mounted multifunctional switch near the door (controlling automated blinds and lights) / 2 entry module to be embedded in wall (1 for blinds and the other for backup)
	Remote control (control for blinds)
	Bus Cable
Hall (hl)	Smoke detector
	Movement detector facing the entrance to the dwelling
	Entry phone
	Bus Cable
	Ethernet and broadband Internet sockets
	Wall mounted multifunction switch (lights)
	Touch panel (control of all the system)
	Alarm
	Electrically operated valve to switch off water, gas and electricity
	Cupboard for domotics with:
	Power module for the entire system
	Exit modules for the 12 blinds
	Exit modules for the controlled sockets for the domestic appliances
	Modem

<i>Media coupler (allows transmission of RF product messages)</i>	
<i>Corridors (co.p1)</i>	
	<i>Bus Cable</i>
	<i>Ethernet and broadband Internet sockets</i>
	<i>Wall mounted multifunction switch (lights)</i>
<i>Corridors (co.p2)</i>	
	<i>Bus Cable</i>
	<i>Ethernet and broadband Internet sockets</i>
	<i>Wall mounted multifunction switch (lights)</i>
<i>Corridors (co1)</i>	
	<i>Movement detector facing the entrance to the dwelling</i>
	<i>Bus Cable</i>
	<i>Ethernet and broadband Internet sockets</i>
	<i>Wall mounted multifunction switch (lights)</i>
<i>Corridors (co2)</i>	
	<i>Bus Cable</i>
	<i>Ethernet and broadband Internet sockets</i>
	<i>Wall mounted multifunction switch (lights)</i>

Table 19 – Description of the ICAT elements

¹ Electrical domestic appliances that can be programmed to remain ON without using energy can be remotely controlled by cutting or activating power to the socket to which they are connected. Alternatively, they may use a pre-programmed start function or be activated remotely.

Floor plan



Justified graph

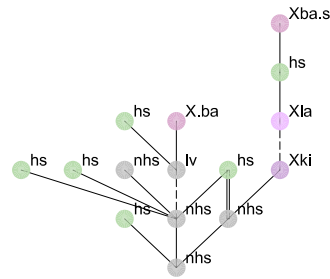

Graph with a tree configuration with 1 ring
 Graph with 6 levels of depth
 15 spaces/nodes
 15 arcs/connections

Convex map

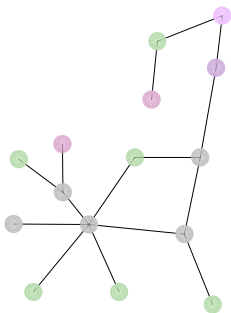

Distributness

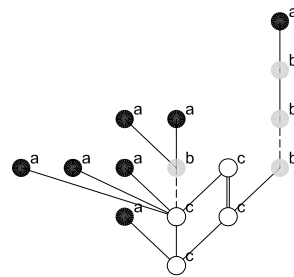

- Habitable spaces (hs)
- Non-habitable spaces (nhs)
- Existing kitchen (Xki)
- Existing bathrooms (Xba)
- Existing laundry (Xla)
- a _ terminal spaces
- b _ reached by two arcs
- c _ reached by two or more arcs and connected in a ring

Controle

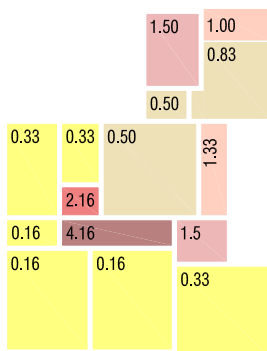

Entire dwelling
 Mean: 1,00

Contiguity

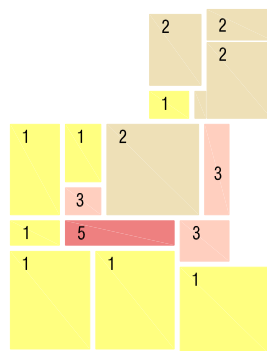

Depth

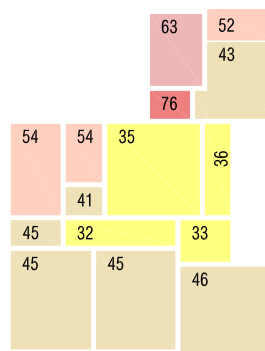

Entire dwelling
 Mean: 46,66

Integration

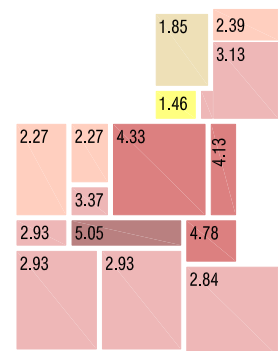

Entire dwelling
 Mean: 3,11

Adjacency (arcs)
 merged — door (single) == door (double) - - - passage ~ window

Higher Lower 1 2 3 4 5 10

derivation: functional transformation

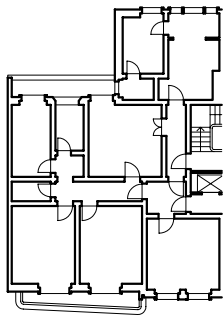

floor plan

spatial void

graphs

weights

labels

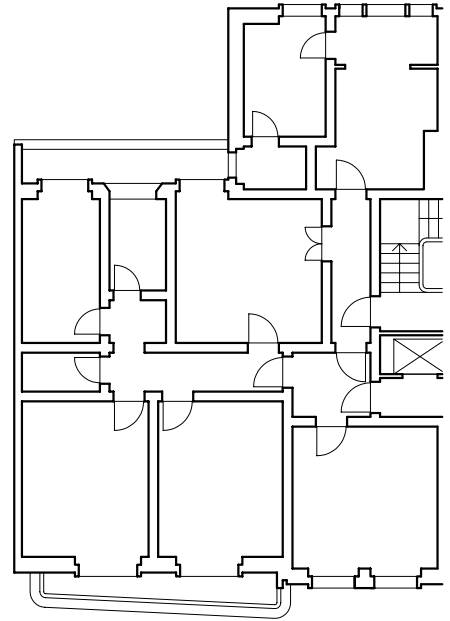

Overlapped representation on the dwelling

derivation: functional transformation

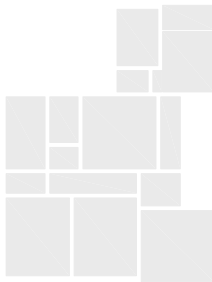
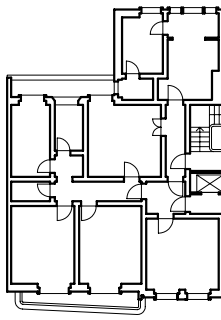

floor plan

spatial void

graphs

weights

labels

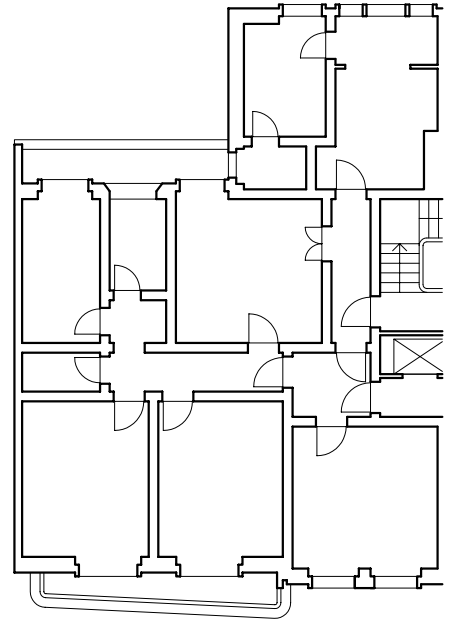

Overlapped representation on the dwelling

#1

Rules -1.1

Creation of a compound representation

Note: spatial voids will not be represented overlapped with the top representation because it would become graphically too confuse

derivation: functional transformation

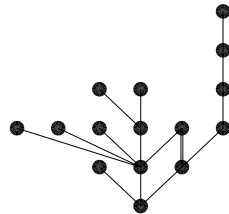
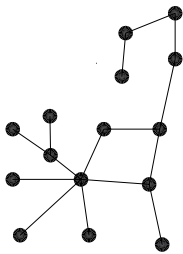
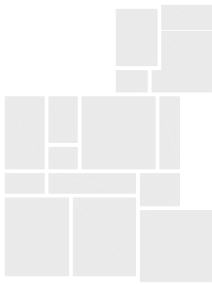
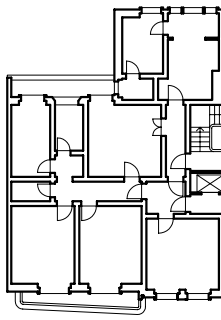

floor plan

spatial void

graphs

weights

labels

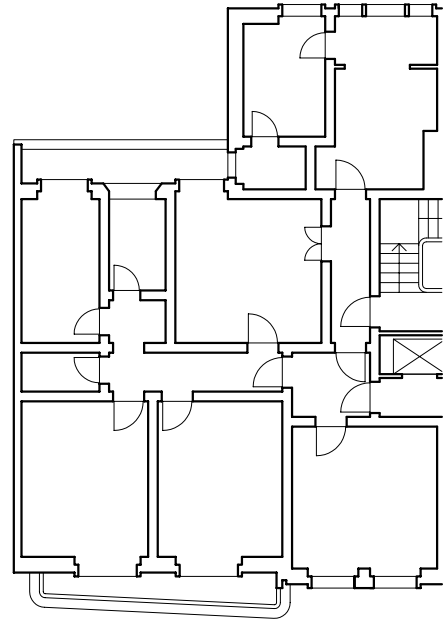

Overlapped representation on the dwelling

#2

Rules -1.2

Creation of a compound representation

Note: graphs (nodes and links) will not be represented overlapped with the top representation because it would become graphically too confuse

derivation: functional transformation

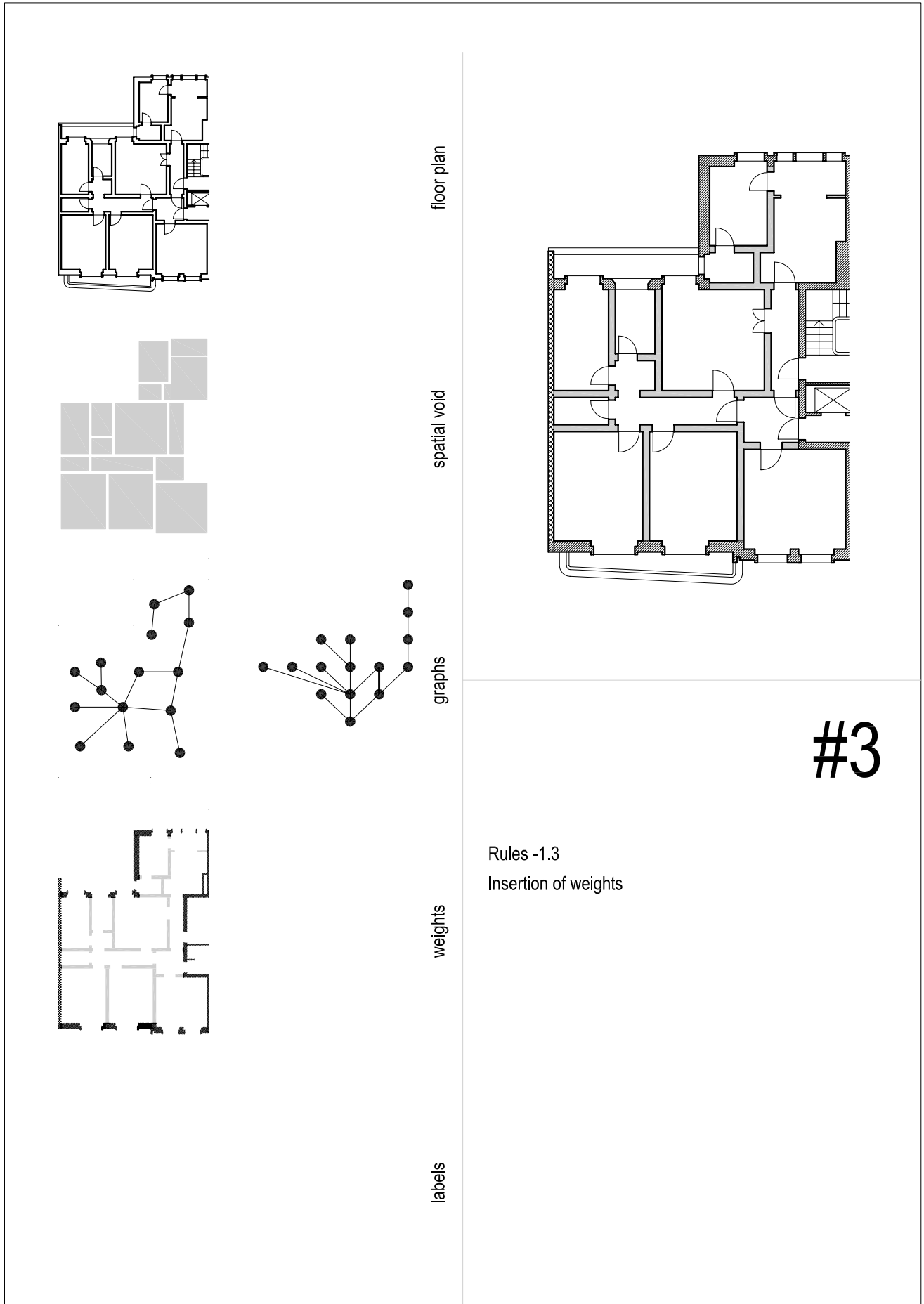

derivation: functional transformation

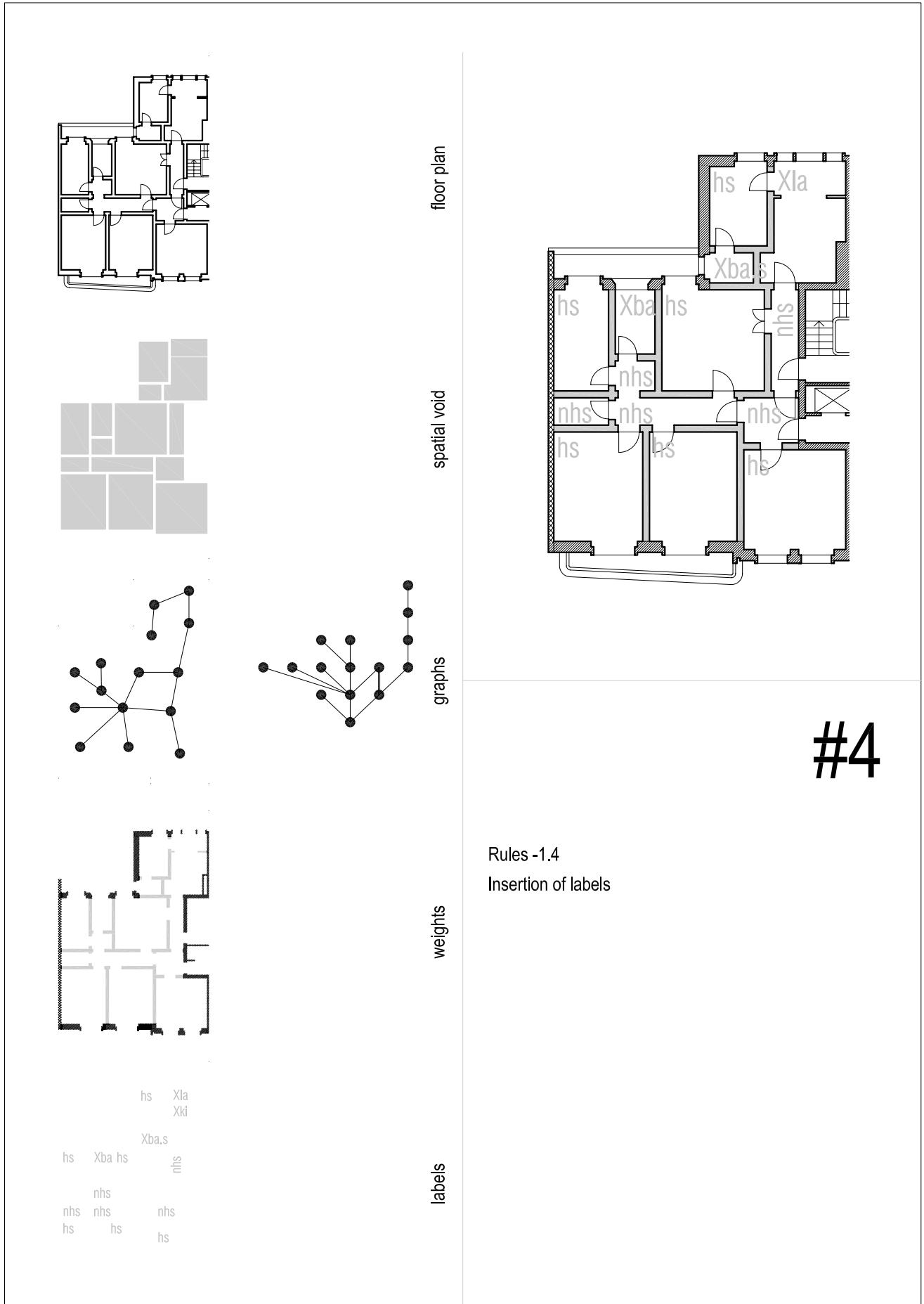

derivation: functional transformation

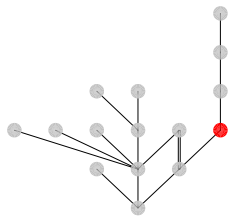
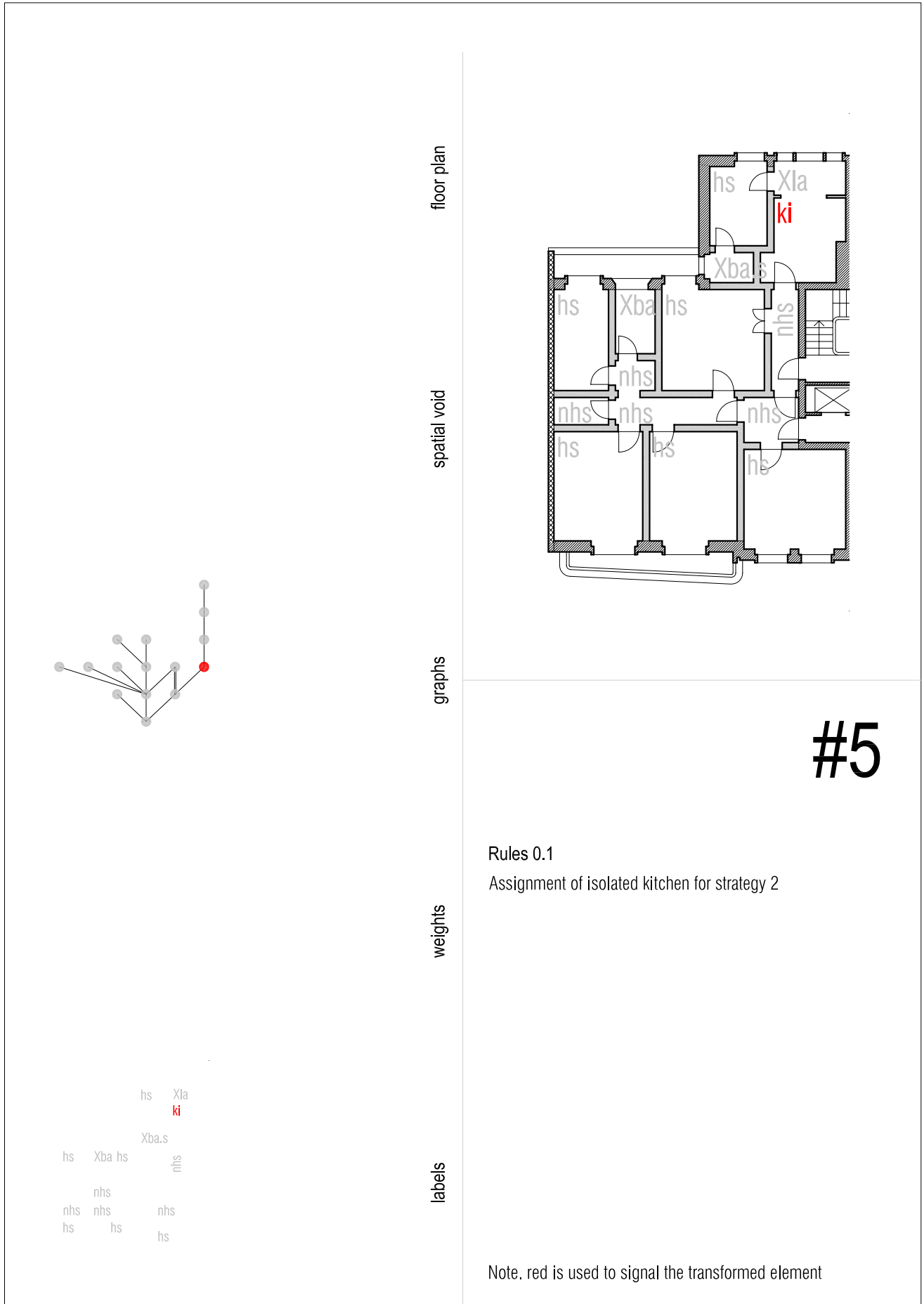

Note, red is used to signal the transformed element

derivation: functional transformation

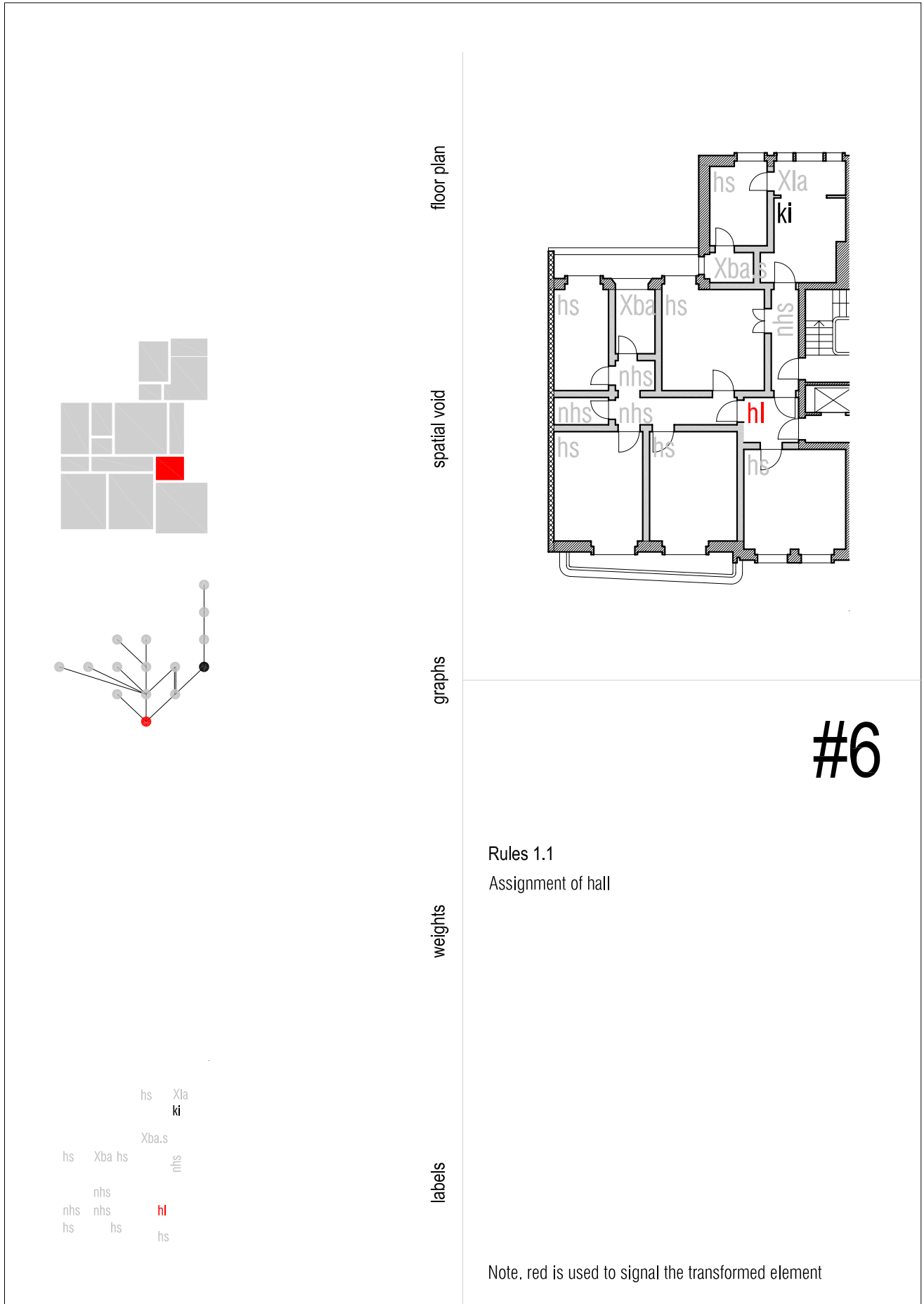

derivation: functional transformation

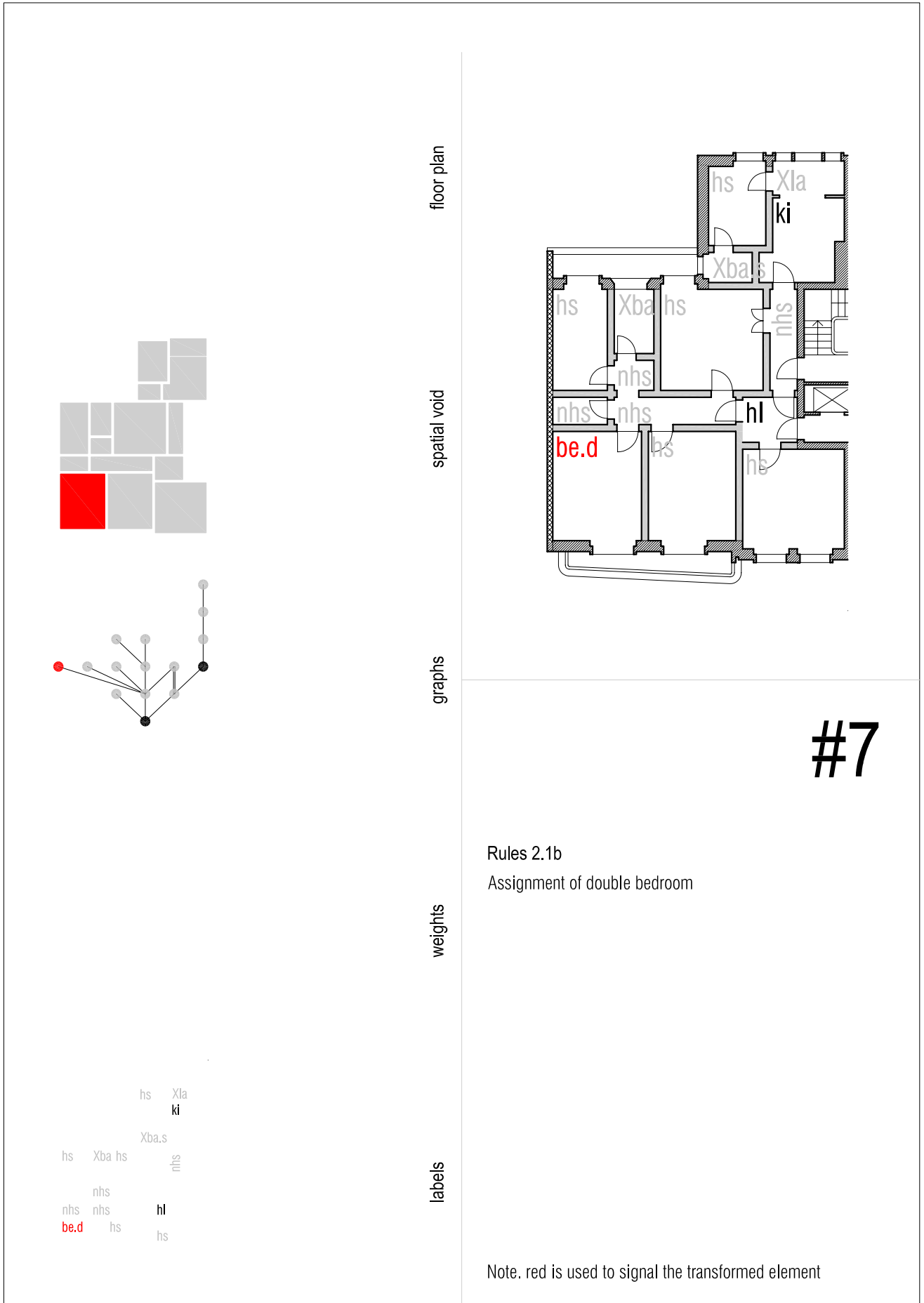

derivation: functional transformation

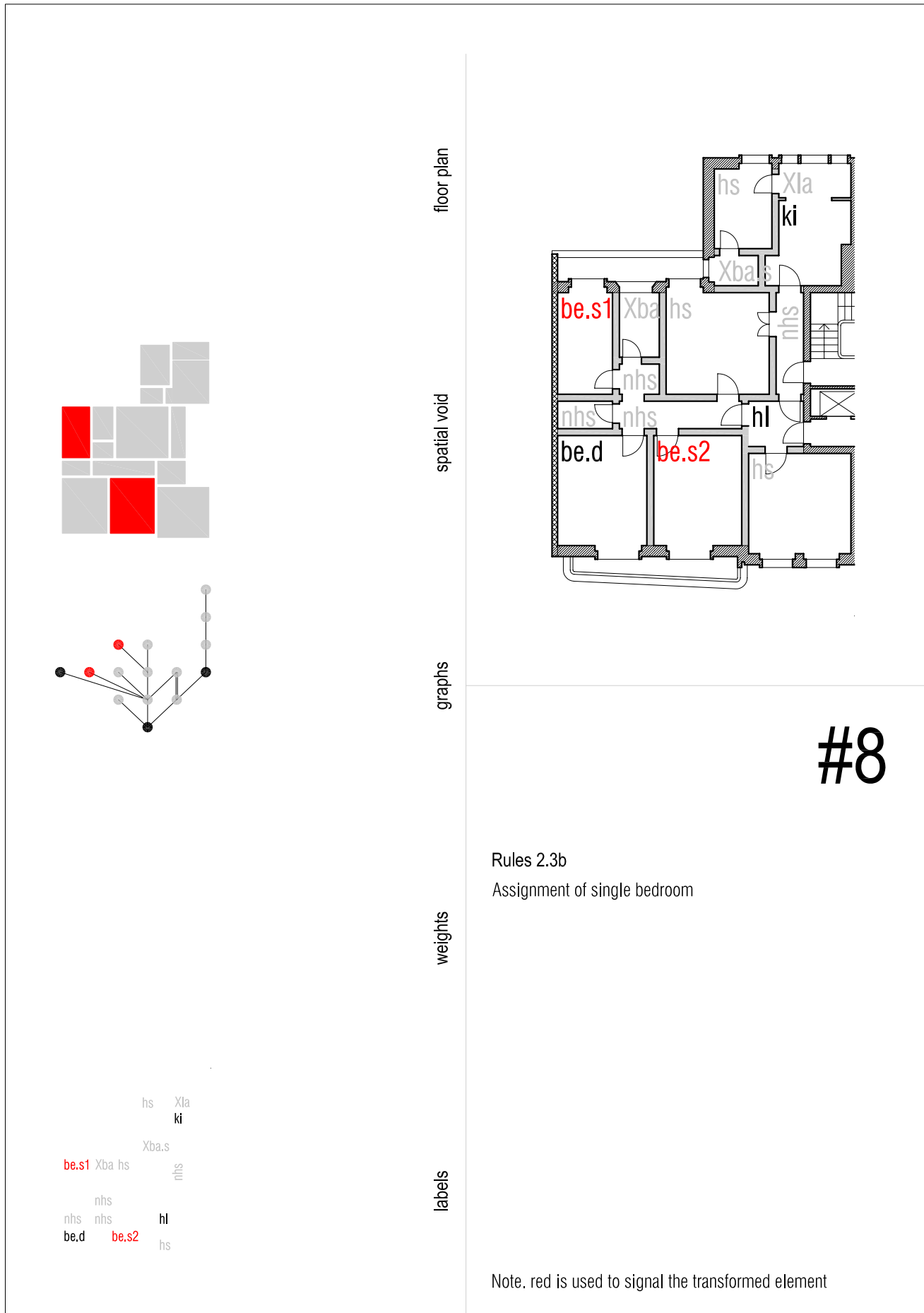

derivation: functional transformation

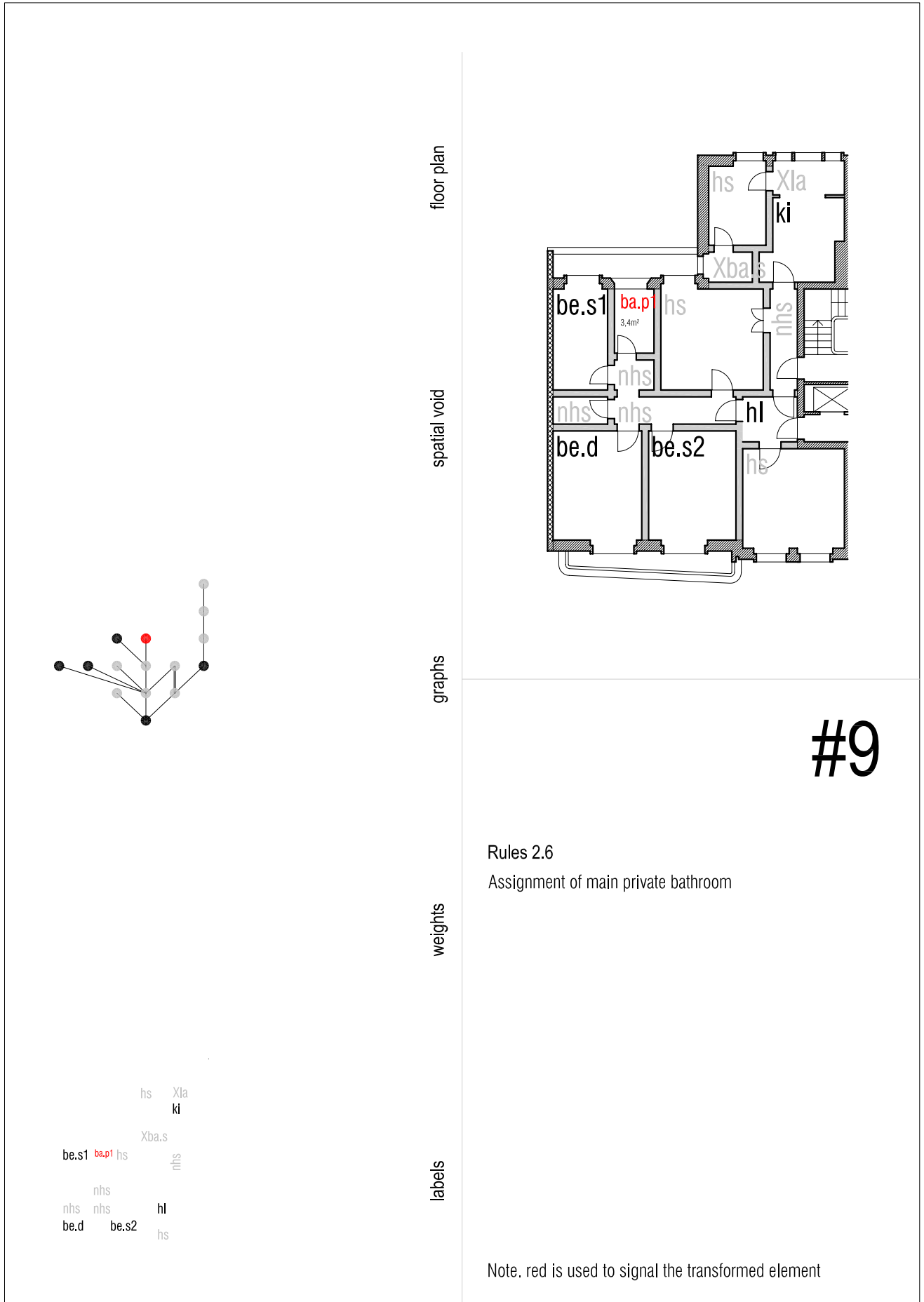

derivation: functional transformation

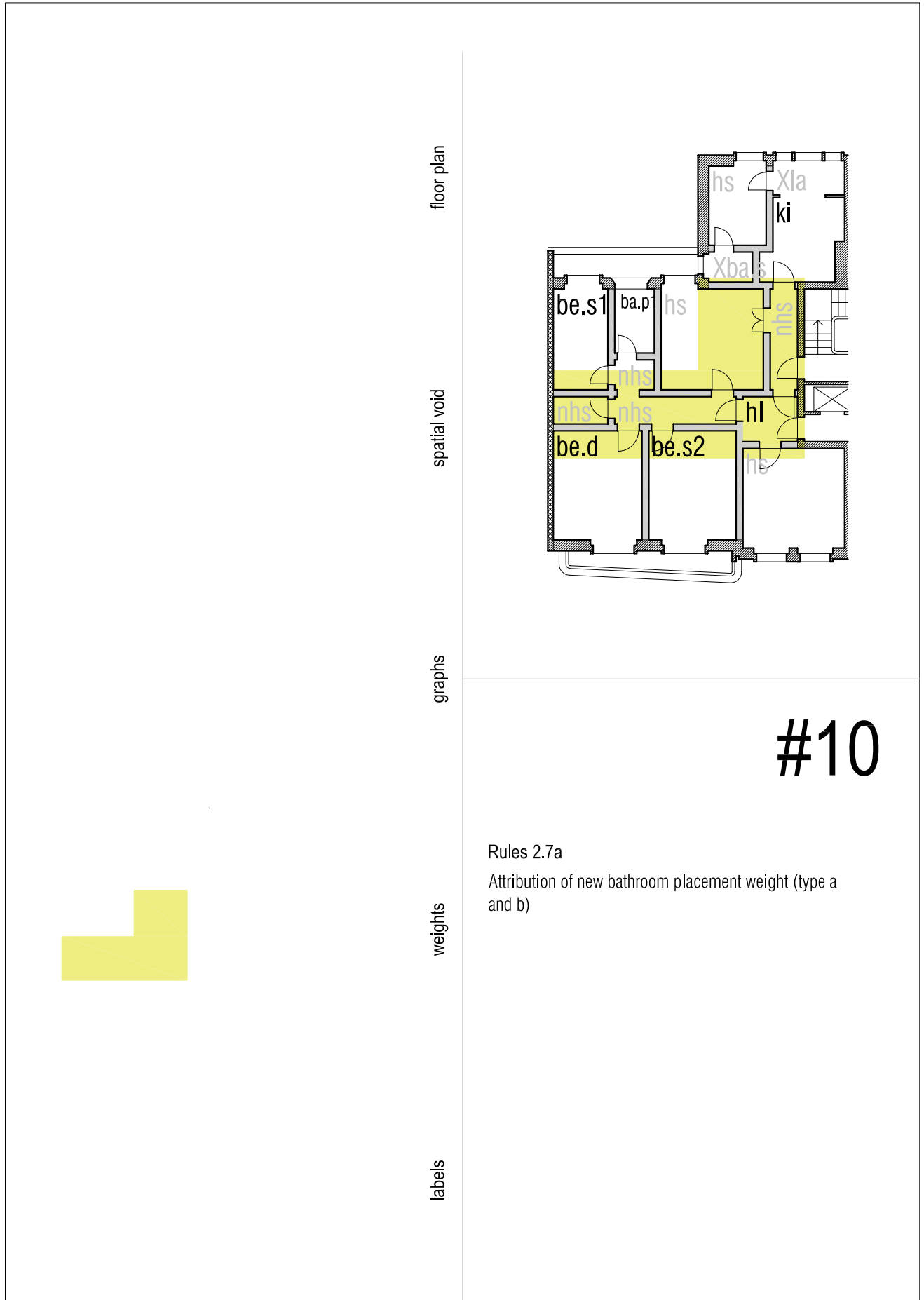

derivation: functional transformation

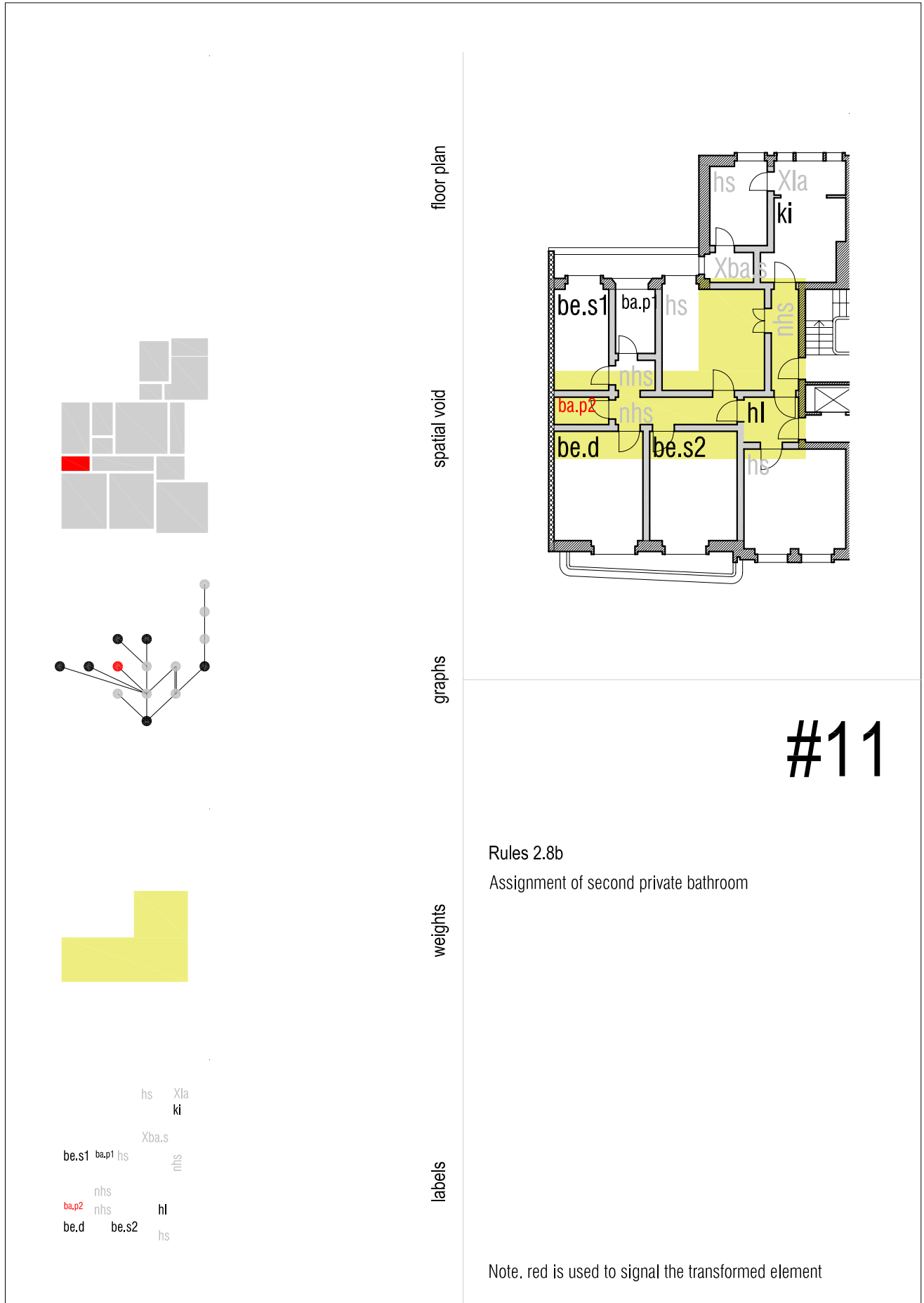

derivation: functional transformation

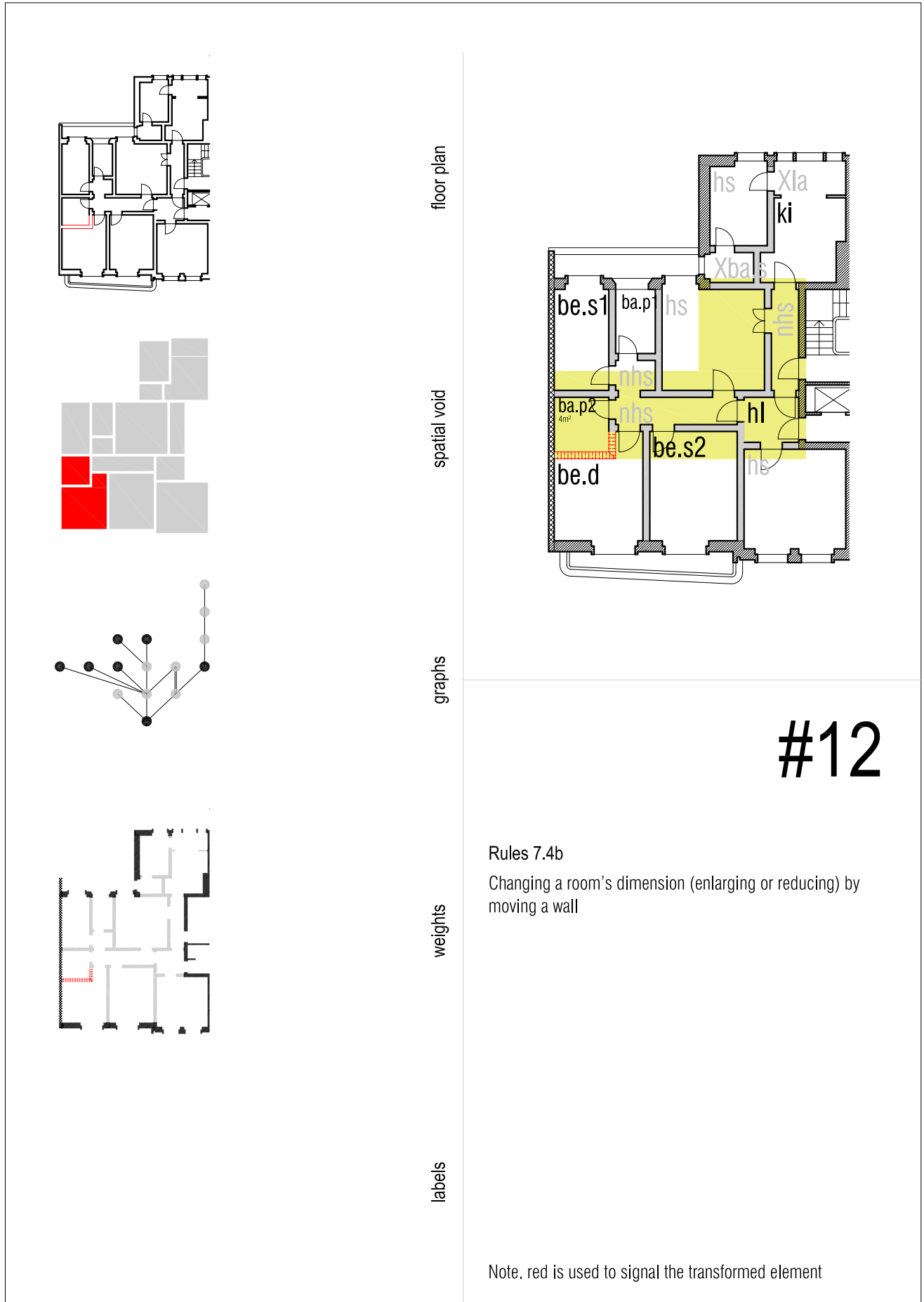

#12

Rules 7.4b

Changing a room's dimension (enlarging or reducing) by moving a wall

Note. red is used to signal the transformed element

derivation: functional transformation

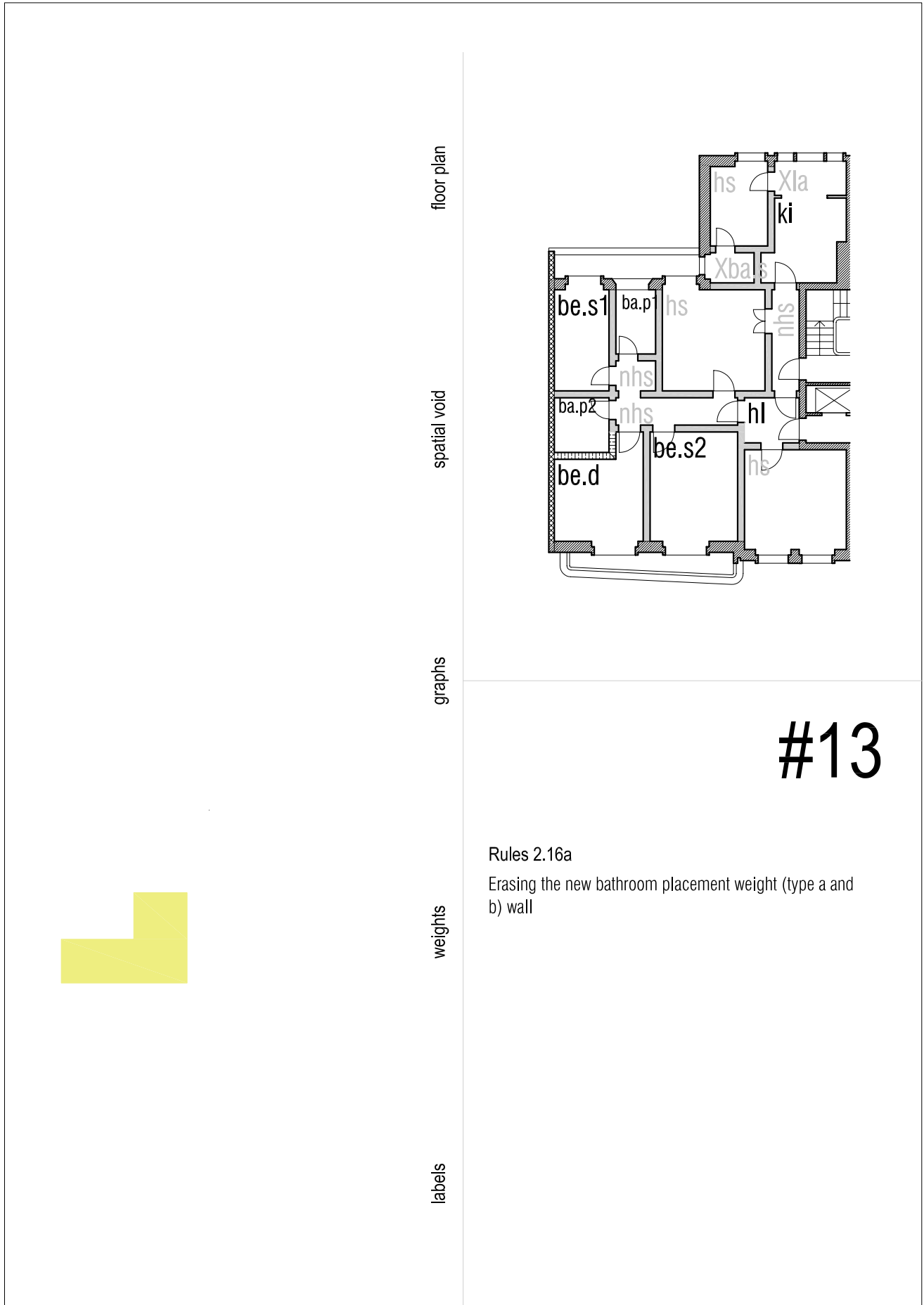

derivation: functional transformation

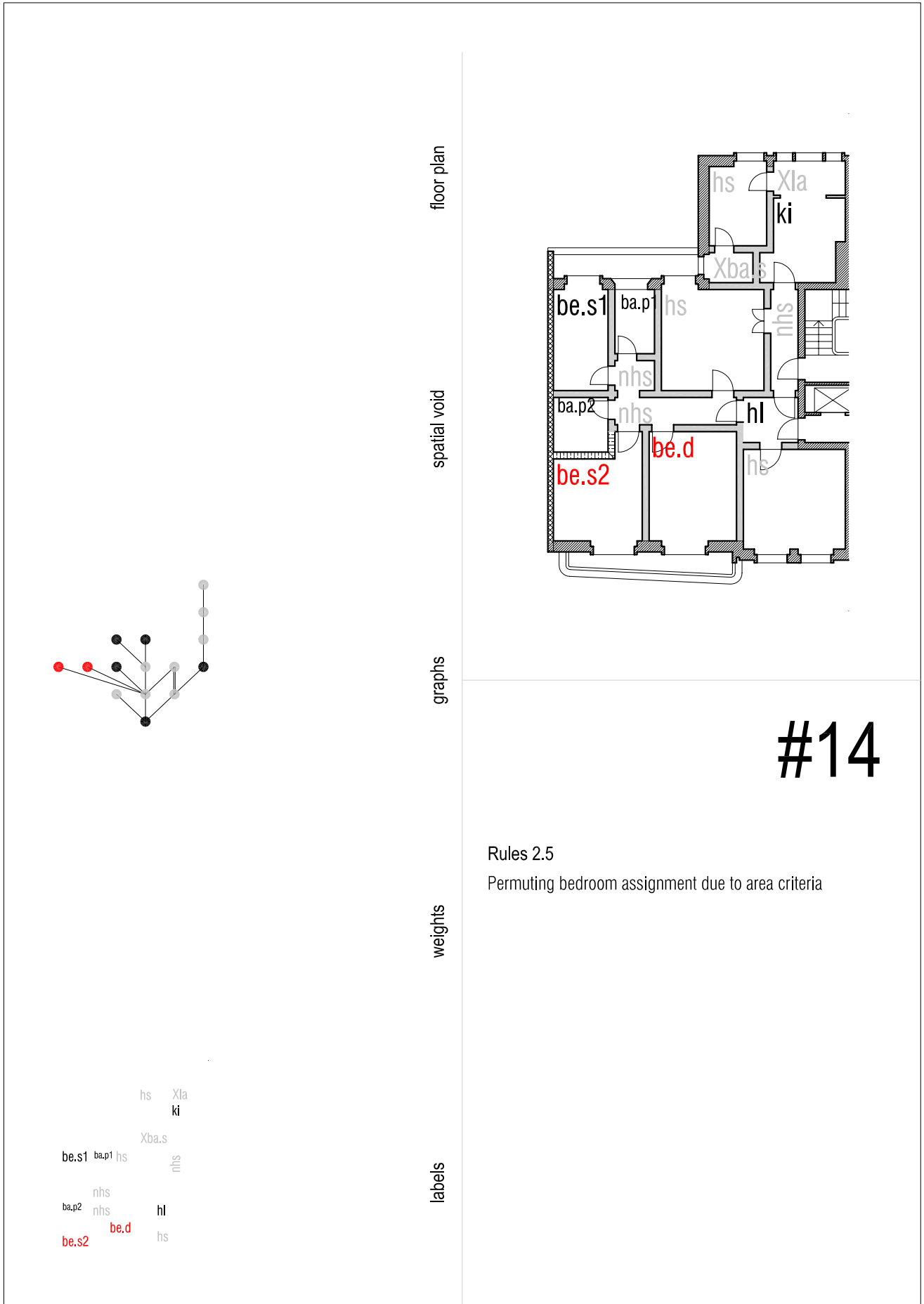

derivation: functional transformation

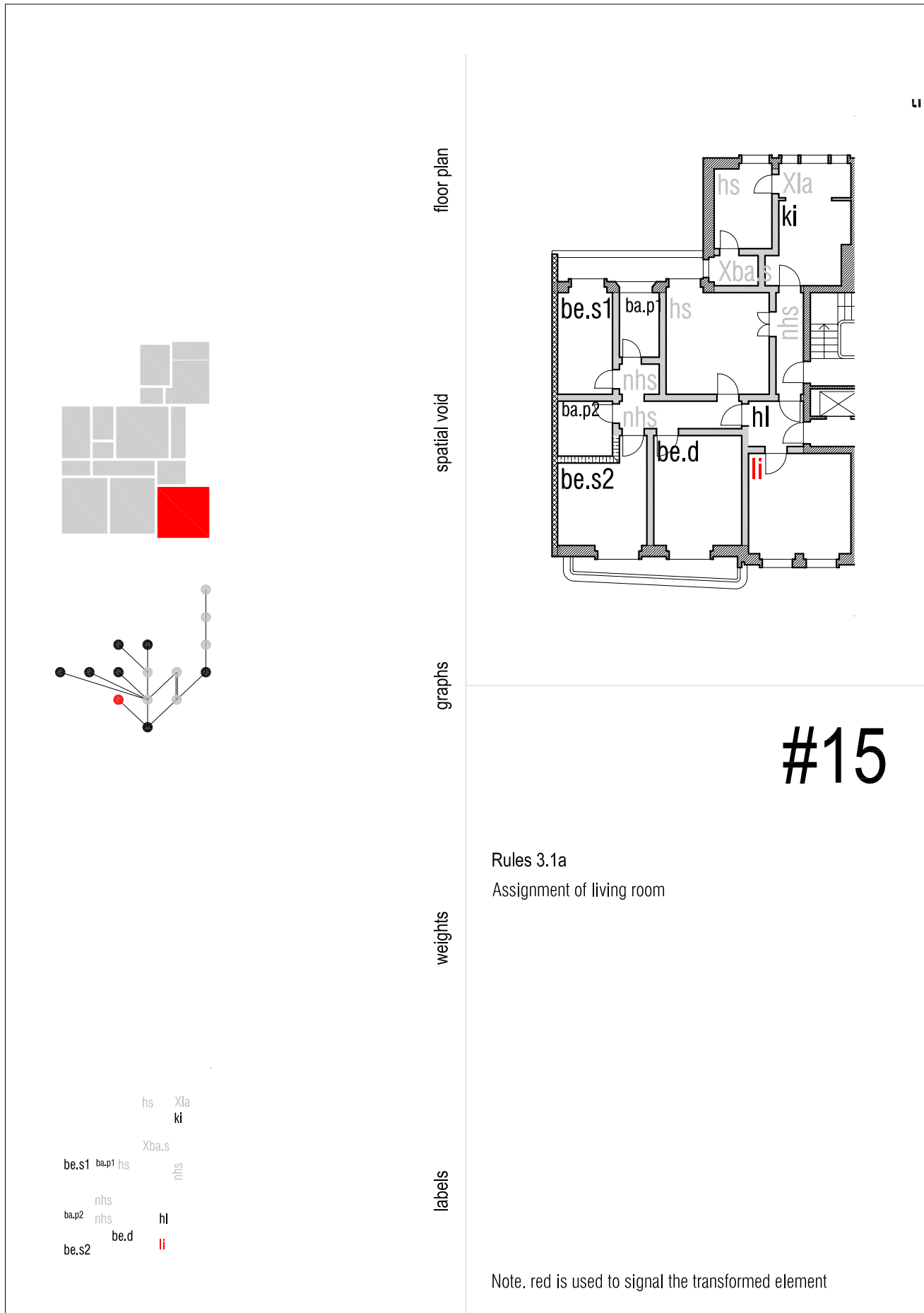

#15

Rules 3.1a
Assignment of living room

hs Xla
ki
Xba.s
be.s1 ba.p1 hs nhs
ba.p2 nhs hl
be.s2 be.d li

Note. red is used to signal the transformed element

derivation: functional transformation

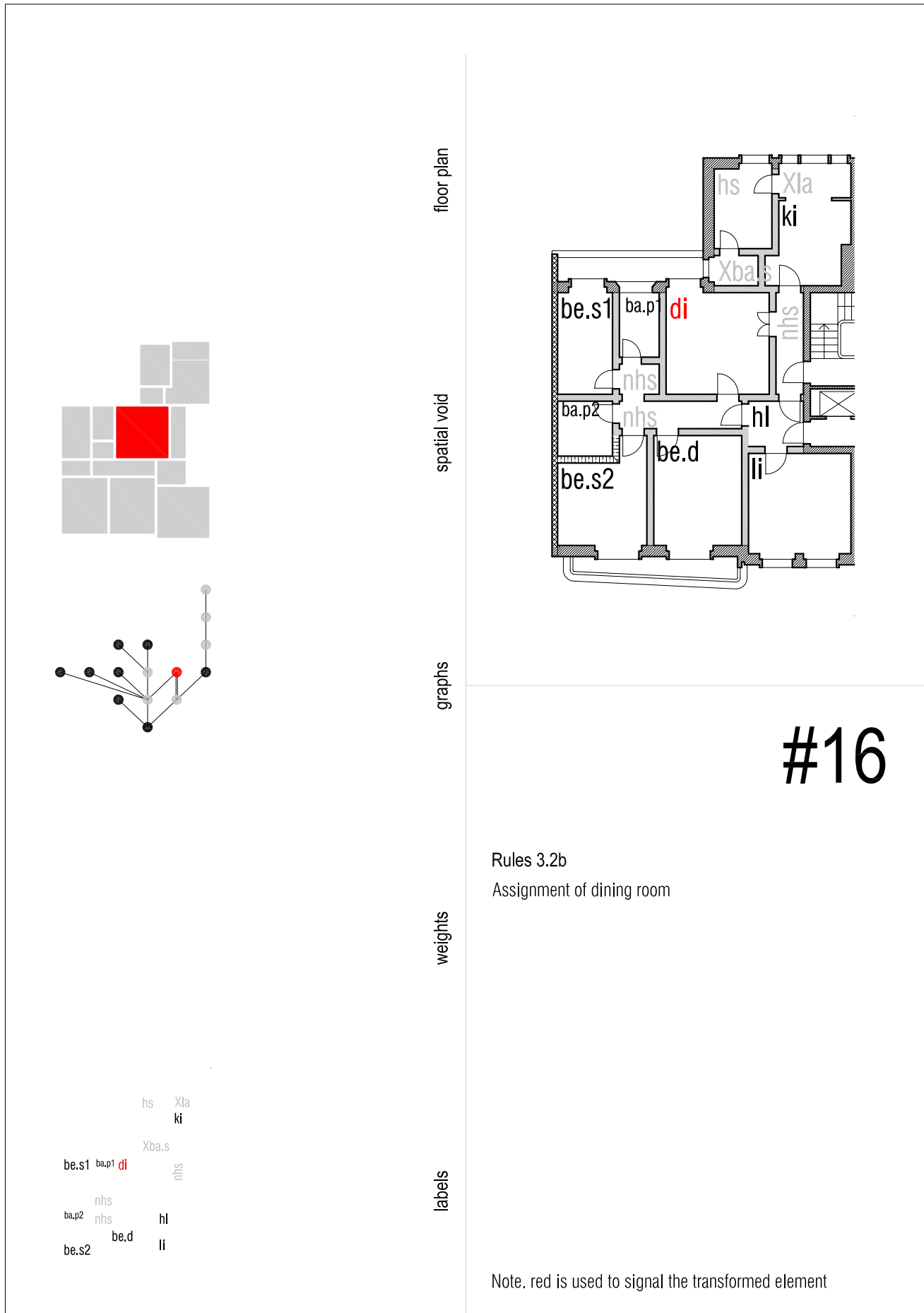

#16

Rules 3.2b
Assignment of dining room

Note. red is used to signal the transformed element

derivation: functional transformation

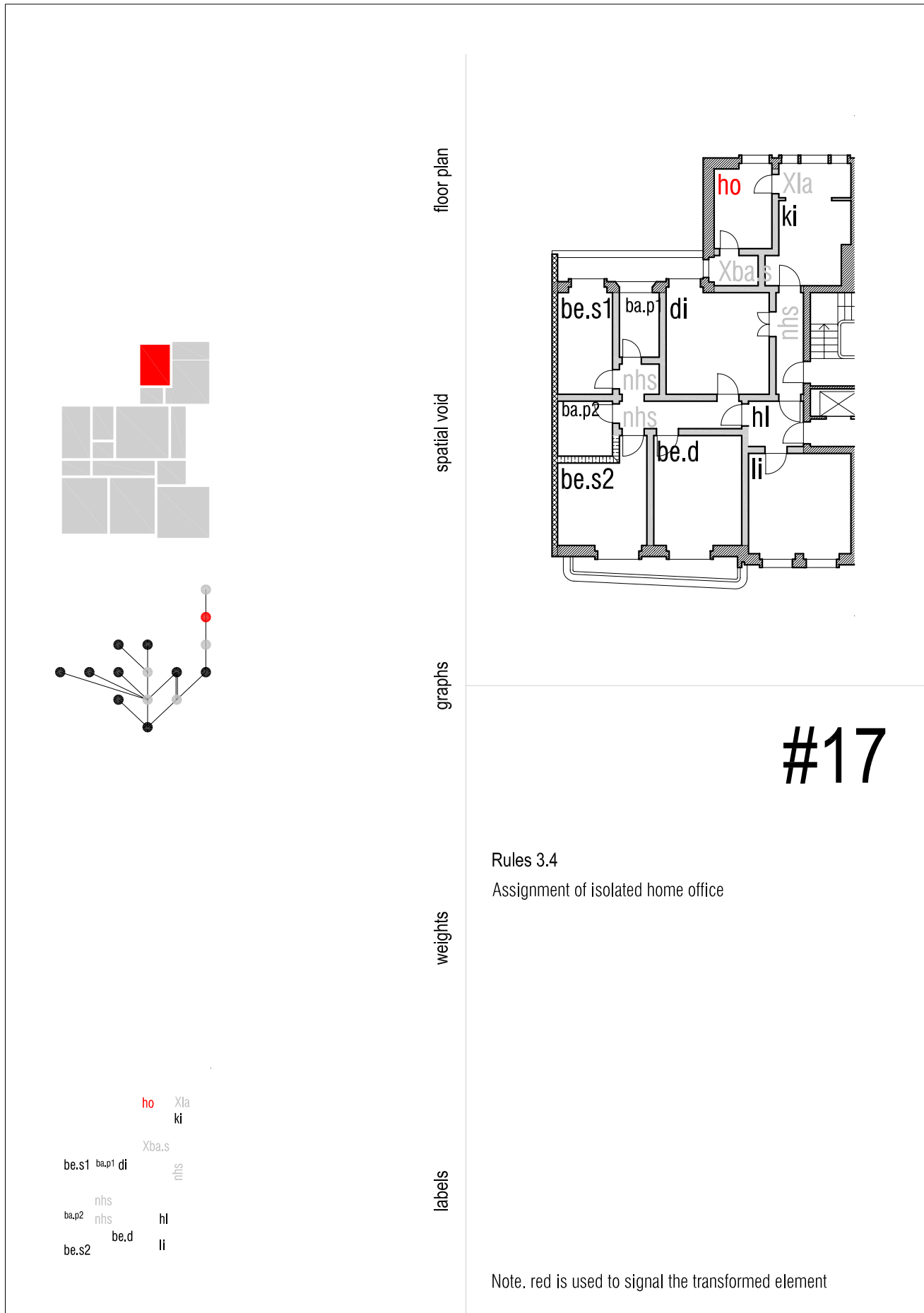

derivation: functional transformation

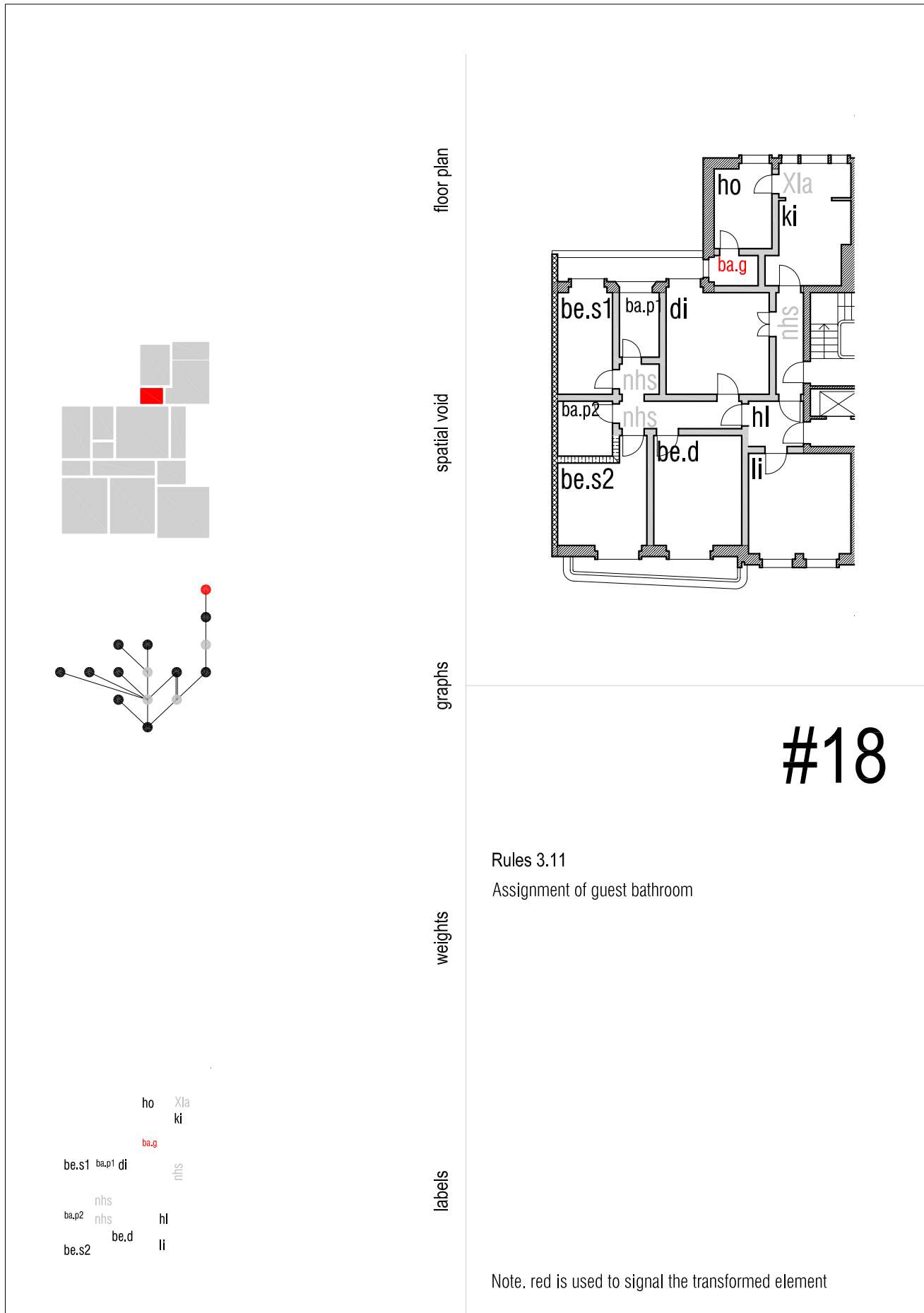

derivation: functional transformation

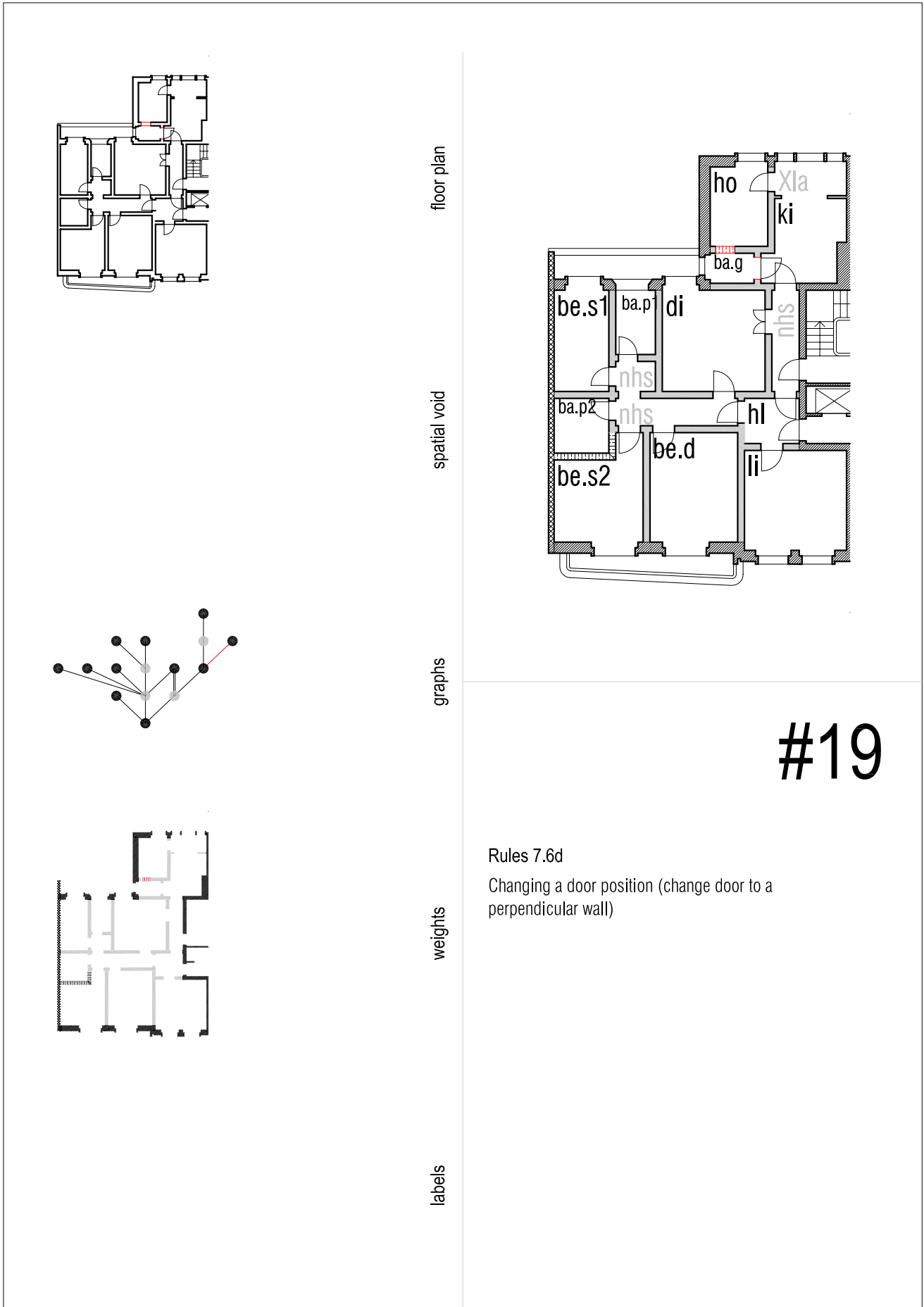

derivation: functional transformation

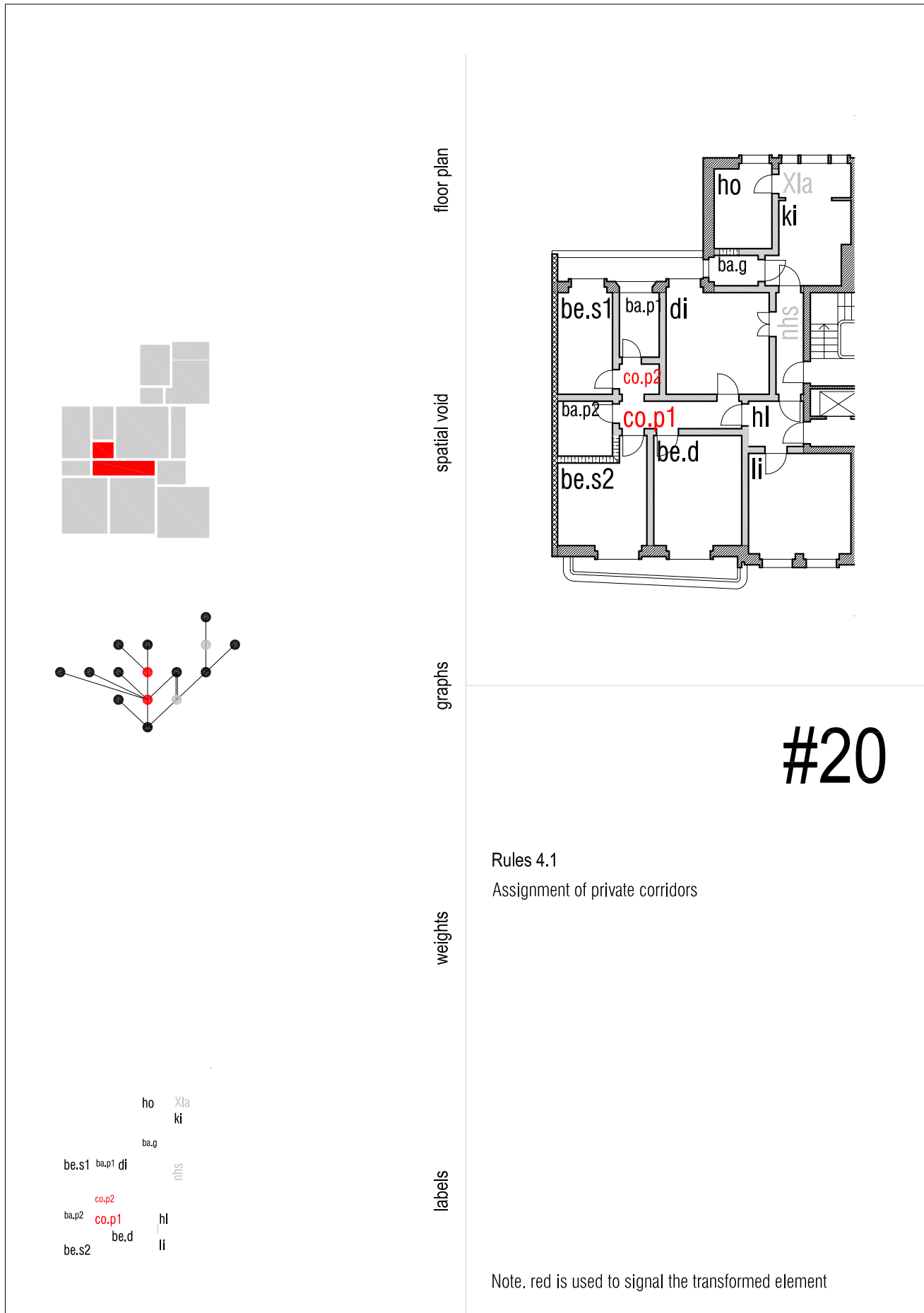

derivation: functional transformation

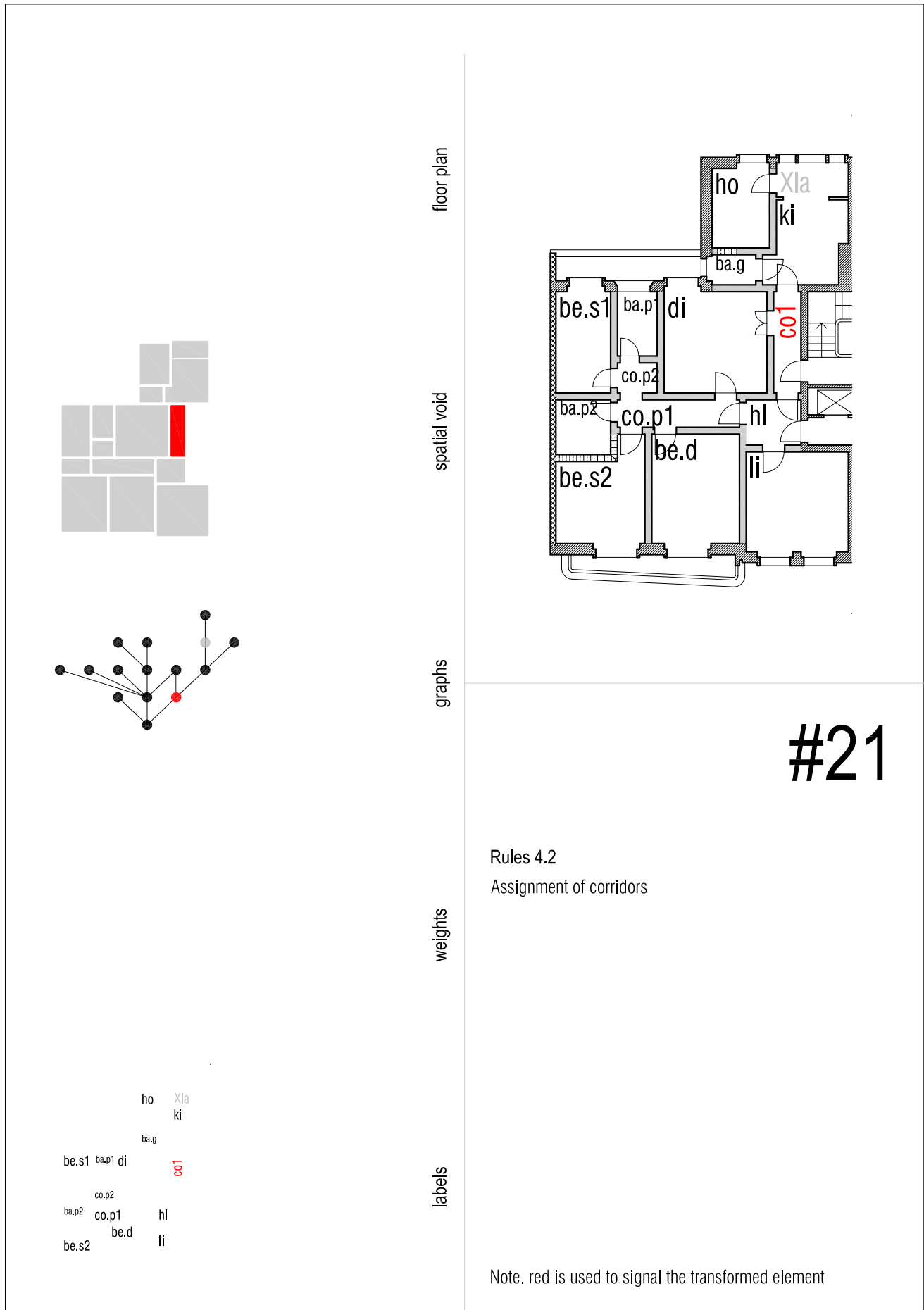

derivation: functional transformation

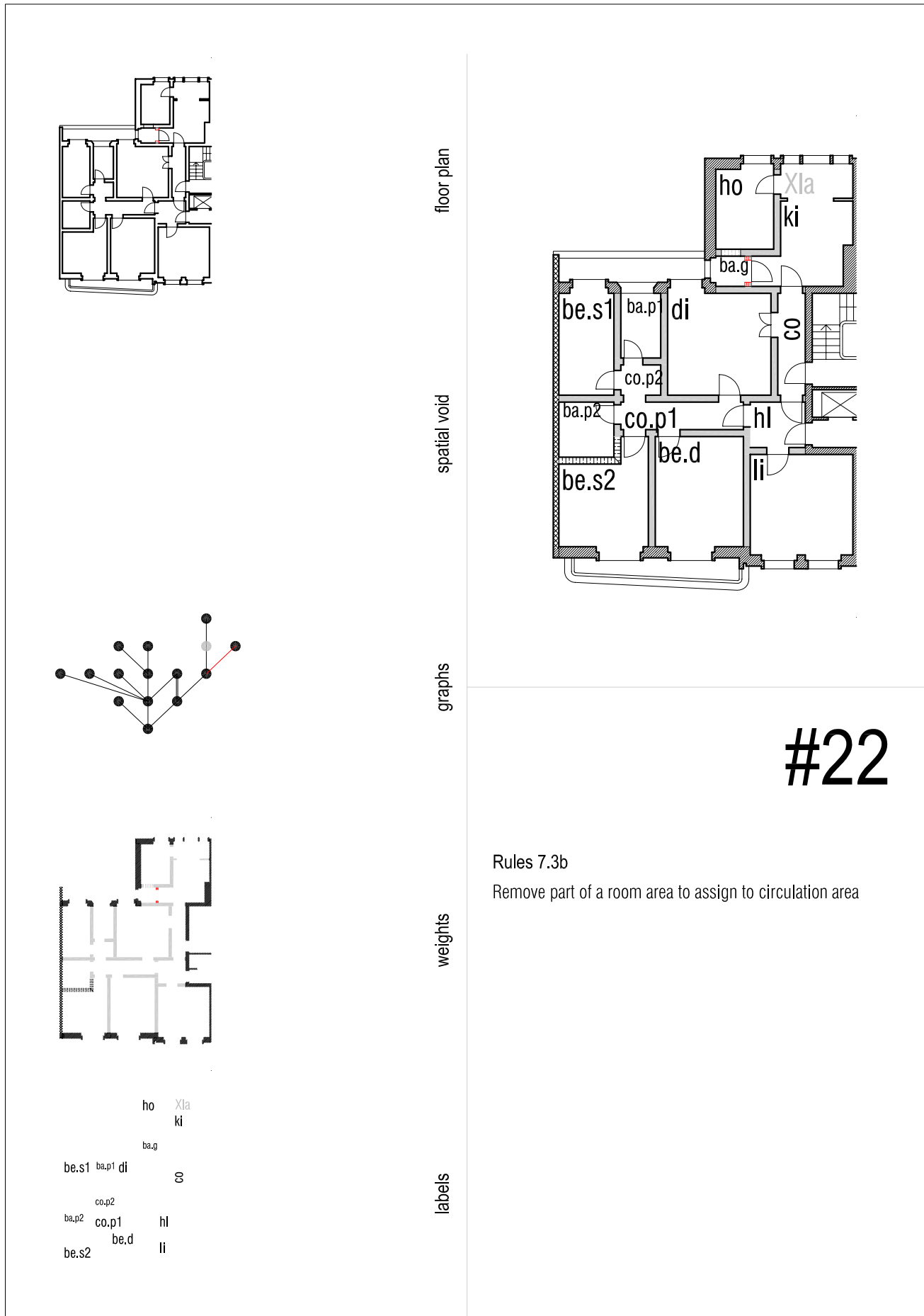

derivation: functional transformation

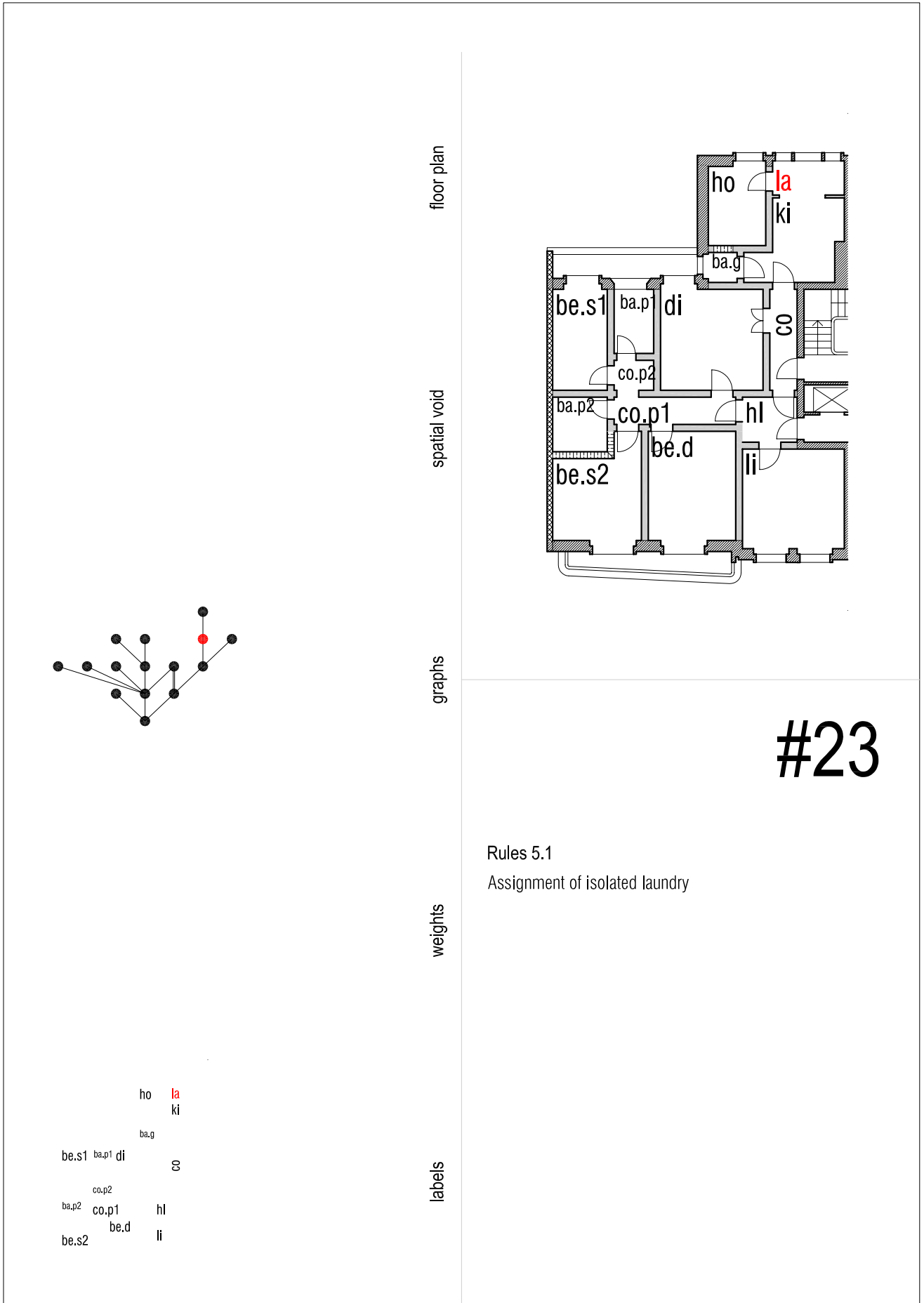

#23

Rules 5.1
Assignment of isolated laundry

ho la
 ki
 ba.g
be.s1 ba.p1 di ∅
 co.p2
ba.p2 co.p1 hl
 be.d li
be.s2

derivation: functional transformation

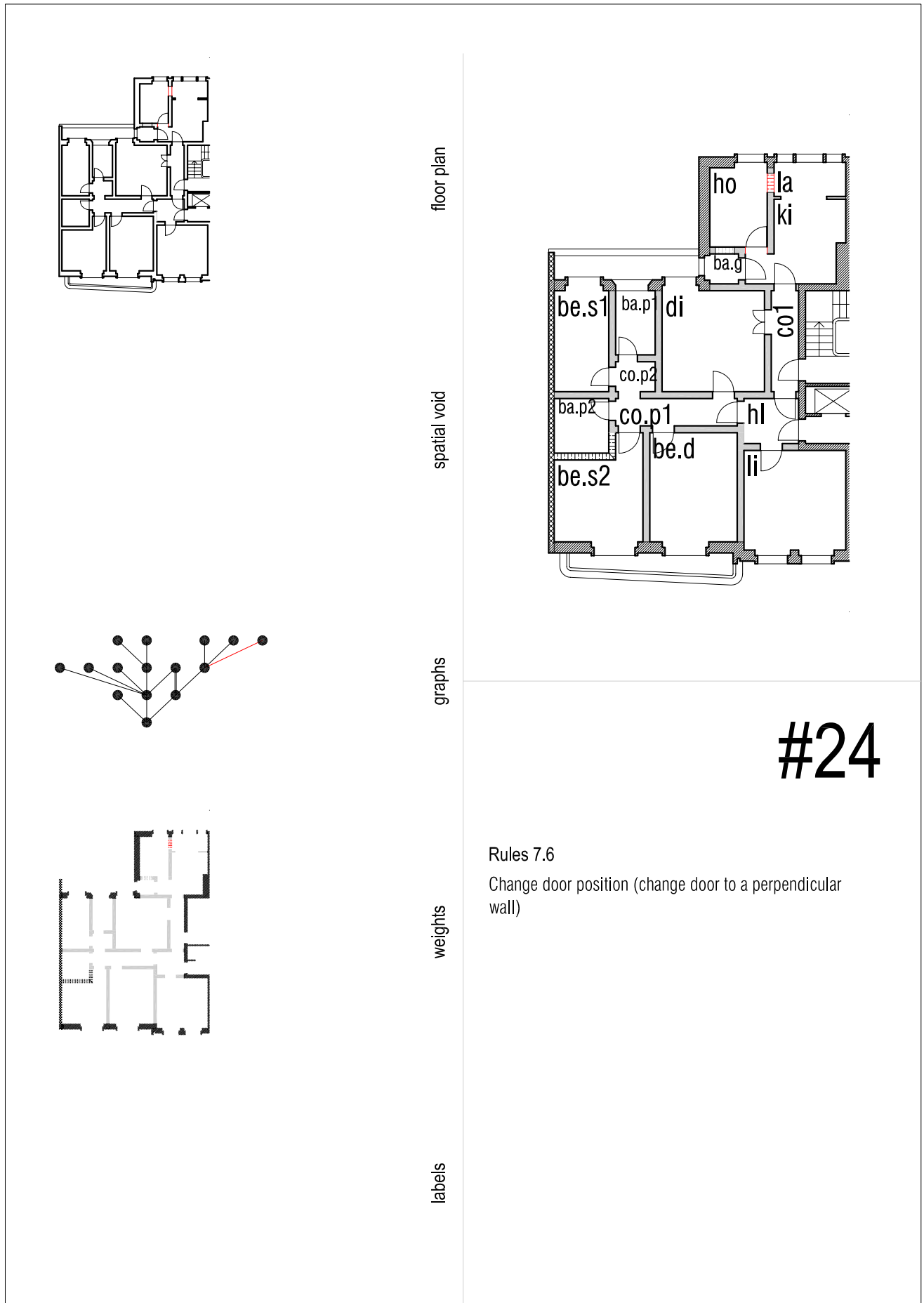

derivation: functional transformation

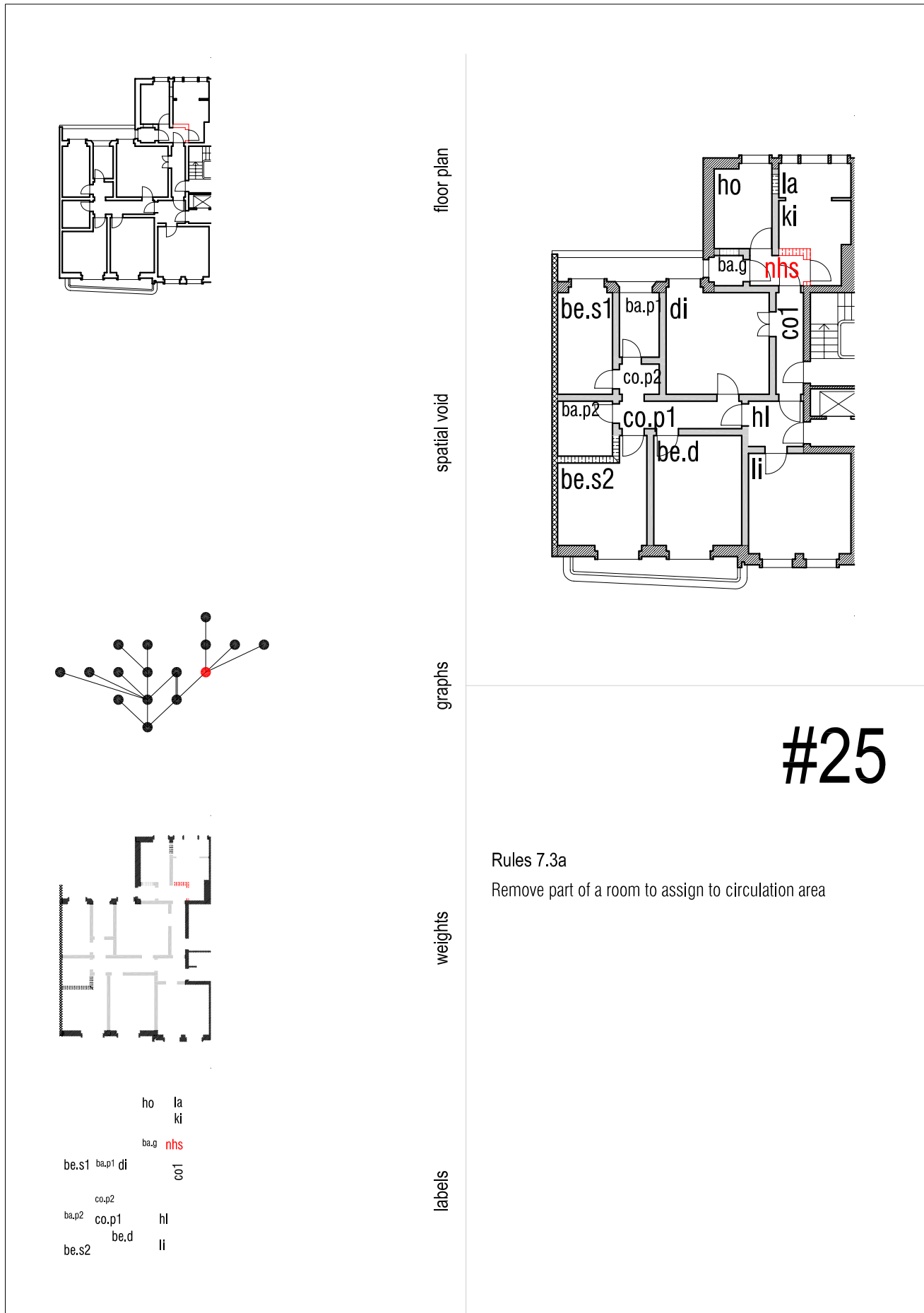

#25

Rules 7.3a
Remove part of a room to assign to circulation area

- ho la
- ki
- ba.g nhs
- be.s1 ba.p1 di
- co.p2
- ba.p2 co.p1 hl
- be.d li
- be.s2

derivation: functional transformation

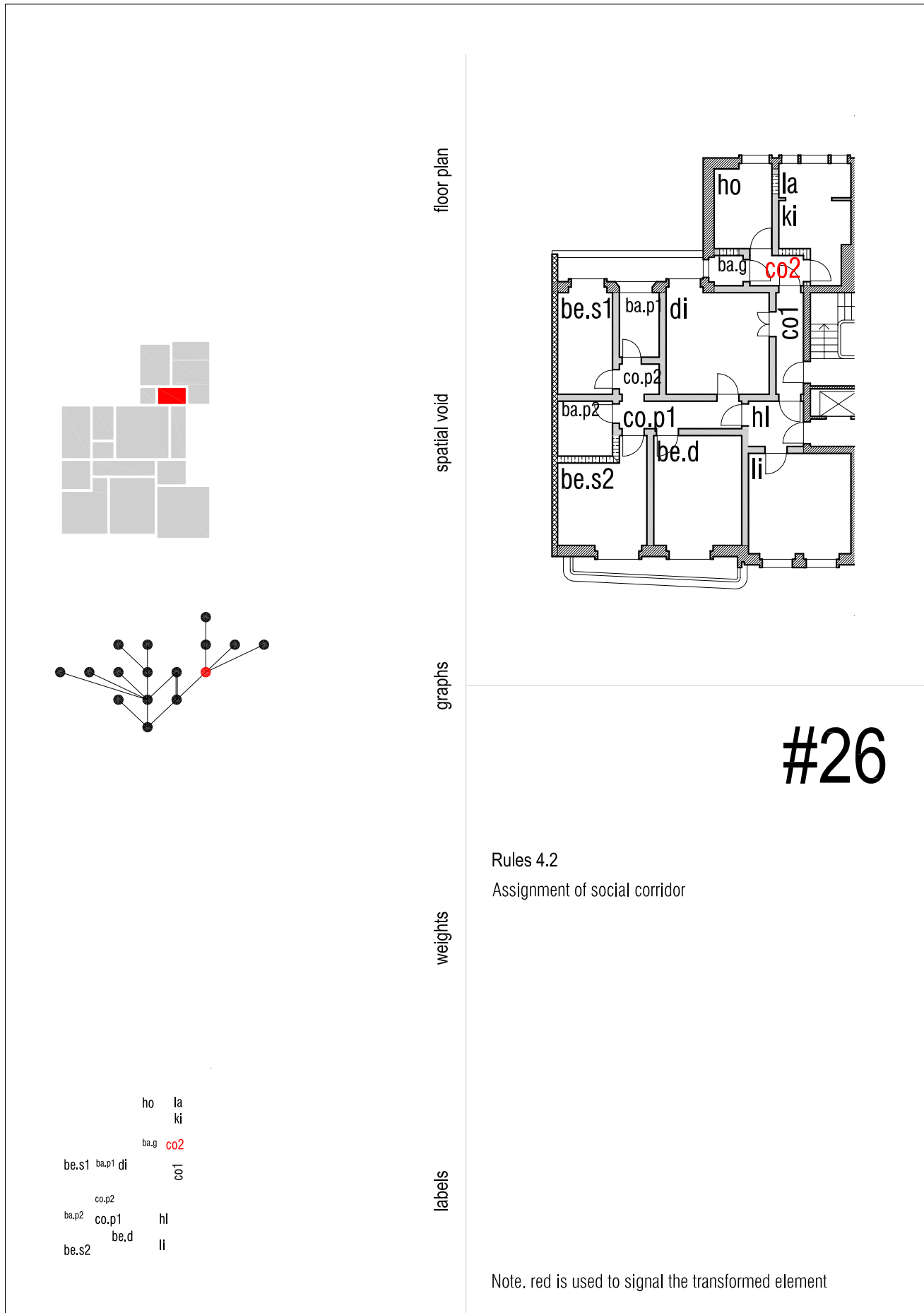

#26

Rules 4.2
Assignment of social corridor

Note. red is used to signal the transformed element

derivation: functional transformation

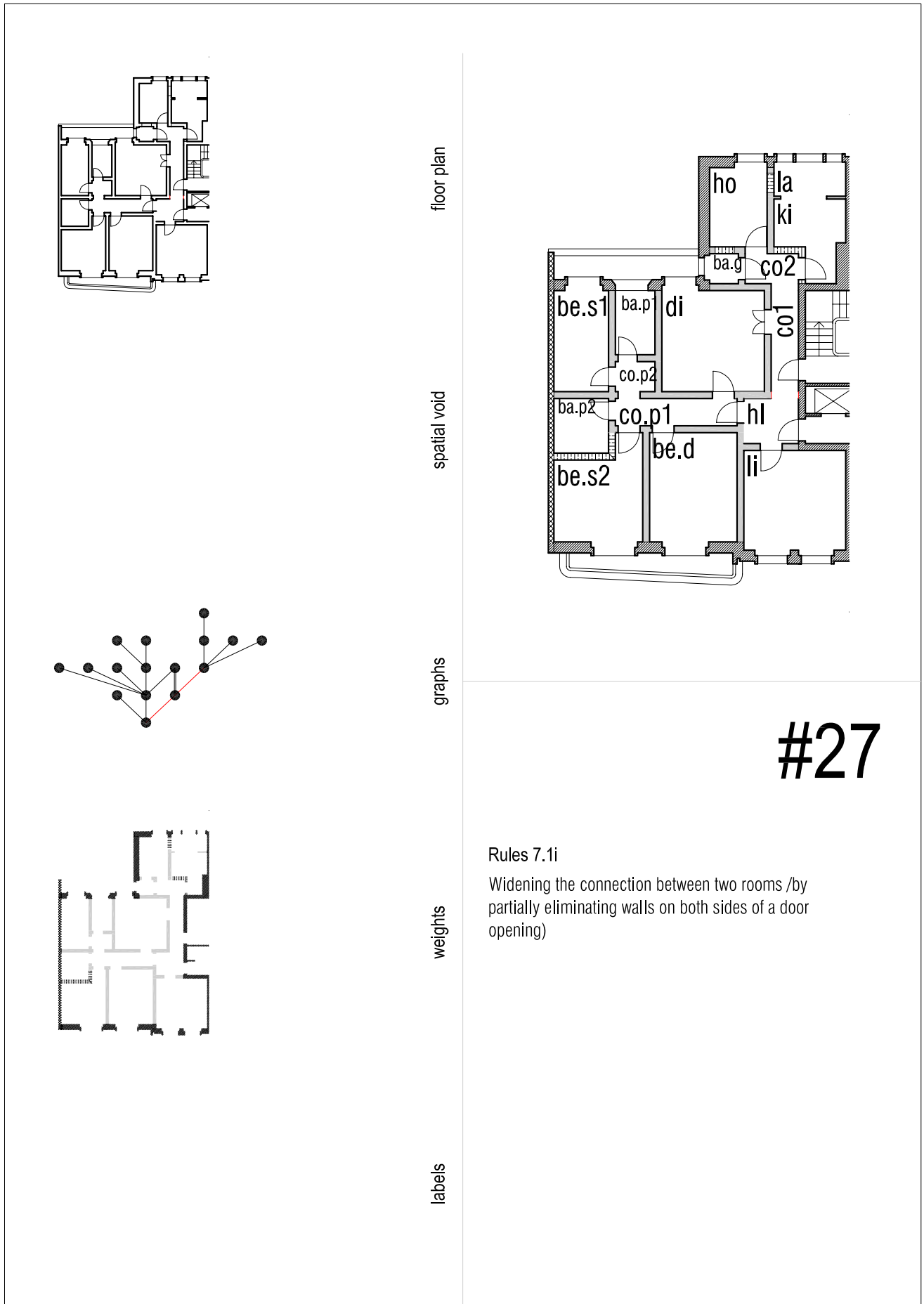

Floor plan

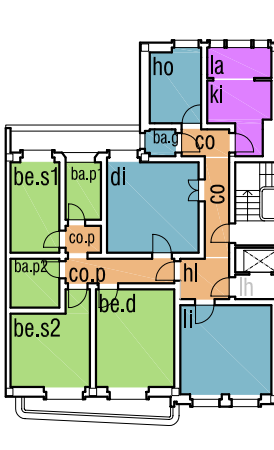

Justified graph

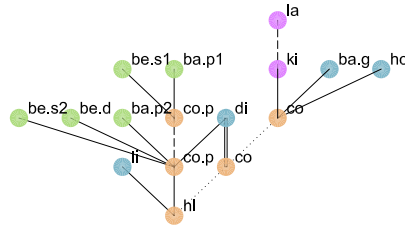

Graph with a tree configuration with 1 ring
 Graph with 5 levels of depth
 16 spaces/nodes
 16 arcs/connections

Convex map

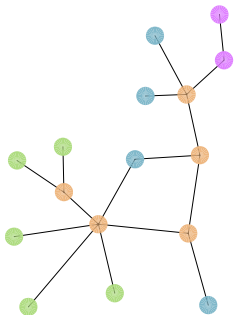

Distributness

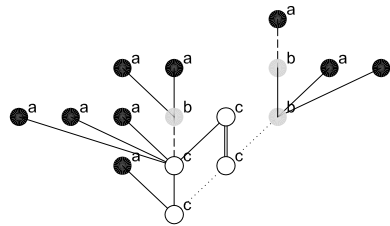

- Social area
- Private area
- Circulation area
- Service area
- a _ terminal spaces
- b _ reached by two arcs
- c _ reached by two or more arcs and connected in a ring

Controle

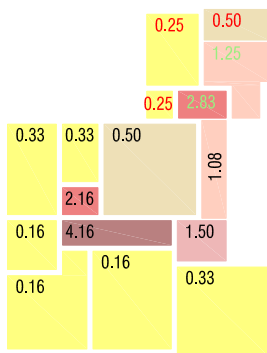

Entire dwelling
 Mean: 1,00

Contiguity

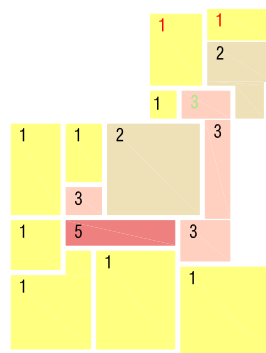

Depth

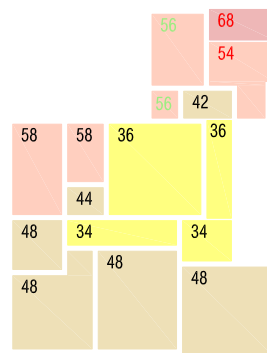

Entire dwelling
 Mean: 48,00

Integration

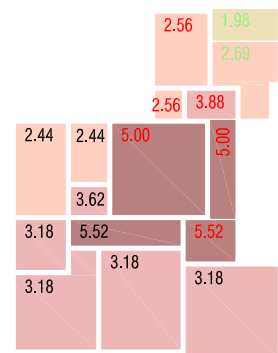

Entire dwelling
 Mean: 3,49



Obligatory rooms

- _ kitchen
- _ laundry
- _ double bedroom
- _ 2 single bedrooms
- _ separate or combined living room and dining room
- _ private bathroom (1st)
- _ private bathroom (2nd)
- _ guest bathroom
- _ storeroom

Extra divisions requested by the family (in order of priority) and relationships between divisions

- _ all bedrooms next to each other
- _ separated living and dining rooms
- _ dining room near kitchen
- _ living room near entrance
- _ 2 fully equipped private bathrooms
- _ isolated work area to serve as guest bedroom
- _ laundry area separate from kitchen

General characteristics

- _ Bedrooms and living rooms have natural light and ventilation
- _ The daytime area (living rooms + kitchens) can be separated from the night-time area (bedrooms and private bathrooms) by doors or a corridor

Social area

- _ The social area is accessed via the circulation areas
- _ The dining room and living room are combined or separate but adjacent, enabling them to be linked
- _ The dining room is close to the kitchen
- _ There is a bathroom for general use with easy access that does not involve passing through private or social areas
- _ Social spaces are close to the entrance for easy access
- _ The living room is large enough to allow for the possibility of installing furniture for viewing TV or home cinema from a distance of 3m
- _ There is individual access to the living room(s) via a circulation area or other living room
- _ All living rooms comply with minimum area requirements

Private area

- _ Bedrooms and private bathrooms are accessed from circulation areas other than those of the hall and the social and service zone circulation areas
- _ The bedrooms have access to a bathroom within the same private area
- _ All bedrooms comply with minimum area requirements

Service area

- _ The kitchen is accessed by circulation areas or via a living room, if it is not the only one
- _ The kitchen includes an eating area for light meals or is close to an eating area
- _ The kitchen includes a space for laundry work or has a direct link to a space reserved for this purpose
- _ The kitchen complies with minimum area requirements

Circulation areas

- _ There are at least one for alternative paths within the dwelling
- _ There are no obstacles to circulation within the social area
- _ There are no obstacles to circulation within the service area
- _ There are no obstacles to circulation within the private area

Demolition work

- _ Linear dimensions of walls demolished

derivation: integration of ICAT

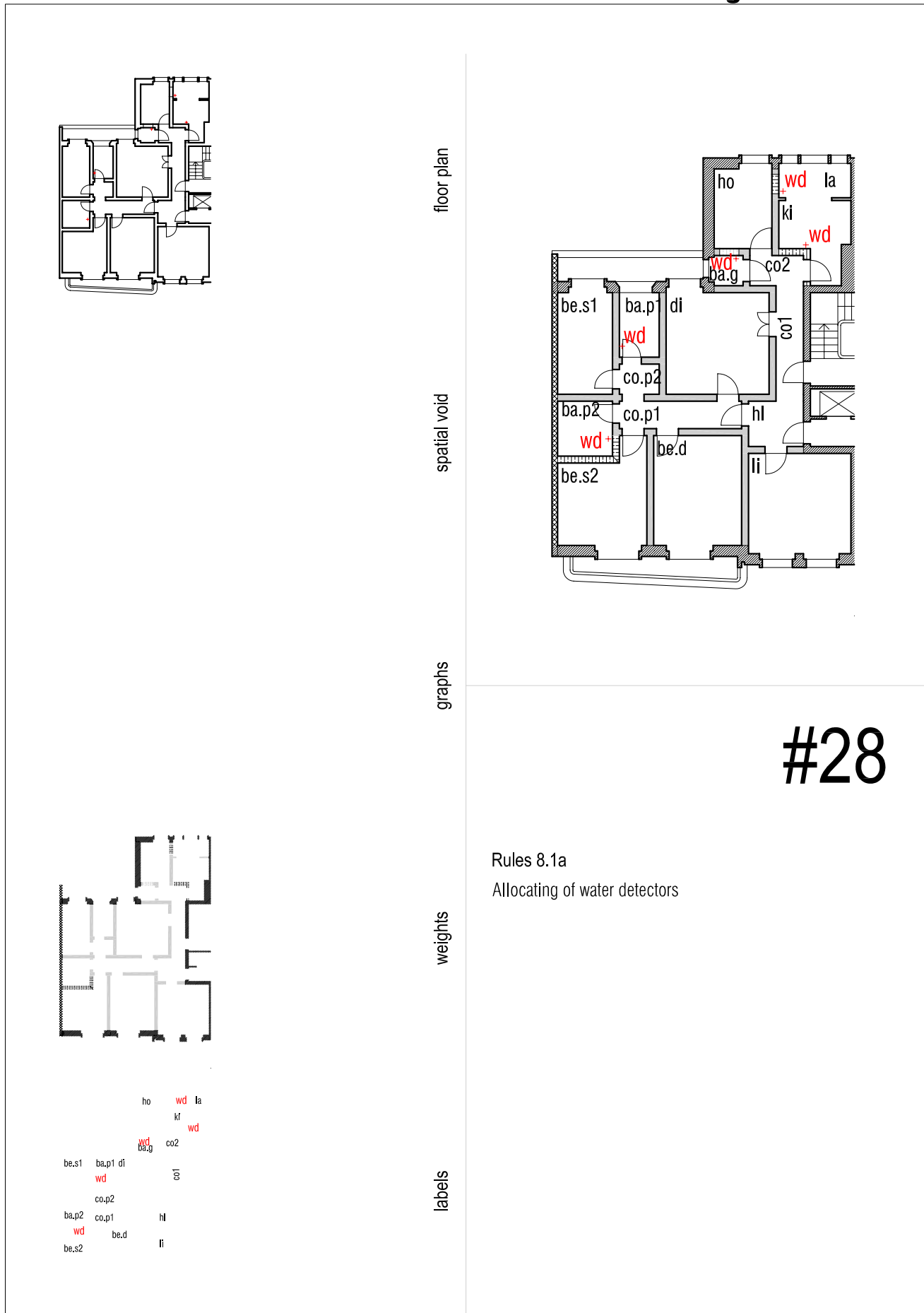

derivation: integration of ICAT

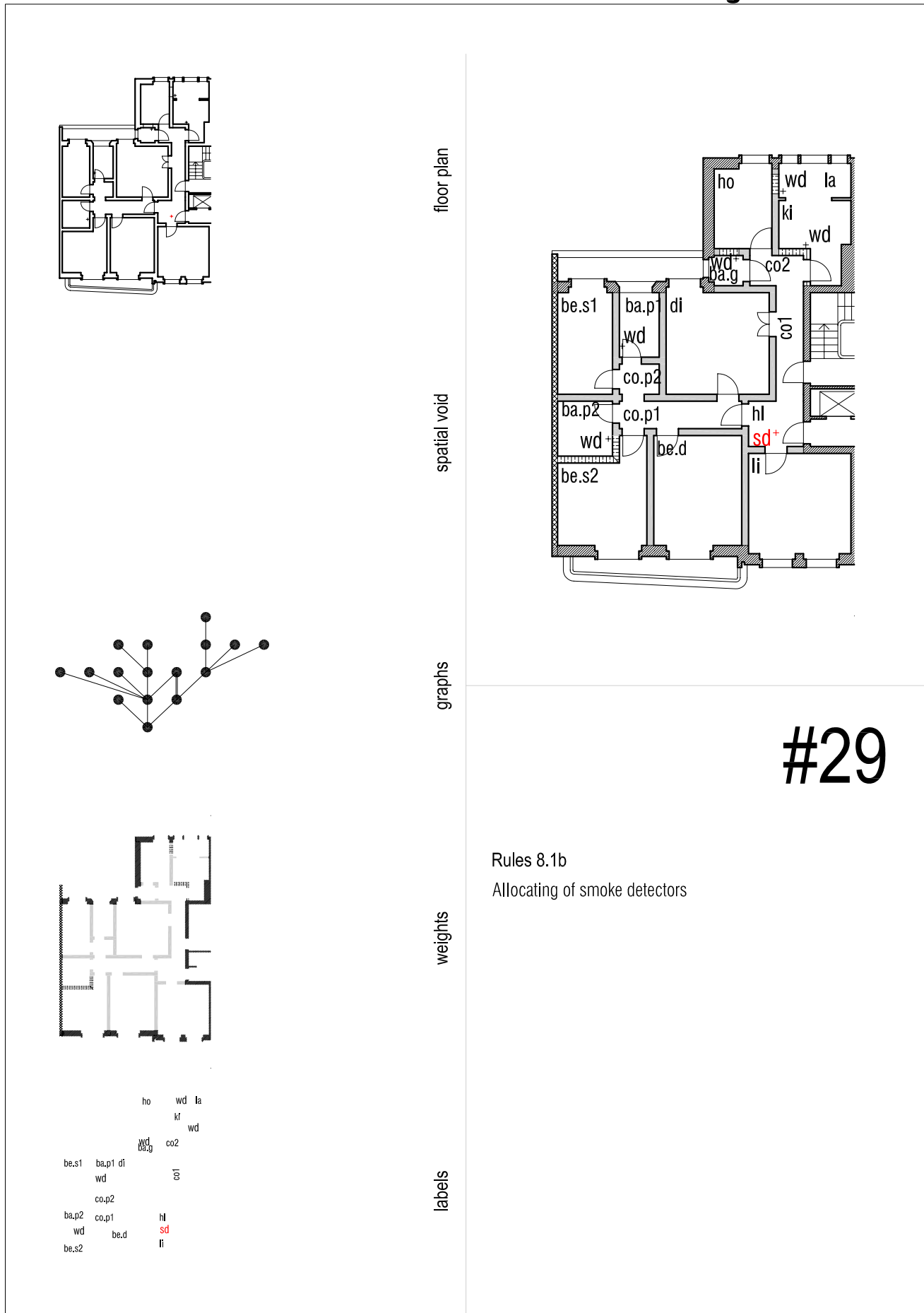

#29

Rules 8.1b
Allocating of smoke detectors

derivation: integration of ICAT

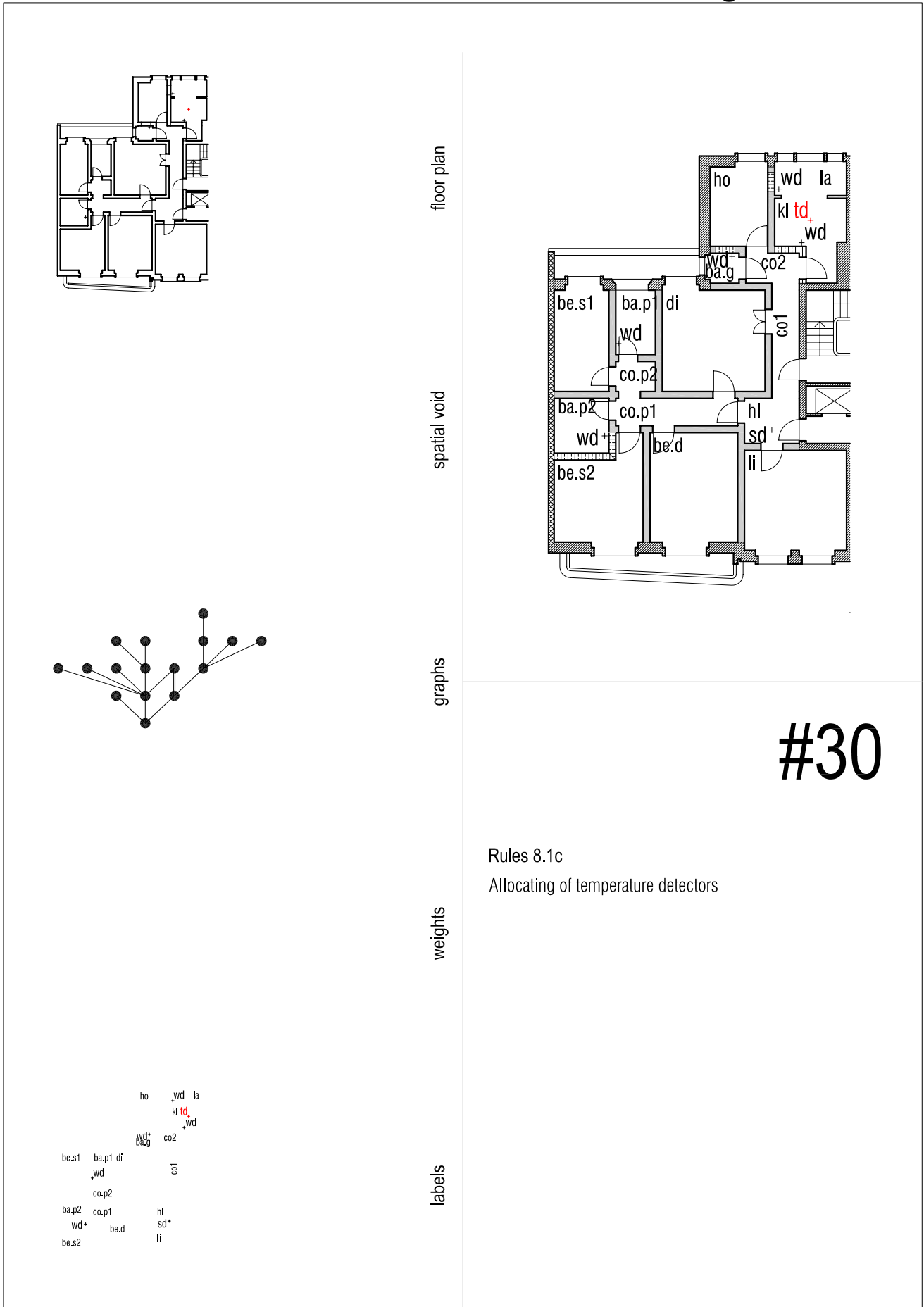

derivation: integration of ICAT

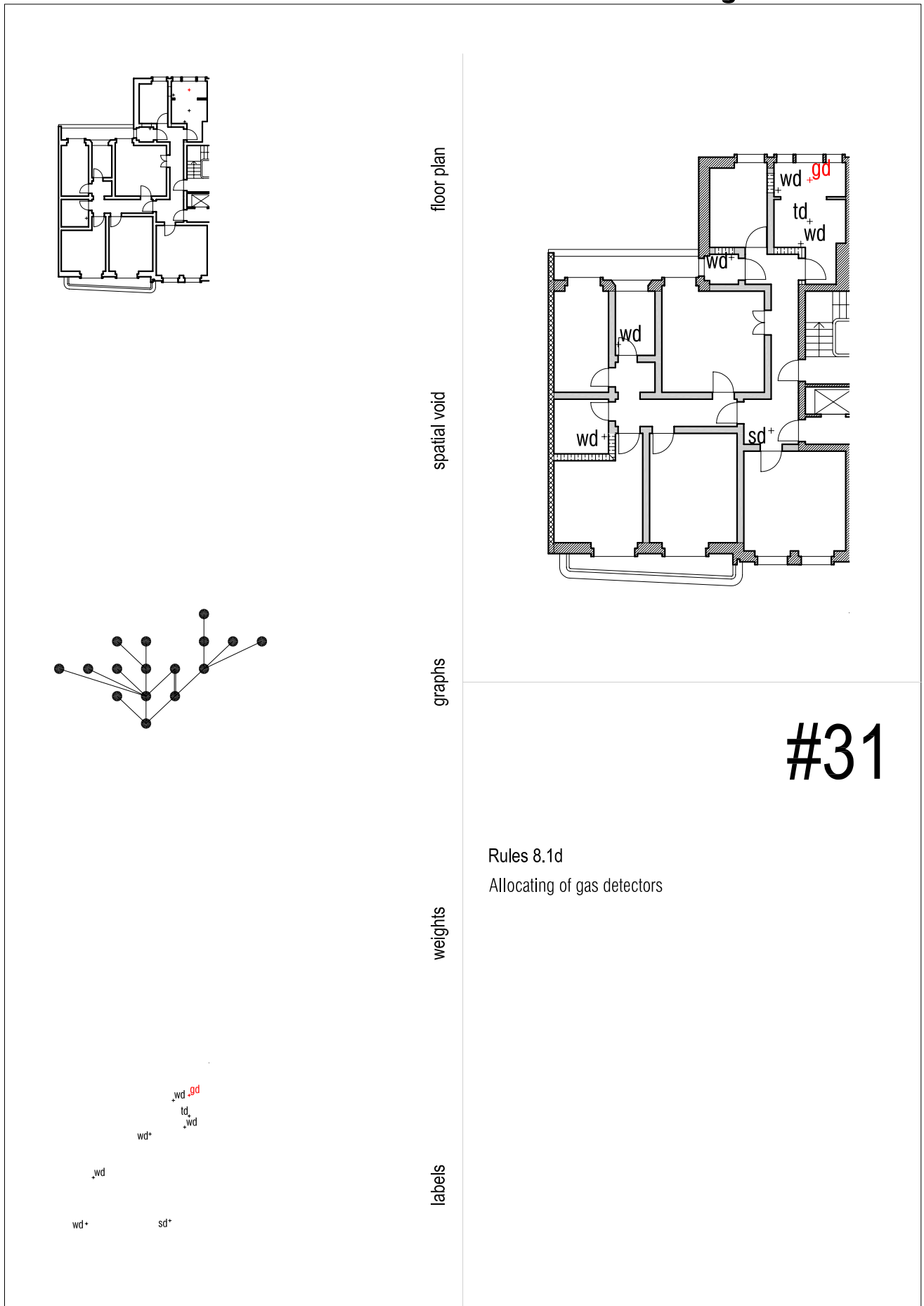

#31

Rules 8.1d
Allocating of gas detectors

derivation: integration of ICAT

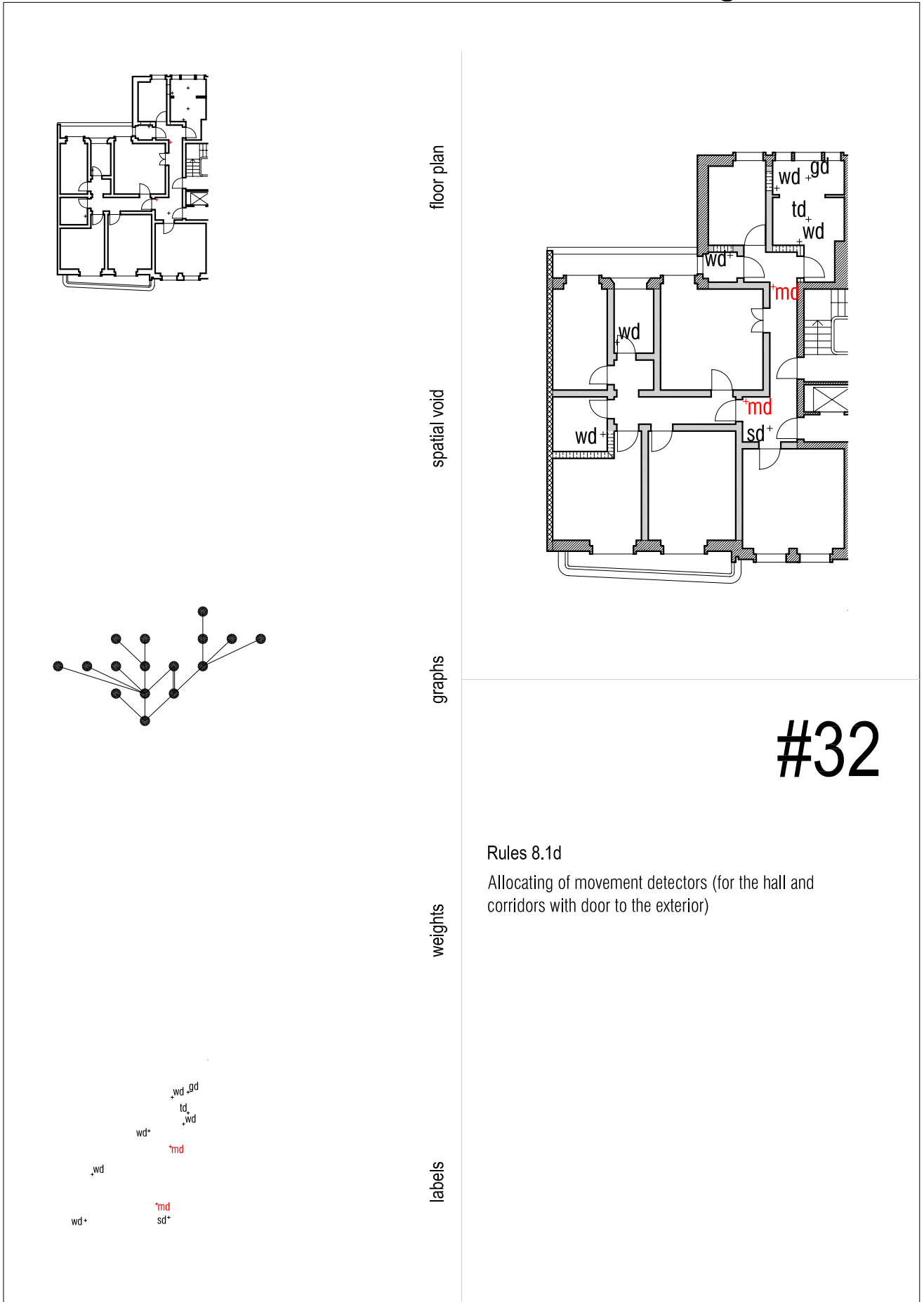

derivation: integration of ICAT

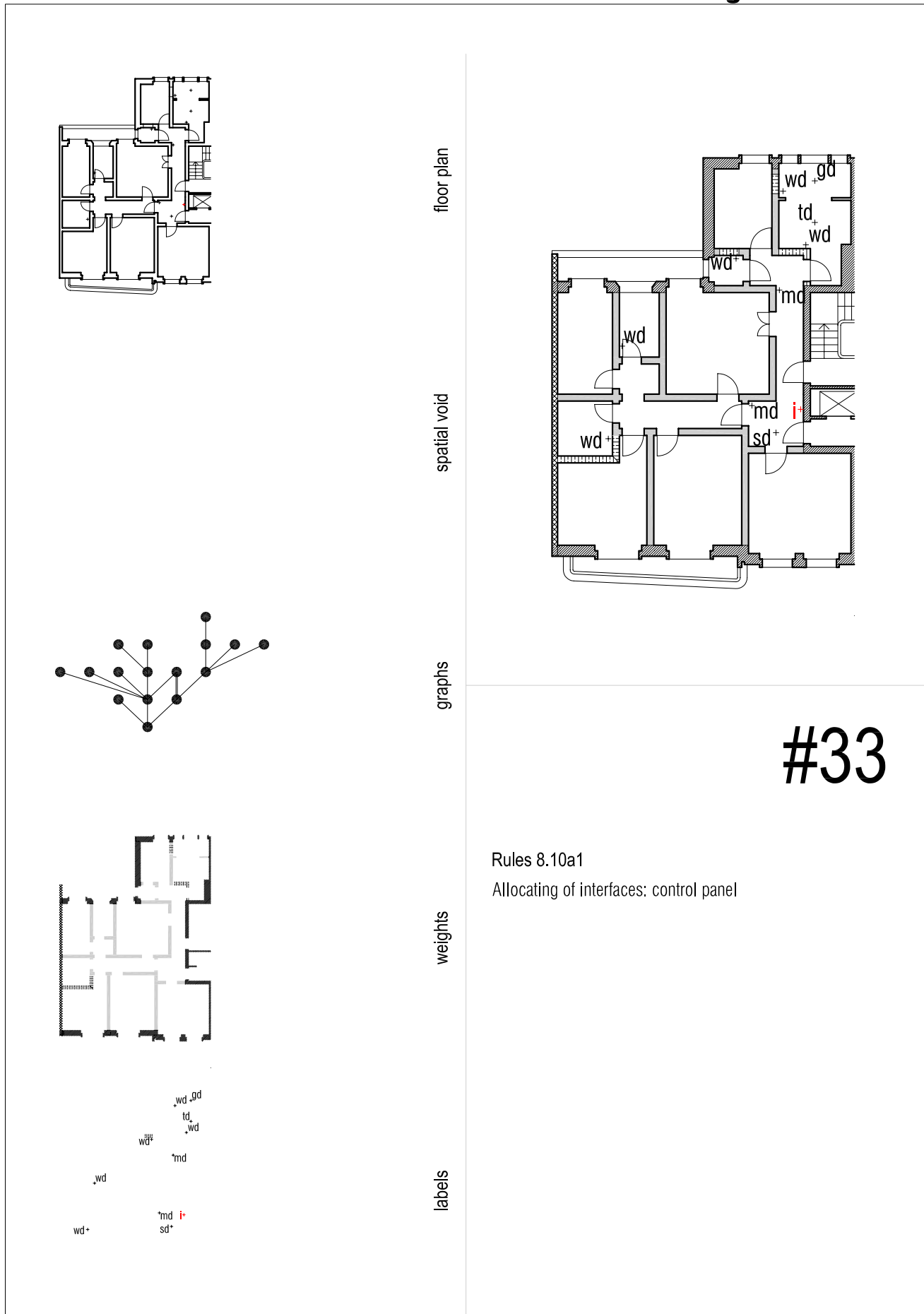

derivation: integration of ICAT

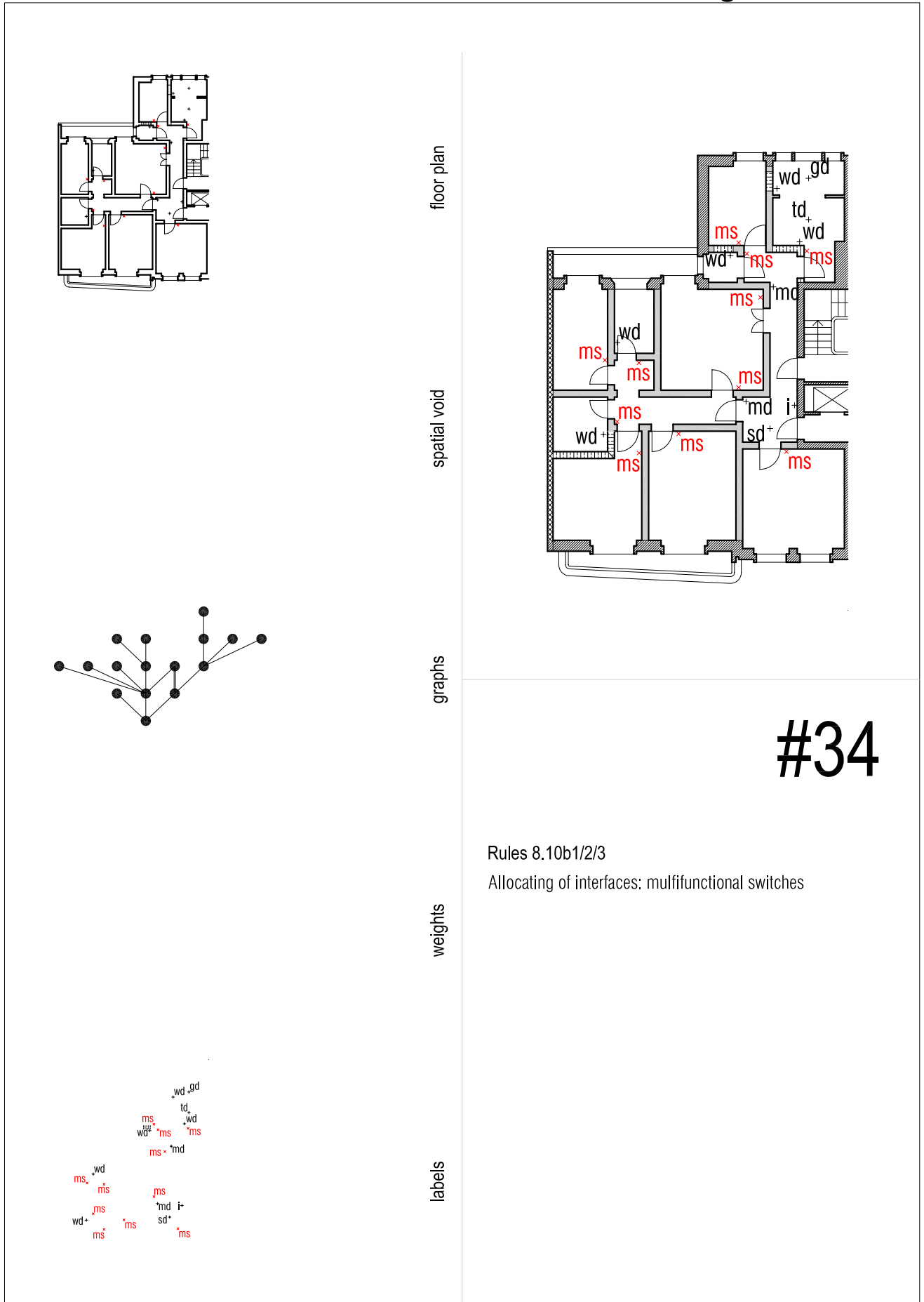

derivation: integration of ICAT

... final

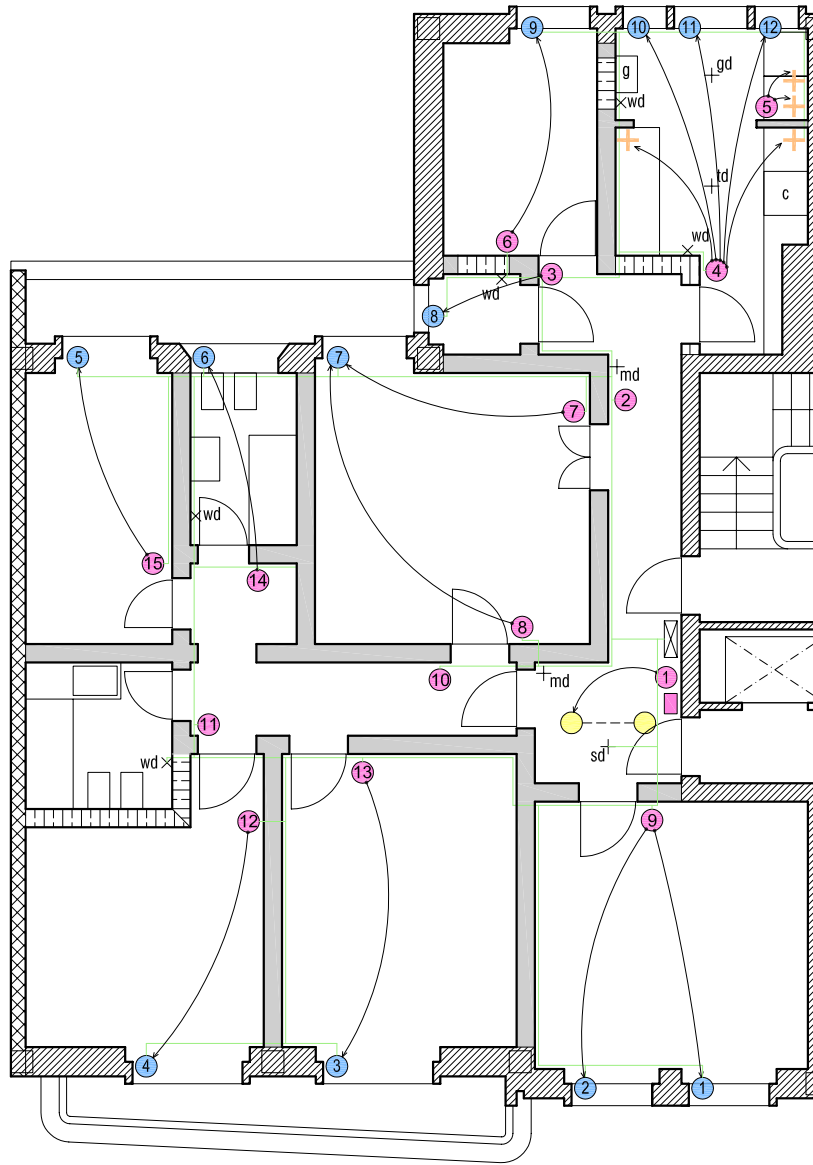

- Controlled blinds
- ⊕ Controlled sockets
- Multifunctional switches and entry modules
- Control panel
- ▨ Domotic cupboard
- Controlled lights
- Domotic controls
- Number of buttons on each control panel (e.g. 1 button)
- Two buttons
- Bus cable
- +sd Smoke detector
- ×wd Water detector
- +md Movement detector
- +td Temperature detector
- +gd Gas detector

The representation of the domotic system was adapted from (Teixeira, s.d.)



