

ASSEMBLY AND PREPARATION FOR THE DERIVATIVE
MARKET – A CONVENIENCE COMPARISON BETWEEN
FINANCIAL OPTIONS AND FUTURES WITH VIEW TO THE
EUREX AND LIFFE

Arne Neumann

Project submitted as partial requirement for the conferral of

Master in Finance

Supervisor:

Prof. João Pedro Vidal Nunes, ISCTE Business School, Finance Department

April 2011

Abstract – English

This dissertation conveys a swot-analysis of options and futures, partially based on their fundamentals as described in the appendices, with regards to their convenience for an entry. Further, this convenience comparison is reinforced with a view to two of the world's biggest derivative exchanges, Eurex and Liffe, and examines them in terms of their product lines, trading volume and transaction fees. All-encompassing, the analysis concludes that futures are the most convenient derivative for an entry on the derivative markets, which the analysis of two derivative exchanges substantiates. Additionally, Eurex slightly favours an entry with futures above Liffe, mainly due to higher trading volume and intercessional transaction fees. Apart from that neutral analysis, the studies of general information such as the comprehension of the market as well as price movements are basic prerequisites for an entry. This leads to the recommendable aspect that the convenience of futures need to be seen from a different angle under certain circumstances or scenarios such as personal preference, the level of risk-tolerance and personal wealth.

JEL Classification: Convenience, Options, Futures, Eurex, Liffe

F 39; G19

Abstract – Portuguese

Esta dissertação parte de uma análise SWOT de opções e futuros, parcialmente baseados nos seus fundamentos como estão descritos nos apêndices, tendo em conta a conveniência da sua entrada. Mais à frente, esta comparação de conveniência é reforçada com uma visão de duas das maiores bolsas de produtos derivados do mundo, Eurex e Liffe, e examina-as em termos das suas linhas de produto, volume de negócios e custos de transacção. Abrangendo tudo isto, a análise conclui que os futuros são os produtos derivados mais convenientes para uma entrada nos mercados de derivados. A Eurex favorece ligeiramente uma entrada com futuros, mais do que a Liffe, principalmente devido a um volume de negócios superior e a custos de transacção intermédios. Fora dessa análise neutra, os estudos de informação, a compreensão do mercado, bem como as flutuações dos preços são pré-requisitos básico para uma entrada. Isto leva-nos a um aspecto recomendável de que a conveniência de futuros devem ser vistos de um outro ponto de vista, noutras circunstâncias, ou cenários tais como, preferências pessoais , o nível de tolerância ao risco e riqueza pessoal.

JEL Classification: Conveniência, opções, futuros, Eurex, Liffe

F 39; G19

Acknowledgements

I would like to thank a number of people who helped me to support my dissertation.

Especially I am thanking Lennart Asthoff, Henning Rieke, Andreas Karle and Enrique Alejandro Collazos Contreras for affording the time to review my dissertation and who encouraged me to revise and improve parts of it.

Further, I am indebted to my friends, Martin Apel, Ana Teresa Bento, Silvia Vincente, Eduardo Novais, for the translation of my abstract in Portuguese, which would have been impossible without them.

Additionally, my gratitude goes to all professors at ISCTE that assisted me in obtaining knowledge about finance and all other relevant subjects throughout my time at ISCTE. My special thanks go to Prof. Jorge Agarez Medeiros for his creative thoughts that inspired me to develop this dissertation.

Besides, I want to thank my family and friends, who were always there, in good as in bad times, and listened to my ideas and problems.

At last, I would like to thank my supervisor Mr. João Pedro Vidal Nunes, who accompanied me during the development process and convinced me to write this dissertation.

Thank you all for your support.

Arne Neumann

18th of April 2011

Executive Summary

Options and futures are well-known and traded derivatives in the world, which trading volume increases every year further. Several financial institutions, companies and others make use of them and benefit of their capabilities.

Nonetheless, average persons as well as small- and medium-sized companies that do not bring along the knowledge, and esteem the financial derivative markets due to its complexity, are sceptic towards and entry. In the case they consider to enter the market, it poses the question which one is more convenient for an entry.

Therefore, this dissertation endeavours to present a SWOT-analysis of the two strongest derivatives in the world, financial options and futures, bringing the subject a bit closer and look at them in terms of their convenience for an entry. Seen from this angle, the convenience comparison between options and futures will be deepened with a look at the Eurex and the Liffe, also to determine, which of both markets provide an advantageous entry for trading, options or futures.

Within the framework of a case study, the overall purpose of the research was an exploratory study and the project followed an inductive approach. Results were determined by means of qualitative and quantitative data collection methods, which included mainly secondary resources such as books and the internet. Furthermore, as only a snap-shot was taken, the cross-sectional approach has been chosen.

The research conducted, imbedded in a swot-analysis, revealed that futures are more convenient than options. Although futures transmit a higher level of risk and require a commitment compared to options, they are less complex, easier to understand and do not lose value due to time decay.

With regards to other factors of options and futures, they convey in many respects equally considerable criteria such as their high leverage and the ability to hedge. Also, both can benefit from today's advanced technology in online trading; from exchange's volumes, products, rules & regulations; influential events and arbitrage opportunities. However, these can partially pose a threat as well.

The convenience of futures for an entry could be underpinned with a view to the product range, trading volume and transaction fees of the Eurex and the Liffe. A wide product range, high trading volumes (liquidity) and transaction fees that partially favour futures speak for an entry by futures.

In a direct comparison between Eurex and Liffe in terms of product range, trading volume and transaction fees, Eurex is a preferable choice over Liffe, mainly due to higher trading volumes and favourable transaction fees.

Apart from that, the dissertation points out the importance of comprehending the markets, by studying general information of the derivatives the markets, price movements and the impact of influencing incidents, because these are essential pre-requisites and can pose a significant threat to trading.

Finally, bearing these facts in mind, it is recommendable to reconsider the convenience of futures among certain scenarios again. Depending on the amount of wealth, the level of risk-tolerance as well as the personal penchant, options have to be reconsidered as a valuable alternative due the limited risk and the maximum loss in the amount of the premium.

Table of Contents

ABSTRACT – ENGLISH	II
ABSTRACT – PORTUGUESE	III
ACKNOWLEDGEMENTS	IV
EXECUTIVE SUMMARY	V
TABLE OF CONTENTS	VII
ABBREVIATION TABLE OF CONTENTS	IX
LIST OF TABLES	IX
LIST OF FIGURES	IX
1. INTRODUCTION	10
2. LITERATURE REVIEW	12
3. METHODOLOGY	14
3.1 INTRODUCTION	14
3.2 RESEARCH FRAMEWORK.....	14
3.2.1 <i>Research objective</i>	14
3.2.2 <i>Research questions & objectives</i>	15
3.3 RESEARCH DESIGN	18
3.3.1 <i>Research philosophy</i>	19
3.3.2 <i>Research approach</i>	20
3.3.3 <i>Research strategy</i>	20
3.3.4 <i>Time horizon</i>	21
3.4 DATA COLLECTION	21
3.5 INTERPRETATION OF FINDINGS.....	22
3.5.1 <i>Reliability and Validity</i>	22
3.6 LIMITATIONS AND CONSTRAINTS	23
4. SWOT-ANALYSIS OF OPTIONS & FUTURES.....	24
4.1 OPTIONS.....	24
4.1.1 <i>Strengths</i>	25
4.1.2 <i>Weaknesses</i>	26
4.1.3 <i>Opportunities</i>	28
4.1.4 <i>Threats</i>	30
4.2 FUTURES.....	32
4.2.1 <i>Strengths</i>	32
4.2.2 <i>Weaknesses</i>	34
4.2.3 <i>Opportunities</i>	35
4.2.4 <i>Threats</i>	35
5. COMPREHENDING THE MARKET.....	37
5.1 BACKGROUND INFORMATION.....	37
5.2 INFLUENCING EVENTS	38
6. EUREX	41
6.1 PRODUCTS	41

- 6.2 LIQUIDITY OF CONTRACTS (TRADING VOLUME)..... 44
- 6.3 TRADING COSTS & FEES..... 46
 - 6.3.1 Order Book & Wholesale Trading 50
 - 6.3.2 Volume rebates..... 50
 - 6.3.3 Transaction fees – Options vs. futures..... 51
- 7. LIFFE 52**
 - 7.1 NYSE LIFFE..... 52
 - 7.2 PRODUCT RANGE 53
 - 7.3 TRADING VOLUMES 55
 - 7.4 TRADING FEES..... 58
 - 7.4.1 – Rebates 62
 - 7.4.2 – Transaction fees options vs. futures 62
- 8. CONCLUSION 64**
- 9. RECOMMENDATIONS 66**
 - 9.1 CRITICAL REFLECTIONS 67
- 10. BIBLIOGRAPHY 69**
 - 10.1 BOOKS 69
 - 10.2 WEBSITES 70
- APPENDICES 71**

Abbreviation Table of Contents

FI	= Financial Institution
OTC	= Over-The-Counter
ITM	= In-the-money
ATM	= At-the-money
OTM	= Out-of-the-money
APR	= Annual Percentage Rate
BS	= Black Scholes
EUREX	= European Derivative Exchange
DTB	= Deutsche Börse AG
SOFFEX	= Swiss Options & Financial Futures Exchange
LIFFE	= London International Financial Futures and Options Exchange
EEX	= European Energy Exchange
ISE	= International Securities Exchange
SMP	= Skimmed Milk Powder
ETF	= Exchange Traded Funds
STIR	= Short-term Interest Rate
MSCI	= Morgan Stanley Capital International

List of Tables

TABLE 1 – GLOBAL TRADING VOLUME 2009-2010	10
TABLE 2 – RESEARCH QUESTIONS & OBJECTIVES.....	18
TABLE 3 – EUREX TOTAL TRADING VOLUME 2006 – 2010	44
TABLE 4 – EXAMPLE STANDARD & REDUCED FEE AT EUREX.....	49
TABLE 5 – LIFFE TRADING VOLUME 2006 - 2010.....	56

List of Figures

FIGURE 1 – OVERVIEW PROJECT, MAIN QUESTIONS AND ESTABLISHMENT.....	15
FIGURE 2 – THE LITERATURE REVIEW PROCESS	16
FIGURE 3 – RESEARCH UNION BY SAUNDERS.....	19
FIGURE 4 – SWOT-ANALYSIS OPTIONS	24
FIGURE 5 – SWOT-ANALYSIS FUTURES	32
FIGURE 6 – EUREX TRADING VOLUME 2006-2010 STACKED BAR CHART.....	45
FIGURE 7 – EUREX TRADING DISTRIBUTION BY OPTIONS AND FUTURES	46
FIGURE 8 – LIFFE TRADING VOLUME 2006 – 2010 STACKED BAR CHART	56
FIGURE 9 – LIFFE TRADING VOLUME PER SEGMENT 2010 PIE CHART ⁹²	57
FIGURE 10 – LIFFE TRADING VOLUME DISTRIBUTION BY OPTIONS AND FUTURES.....	58

1. Introduction

The financial derivative world remains unattainable for many such as the average-person and small- to medium-sized companies, because of limited capital, partially missing expertise, and complex and complicated terms that hamper the comprehension. Consequently, some are awed by the financial expert domain and fear to encounter disappointments when commencing to trade on the markets.

Nowadays, mainly large clients such as hedge funds, trading institutions, investment banks, big corporations or individual investors, with large financial capabilities and the expertise, participate on the market and using two of the biggest derivatives such as options and futures and benefit from their capabilities to hedge, speculate and arbitrage.¹

Global Listed Derivatives Volume (in million contracts)		
	2009	2010
Futures	8,188	11,182
Options	9,556	11,112
Total	17,744	22,295

Table 1 – Global trading volume 2009-2010²

In case of getting involved and benefit from options and futures as well, it poses the question which one is more convenient for an entry on the markets?

Thereby, this dissertation endeavours to bring the subject of financial options and futures to those that have little to no knowledge about them, a bit closer. They will be directly compared and analysed in terms of their convenience for an entry by examining their strengths and weaknesses with regard to two of the biggest derivative markets, the Eurex and the Liffe, whereat the following questions will be addressed:

- What are the strengths, weaknesses, opportunities and threats of financial options and futures?

¹ <http://www.economywatch.com/market/derivative-market/meaning-derivative-market.html> (02-03-11)

<http://business.mapsofindia.com/investment-industry/participants-and-functions-in-derivatives.html> (02-03-11)

² http://www.futuresindustry.org/downloads/Volume-Mar_FI%28R%29.pdf (13-04-11)

- Which one is preferable/convenient to use for an entry on the markets?
- Based on the convenience for an entry, which derivative (options or futures) favour Eurex and Liffe
- Which derivative market (Eurex/Liffe) tenders more performance (product range, trading volume, trading fees)?

The dissertation will comprise basics of financial options and futures in the appendices, partially as a reference point in order to comprehend parts of the swot-analysis of the options and futures, which are explained after the methodical reflection that imparts research steps and procedures how the dissertation came about.

Before the swot-analysis of financial options and futures will be substantiated through the specific analysis of Eurex and Liffe in terms of product range, trading volume and transaction fees, an introduction on derivative markets and the importance of information will be given, which is enrooted in several parts of the dissertation.

At last, a conclusion is drawn upon the swot-analysis of financial options and futures and the outcome of the Eurex and Liffe, determining which derivative is more convenience and which market is preferable for an entry.

2. Literature Review

The main idea for this dissertation emerged during studies. After having obtained partially first knowledge about the fundamentals of derivatives such as options and futures, it posed the question if this knowledge is capable of carrying it forward to the derivative market and be able to trade and speculate.

This focus of interest formed a narrow direction. In this context it queries, which derivative (options or futures) is more convenient to use as well as to enter the market for someone with the basic comprehension. Also, further question came up such as: which derivative markets exist?; how to enter?; what to consider?; if starting to trade, what would be the next steps?

Bearing these ideas and perceptions in mind, opened the idea of a preparation and assembly for financial options and futures to enter the market. In collaboration with Professor João Pedro Vidal Nunes, the idea was specified as a convenience comparison between both derivatives in terms of entering the market. In order to specify the subject further, the convenience comparison should be concretised by a view to the EUREX and the LIFFE, especially in terms of the product range, trading volume and transaction fees for options and futures.

Research had shown that almost no studies or works focused on a direct comparison between options and futures not to mention with a look at derivative markets. Myriads books and internet sources showed and explained the fundamentals of options and futures as publications of John C. Hull (2005) or W. Edward Olmstead (2006). However, none of them directly compares options and futures in terms of their convenience and recommends based on that which one to use for entering the market.

Further, such convenience comparison had not been done in such a composition before, especially by substantial analysis through derivative markets. Researches such as of Matthias S. Riechert (2006) contain fundamentals of options and futures and partially approach how to enter the Eurex, but do not highlight one of them for an entry nor specialise on aspects such as liquidity and transaction fees. Also, researches for comparable essays or dissertations in <http://papers.ssrn.com/> and <http://ideas.repec.org> did not reveal anything close that covered the idea or appeared to be useful.

A methodical approach was applied in order to deal with this whole idea and identify the sections for the main body. All section created built upon each other. Though, it was crucial to compose a little summary or provide at least some relevant information about financial options and futures before constituting any comparison, but also before dwelling on the Eurex and the Liffe, which enhanced the convenience perspective.

For the elaboration of the different sections merely secondary data had been used such as books and the internet, which provided enough information for most of the parts enough. However, the creation of the reference foundation as well as the swot-analysis for financial options and futures was very difficult and tedious to find some common ground, because of discrepancies in terms of reliability. This had to do with the point of view and the target group to which these resources tend to address.

Nonetheless, the convenience analysis of financial options and futures gives a direct comparison, which books and websites only partially constitute. Further, the view to the Eurex and the Liffe, provides a good foundation to understand options, futures and derivative markets. Of course, the view on derivative markets can be extended by additional ones to reinforce the convenience comparison as well as to evaluate them among each other. After all, the analysis of derivative markets can be amplified by factors such as become a member, entry requirements, accessibility, services, and other factors, which facilitate the decision for an entry.

3. Methodology

3.1 Introduction

This chapter provides a compilation of all necessary researches and approaches that were used to accomplish the dissertation. Before commencing with the actual work, some respective research needed to be induced to investigate the proper information and to establish an organizational framework as well as the underlying principles.

Firstly, the research framework clarifies the purpose and objective of the research, followed by an overview about the sub-research-questions that supports the main topic.

Secondly, the research design provides insight into the approaches, strategies and time horizon of the research.

Thirdly, the data collection chapter presents the data, which has been used to establish the basics, the comparison of financial options as well as the view on the Eurex and Liffe.

At last, the interpretation of findings address the validity and reliability of the dissertation content followed by the limitations and constraints of the research, concluding the methodology.

3.2 Research framework

3.2.1 Research objective

The objective is one of the most important foundations of the research. As already instructed in the introduction and in the literature review, the main idea was to establish some conception of preparation and assembly to enter the derivative market. The final topic was with the help of Professor João Pedro Vidal Nunes from the ISCTE-IUL elaborated and specified. These refinements accentuated the idea of the preparation and assembly as the analysis of financial options and futures in terms of their convenience for an entry. This was supported by the analysis of the Eurex and the Liffe in terms of product range, trading volume and transaction fees, while simultaneously making a convenience comparison among them.

Since, a comparison for all the derivatives would have been too broad, they were narrowed down to options and futures. Furthermore, two derivative markets, Eurex and Liffe, were appended in order to provide an additional perspective of the two derivatives.

Firstly, a coarse structure helped to get an overview about the different steps and parts of the dissertation. As in a preparation and assembly it was necessary to study and dispose the materials and data, before proceeding to the next stage. In this manner, the main research focussed on obtaining all resources that contained information for all three parts and filter them according to the respective section, whereas the basics were placed in the appendices to severe as a reference. The figure below adumbrates how the sections relate and build upon each other.

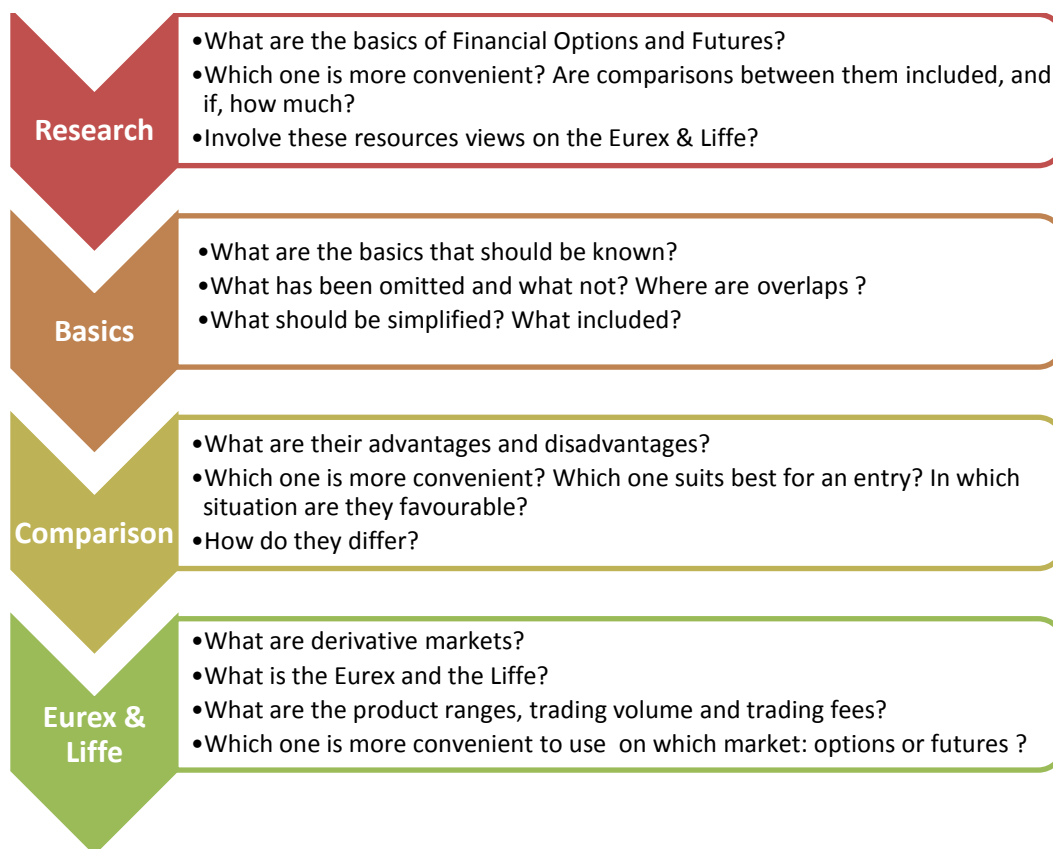

Figure 1 – Overview Project, Main Questions and Establishment

3.2.2 Research questions & objectives

Since the dissertation was a theoretical concept rather than a practical study, the subordinated questions that had been developed served more as a guide through the dissertation. These subsequent questions arose through a spiral effect, partly equivalent to the steps and procedures of the literature review. The literature review process as described below, depicts the review and assessment of substantive findings and the own knowledge with every addenda of literature and data. New perceptions and additional points of view were not excludable. As

soon as more knowledge had been gathered about the subject, new questions arose naturally, putting into question the newly elaborated parts and elements.

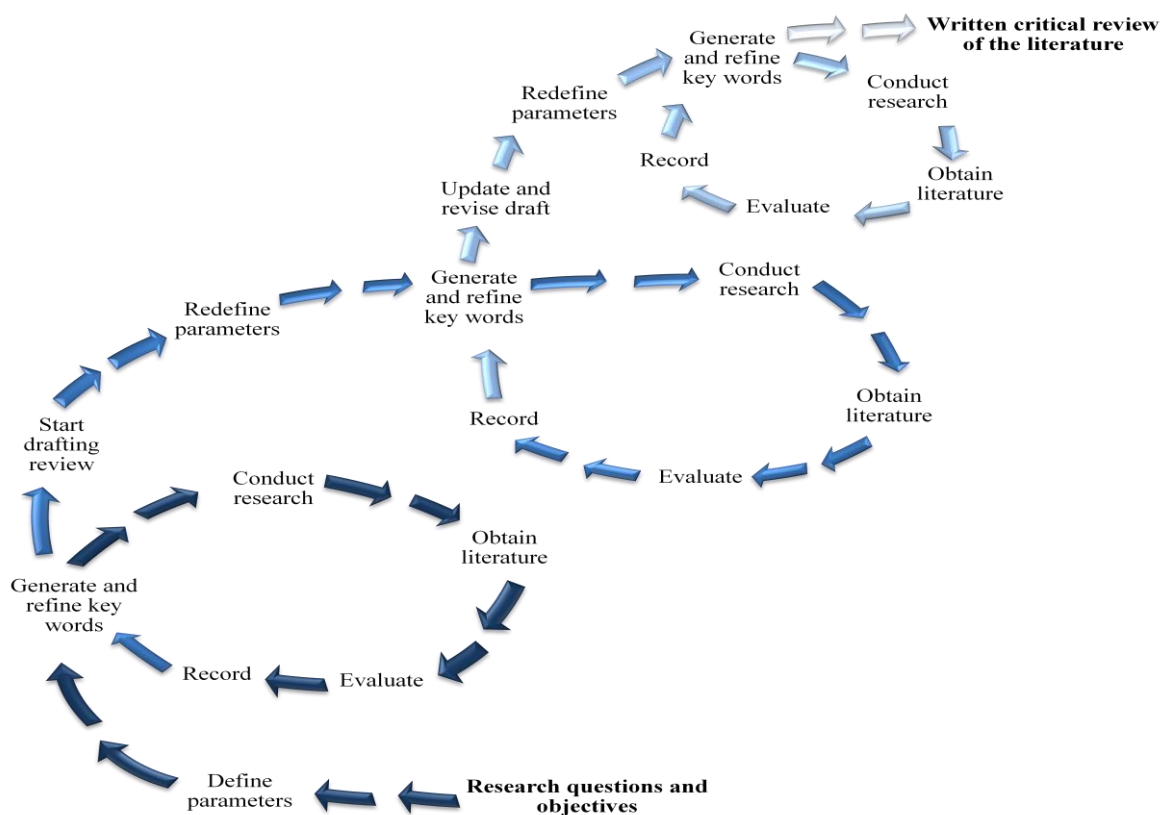

Figure 2 – The literature review process³

The circle process not only qualified the elaboration of subordinated questions as well as the literature review, but also was applicable to the continuous amendment of the content. With further reading and studying, the comprehension of the subject grew, which allowed additional perspectives and perceptions that might need to be evaluated and included.

Additionally, after the main research question had been stated, secondary research questions were developed to frame the main sections and maintain a direction. Most of the sub questions emerged from the reviews of secondary data or derived from the main research questions.

³ M.Saunders, P. Lewis, A. Thornhill, 2003, *Research Methods for Business Students*, 3rd edition: Prentice Hall [page 45]

Every research question was an objective assigned. However, some question did not need an objective, because they were self-explanatory. The table with the research questions was divided into the respective sections as the colours point out.

Since, the research followed an inductive approach⁴ amendments occurred until the very end, which did not exclude that some question could come up very late, while others had to be removed. Accordingly, not all questions could be collected and compassed during the whole process due to the dissertations complexity and dimension.

Research Question	Research Objective
Research	
What are the basics of financial options & futures	To establish the fundamental for the comparison
What data provide sources?	To find the most adequate data
What are advantages and disadvantages of options and futures	To look for such information in the obtained sources as well
Are comparison between Options and Futures shown?	If available, to which extend they are useful
Involve these resources information about Eurex & Liffe?	To keep an eye on such information as well
Options and futures view on Eurex & Liffe?	To find indications for the Eurex & Liffe view
Basics Financial Options & Futures	
What are FO/Futures?	To bring out their basics
How do they work?	To explain how they function
How are basics presented?	To structure them appropriately and implement simplifications
What should be included?	To omit unnecessary and have sufficient to build a comparison upon
What strategies should be included?	To not deluge the basics with too many
Convenience Comparison	
What are the strengths and weaknesses?	To precisely narrow down their pros and cons
What are the opportunities and threats?	To identify external factors that support or pose a threat
How do they differ?	To identify significant differences
Which one is advisable to use for a start?	To spot the best one for an entry
Restrictions and constraints?	Can help to find disadvantages
How to compare options and	To prepare an acceptable overview

⁴ See Chapter 3.3.2 Research approach

futures?	
Which one is more convenient?	To identify the convenient one
What influences the convenience	To recognize factors that might modify the conclusion
Eurex & Liffe	
What is Eurex & Liffe?	To find about their history for an introduction
What is their product range?	To identify all option and future products
What is the trading volume?	To recognize trends of options and futures as well as for the two derivative markets
What are the transaction fees?	To spotify the different fees Eurex and Liffe charge for trading
Which one has better offers?	In terms of product range, higher liquidity'?
Which suits better to enter: options and futures?	To check, which instruments is more convenient to trade on both markets
Which market is preferable? (Eurex Liffe?)	For the final view, considering pros and cons of options and futures

Table 2 – Research Questions & Objectives

3.3 Research design

Prior to the actual investigation, a research design was created, involving amongst others, a research approach and strategy in order to obtain optimal data and ensure a smooth development.

The idea of the “Research process onion”⁵, which starts by the outer circle and ends with the inner one, helped to define a proper research concept to lead through the research processes. Nonetheless, the research design underlies one of three different types of studies, which are the exploratory, the descriptive or the explanatory study.

All three differ by its objectives. According to Saunders (2003, 96-98), these would be: “finding out what is happening: seek new insights; ask questions and to asses phenomena in a new light; portray an accurate profile of persons, events or situations; and studying a problem in order to explain the relationship between two variables”.⁶

⁵ M.Saunders, P. Lewis, A. Thornhill, 2003, *Research Methods for Business Students*, 3rd edition: Prentice Hall [page 83]

⁶ M.Saunders, P. Lewis, A. Thornhill, 2003, *Research Methods for Business Students*, 3rd edition: Prentice Hall [page 96-98]

As a result, this research could be described as an “Exploratory study” with the purpose to find and present partially a new insight by making a convenience comparison between financial options and futures in terms of an entry with a supportive and recommendable view on the Eurex and the Liffe.

An exploratory research includes three elements of conducting, whereas the main focus was on the literature search:

- A search of the literature,
- Talking to experts in the subject,
- Conducting focus group interviews⁷

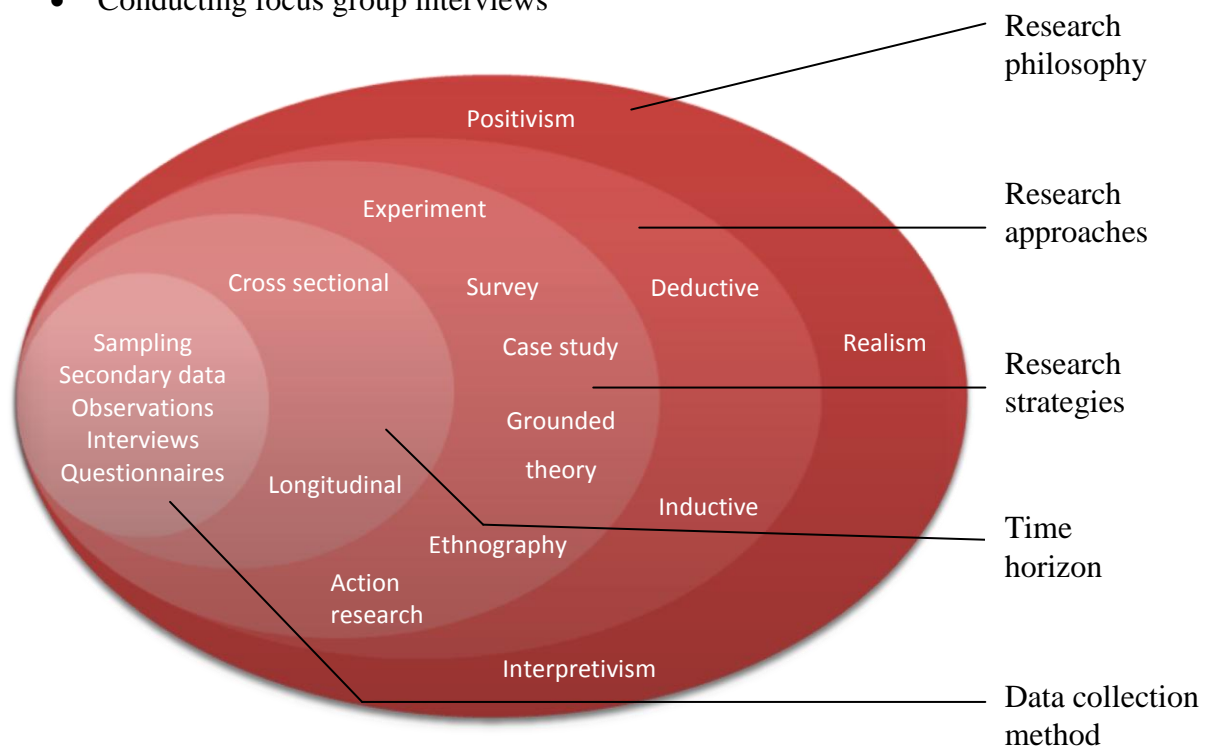

Figure 3 – Research Onion by Saunders

3.3.1 Research philosophy

The research philosophy partly appointed the fundamentals for the whole research. However, the weighting was small compared to the entire research design, since it conveyed merely a philosophical perception of the research.

After the determination of the research study, the research philosophy was defined, which implied a little combination of interpretivism and realism. Possibly, the strongest arguments

⁷ M.Saunders, P. Lewis, A. Thornhill, 2003, *Research Methods for Business Students*, 3rd edition: Prentice Hall [page 97]

that accompanied these idealisms were the less law-generalised interpretations of findings that affect people's and others actions as well as the concept of realism that the reality emanates from an objective nature and is independent of human beliefs and thoughts.⁸

3.3.2 Research approach

With regard to the research study and the dissertation topic, which was formulated prior to the research, the research followed an inductive approach. Aspects of such an inductive approach included, possess a flexible structure and allow changes of the research as it advances. A theory can be developed after data has been collected and observed.

A general conclusion or theory, whether options or futures are more convenient for an entry could only be drawn after the analysis of the data.

Additionally, the less rigid research design of the inductive approach was more open to alternative changes of research as well as for sub-questions that arose during the elaboration and research process.⁹

3.3.3 Research strategy

Through the prior established approach, the philosophy and the type of studies, the grounded theory suited to be best as the research strategy. The grounded theory embodies the approach of gathering data, reading and re-reading until the most relevant has been found. This proved to be useful, since the various books and sources needed to be searched for different information a few times.

Further, for the grounded theory a disaggregation of data was added in form of an open coding. The main parts of the dissertation served as categories in form of key words in which books and sources that were assumed to be relevant could be placed.

Other strategies such as experiment, survey, case study, ethnography and action research did not apply as a research strategy, because they are strongly tied to primary data, the deductive

⁸ M.Saunders, P. Lewis, A. Thornhill, 2003, *Research Methods for Business Students*, 3rd edition: Prentice Hall [page 83-85]

⁹ M.Saunders, P. Lewis, A. Thornhill, 2003, *Research Methods for Business Students*, 3rd edition: Prentice Hall [page 85-88]

research approach or simply did not serve to be appropriate in order to answer the research questions.¹⁰

3.3.4 Time horizon

In compliance with the previous parts of the research design, the time horizon was clearly defined as cross-sectional. Longitudinal studies require the study and observation of changes and developments over a specific time period. Moreover, ISCTE constrained the timeframe of the dissertation, which was limited to ten month. This inevitably excludes the option of longitudinal studies. The cross-sectional studies, also known as a “snapshot approach”, mostly employ a survey strategy. However, merely secondary data was used as in the subsequent chapter explained.¹¹

3.4 Data collection

The core of the research process was the data collection method that in this case could be identified beforehand. Data collection was mainly provided through secondary data. Predominantly, books as well as the internet served as an adequate reference to establish the theoretical fundamentals of financial options and futures, to work out a swot-analysis and find appropriate data for the respective analysis of the product range, trading volume and the transaction fees about the Eurex and the Liffe.

Obviously, a survey or an observation would not have helped to find the basics about financial options and futures or obtain information about the Eurex and the Liffe. A conduction of primary data might have revealed the strengths and weaknesses of options and futures for the swot-analysis, but that was considered as to time-consuming and costly.

Nonetheless, through the inductive approach it was not excludable that other data collection types might be necessary with the further progress of the dissertation.¹²

¹⁰ M.Saunders, P. Lewis, A. Thornhill, 2003, *Research Methods for Business Students*, 3rd edition: Prentice Hall [page 90-95 + 398-400]

¹¹ M.Saunders, P. Lewis, A. Thornhill, 2003, *Research Methods for Business Students*, 3rd edition: Prentice Hall [page 95]

¹² M.Saunders, P. Lewis, A. Thornhill, 2003, *Research Methods for Business Students*, 3rd edition: Prentice Hall [page 190]

3.5 Interpretation of findings

During the research and the reading through numerous resources, it was important to distinguish between the findings. The aggregations in the books, for instance, may have met the requirements of the research, but some of them were not appropriate anymore. During the re-reading processes, it could be noticed that some information deviated due to different publishing years or due to a different comprehension level that was addressed. This complicated the combination of information and data. Also, the swot-analysis of options and futures was very arduous. Furthermore, sometimes the comprehension hampered the progress to express concepts and figures in an easy, clear, and understandable way as well as maintaining a level of clarity and accuracy.

3.5.1 Reliability and Validity

In terms of reliability and validity it was important to consider that most of the secondary sources used to elaborate the dissertation involved subjective bias. Books and internet resources reflected other's point of view and perceptions about financial options and futures. Moreover, it was tried to find intersections in order to avoid such subjective bias and entail a sense of objectivity. Also, it confirmed the rejection of primary data collection, which would have been biased as well. However, the value of a primary data such as interviews with experts in the field could have contributed to the final result and assessment of options and futures in terms of their convenience for an entry.

On the other hand, the analysis of the two derivative markets, Eurex and Liffe, could pass under an objective viewpoint, since mostly statistics and numerical data were analysed.

The outcome of the dissertation can be, as the inductive approach indicates, generalised. As long as the fundamental strengths and weaknesses of options and futures not change, the convenience comparison will remain. However, data of the Eurex and Liffe might change over time, which also affects the substantiated aspect of their analysis as well as the comparison among each other.

3.6 Limitations and constraints

In accordance with the standards and requirements of the ISCTE-IUL, some of the proposed main content, needed to be displaced into appendices to cover and maintain the maximum of 75 pages. Additionally, a continuous amendment throughout the dissertation persisted due to advancing in the subject as well as through the inductive approach, which reduced the timeframe for carrying out the project.

Similarly, time and money constrained the possibility of applying primary data. Interviews or a survey would have required participants from different nations as well as from different exchanges worldwide in order to have some useful and representative outcomes.

Also, the basic part about financial options and futures could have been amplified ad infinitum in order to support the convenience comparison between options and futures as well as the extension by the Eurex and Liffe. This would have required a lot more time to study and elaborate the materials.

However, the accessibility and procurement, especially for books, was difficult and costly. Libraries, with English or relevant books or documentaries, were complicated to access, because the respective information were not available or the access was prohibited.

4. SWOT-Analysis of options & futures

Options and futures are two different derivative instruments and both with their respective characteristics.

The following section comprises a SWOT-analysis that identifies the strengths, weaknesses, opportunities and threats of financial options and futures in order to evaluate their convenience for a market entry.

4.1 Options

Options implicate a variety of advantages and disadvantages that open opportunities as well as threats. Analysing these factors will help to understand options better and make it more comparable to futures in terms of their convenience.

	Positive	Negative
Internal Factors	Strengths S <ul style="list-style-type: none"> • High leverage • Limited Risk • Assessable profits and losses • Flexibility • No obligations 	Weaknesses W <ul style="list-style-type: none"> • Leverage • Complexity • Difficult to determine fair value • Commissions • Time decay • No voting rights (stock options)
External Factors	Opportunities O <ul style="list-style-type: none"> • Hedging • Online trading • Exotic options • Exchange market's volumes, products • Information & Research • Arbitrage • Influencing events 	Threats T <ul style="list-style-type: none"> • Influencing events • Liquidity • Volatility • Exchange's rules and regulations

Figure 4 – Swot-Analysis Options

4.1.1 Strengths

Options give investors high leverage. Instead of buying a certain amount of shares, it can be invested in an option contracts to hold a much higher amount of stocks. For example, for an amount € 2,000 100 shares of company ABC can be bought, but for an option price of € 4, the same amount of shares can be held through options. With one option contract (€4 x 100 shares = € 400) 100 shares of ABC can be controlled for just a fifth of the value. Consequently, with € 400 may not even be the same number of shares purchased. In case the option contract runs in the money, the investor can benefit five times as much as direct investment in the underlying stock. Correspondingly, the leverage effect allows with a small capital investment to elevate profits until infinity.¹³

One main factor that distinguishes options from futures is the level of risk. Options are a risk-reduced and a profit maximizing tool, while futures do not reduce risk, but are like options, highly leveraged. Some option positions and strategies were designed to limit risk. Also, due to their composition the maximum loss can easily be pre-determined, which is mostly the premium paid for the option.

In the end, knowing about the maximum loss, even if it can be unlimited, gives the investor the advantage to know about his risk exposure in advance. This can be most advantageous in order to consider and plan trading steps ahead.¹⁴

One of the highest valued aspects of options trading is the flexibility. Options offer numerous strategies for different purpose that can be implemented and combined.

Option strategies are designed to cover almost every possible market scenario with almost any price movement whether the price rises, falls or stagnates, which allots options a high flexibility. Extensions of simple option strategies as well as through the purchase and sale of calls and puts at different strikes, allows such constellations.

¹³ Appendix 1 – Financial Options [p. 1, paragraph 6]

Appendix 1.3 – Leverage Effect

K.R.Trester, 2004, *101 Option trading secrets*. Lake Tahoe: Institute for Option Research Inc. [p. 4]

<http://www.articlesbase.com/finance-articles/options-trading-benefits-of-leverage-119932.html> (23-02-11)

<http://www.learningmarkets.com/Options-What-We-Learned-Today/20080528114/options-leverage.html> (23-02-11)

¹⁴ Appendix 1.71. + 1.7.3 Buyer of a Call and a Put

K.R.Trester, 2004, *101 Option trading secrets*. Lake Tahoe: Institute for Option Research Inc. [p.3-4]

R.R.Warendorf, 2000, *All About Futures – The easy way to get started*. 2nd edition. New York: McGraw Hill [p. 218]

<http://www.optiontradebasics.com/options-trading-basics/advantages-trading-options/> (24-01-11)

<http://www.articlesnatch.com/Article/Advantages-And-Disadvantages-Of-Option-Trading-/977739> (16-03-11)

Mostly, these strategies are based on future expectations about the price of the underlying asset as well as its volatility, because these two define the categories for a bullish, bearish, volatility or neutral strategy.¹⁵

Moreover, option holders have the right, but are not obligated, to exercise an option. If the option reaps no profit, simply, allow the option to lapse worthless and pay the premium only. Different than futures (margin calls), the options holder does not underlie any commitments.¹⁶

4.1.2 Weaknesses

Besides the unlimited profit potential with a limited risk, options can also have an unlimited risk. Strategies with multiple positions are complicated to handle. Especially, writing an option or entering strategies that involve short positions confront higher risks and losses. Depending on whether the strike price for the strategy was bought or sold ITM or OTM increases or reduces significantly the risk of option trading. The bigger the difference between an OTM strike price and the spot price for a buyer of an option, the higher the leverage, but also the higher the risk that the option will not turn out to be profitable. On the other hand, an option bought deep ITM is costly; reduces the risk of a loss, but also the chances for high profits.¹⁷

Contrariwise, with the variety of options strategies comes a specific complexity and difficulty. Several factors need to be considered and observed such as the premium, the strike price, the market price and the bid and ask prices. Further, option strategies require a thoroughly study,

¹⁵ Appendix 1.15 – Complex Strategies

<http://www.zeromillion.com/financial-services/options-trading-advantages-and-disadvantages-by-tim-wreford.html> (24-01-11)

<http://www.articlesnatch.com/Article/Advantages-And-Disadvantages-Of-Option-Trading-/977739> (16-03-11)

<http://hubpages.com/hub/Advantages-and-Disadvantages-of-Option-Trading> (16-03-11)

<http://www.learnmoney.co.uk/options/pros-cons.html> (16-03-11)

<http://www.greekshares.com/options.php> (16-03-11)

¹⁶ Appendix 1 – Financial Options

<http://www.optiontradebasics.com/options-trading-basics/advantages-trading-options/> (24-01-11)

<http://www.orionfutures.com/opt.htm> (23-02-11)

<http://hubpages.com/hub/Advantages-and-Disadvantages-of-Option-Trading> (16-03-11)

¹⁷ Appendix 1.6 – option status

http://www.optiontradingpedia.com/options_leverage_calculation.htm (16-03-11)

<http://www.learningmarkets.com/Options-What-We-Learned-Today/20080528114/options-leverage.html> (16-03-11)

K.R.Trester, 2004, *101 Option trading secrets*. Lake Tahoe: Institute for Option Research Inc. [p.121]

<http://www.learnmoney.co.uk/options/pros-cons.html> (17-03-11)

and must be used with prudence, in order to avoid serious faults and be able to manage them perfectly.¹⁸

As mentioned above, an option with a strike price purchased ITM, maybe advantageous, but also costly. If the price of the underlying asset moves in the wrong direction, it will cost the money invested in the expensively purchased ITM option.

Also, in advanced option strategies it is difficult to maintain the overview. If one position collapses, it can cause the whole strategy to fail.

In total, all the strategies and features of an option transform it in a complex derivative instrument, which is partially complicated in its use and requires attention to details in order to prevent redundant surprises.¹⁹

In addition to that, if investors want to find out the fair value of an option, they need to know whether it is a European- or an American-style option. The Black-Scholes Model determines the fair value of a European-style option at its expiration date, but it has problems to determine the fair value before maturity such as of an American-style option. Also, it is very complicated and needs a lot of input that may not be given such as the volatility for which different calculation models exist. Of course, when working with such theoretical models, one does not want to miscalculate volatility since it has a tremendous influence on options. On the other hand, the volatility models are theoretical and do not describe precisely the volatility of an underlying asset. However, for the determination of the fair value of an American-style option the binomial model is required.²⁰

Despite the fact that options are highly leveraged and option premiums are low, transactions costs, the bid/ask spreads as well as broker fees can reduce profits entirely. The significant numbers of strike prices for calls and puts, which are divided in bid and ask prices as well, can create wide discrepancies. These disparities of bid and ask are reflected in higher transaction costs. On a percentage basis it can be considerably higher than buying the underlying asset directly. Hence, the right strike price determines the threshold between risk and return or maximizing profit and minimizing costs.²¹

¹⁸ Appendix 1.10 – Factors influencing the option price

¹⁹ Appendix 1.6 – option status, 1.15 – Complex Strategies (long condor...), 1.11 + 1.12

²⁰ Appendix 1.2 – Option types and basic positions, 1.11 – BS-model, 1.12 – Binomial model

²¹ Appendix 1.13.1 – Transaction costs, 1.7 – Basic positions, 1.15 – Complex hedging strategies

R.R.Warendorf, 2000, *All About Futures – The easy way to get started*. 2nd edition. New York: McGraw Hill [p.172]

<http://www.zeromillion.com/financial-services/options-trading-advantages-and-disadvantages-by-tim-wreford.html> (23-02-11)

For the buyer of an option, whether call or put option, the time value declines as the option approaches its expiration date and the option the option can expires worthless. The time factor of an option loses value as it comes close to maturity. At the expiration of the option the time value becomes zero. However, with every time that lapse away the chance that the price makes a favourable move diminish and hence, the chance of being profitable.²²

Moreover, for stock options the holder is not entitled to have voting rights during the life span of the option contract(s), neither possess a stock of the company nor benefit from dividend payments.²³

4.1.3 Opportunities

Although hedging can be seen as an advantage, it rather enables the opportunity to give up favourable price movements and abstain from profits in order to protect against unfavourable price movements.

Due to the numerous option strategies, an investor can protect his position against almost any market condition. Some strategies permit to protect both sides, whether the price rises or falls, while others are just to hedge the risk and reduce losses. Mostly, an opposite position will be taken to offset unintended exposures such as, a slump in price (for instance short put position), to prevent severe losses.²⁴

Nowadays, technical advances favour online trading. Transactions can be done very fast online and prices can be obtained on a real-time basis. This almost guarantees that options can be received to its ordered conditions. Further, every exchange has a different trading platform

<http://www.referenceforbusiness.com/small/Bo-Co/Capital-Structure.html> (23-02-11)

<http://www.thinktrade.net/options-advantages-and-disadvantages.php> (24-02-11)

http://www.Ioption.com/index.php/definitions-option-trading/bid_ask_spread_options/ (16-03-11)

²² Appendix 1.8 – Option valuation, 1.8.2 – time value, 1.10.1 – volatility, 1.10.2 – maturity

<http://www.optionsmentoring.com/education-advantages.cfm> (24-02-11)

http://www.trading-plan.com/options_time_decay.html (24-02-11)

²³ <http://investing.lifetips.com/cat/59571/types-of-stock-options/index.html> (16-03-11)

²⁴ <http://www.zeromillion.com/financial-services/options-trading-advantages-and-disadvantages-by-tim-wreford.html> (24-01-11)

<http://www.stock-options-made-easy.com/options-trading.html> (16-03-11)

<http://hubpages.com/hub/Advantages-and-Disadvantages-of-Option-Trading> (16-03-11)

Appendix 1.13 – Option Strategies, 1.13.2 – Hedging strategies, 1.14 – Simple hedging strategies, 1.7.4 short put

that offers advantages. Mostly, these are supported by tutorial videos and other information to facilitate an entry and make it as comfortable as possible.²⁵

With regards to options, there exist, besides vanilla options (standard options positions such as puts, calls, and regular styles such as American-style and European-style), exotic options. These options imply other characteristics. An Asian-option depends on the average price of the underlying asset and not on the price at maturity (for European option). Also, these customized options are more complex and are mostly traded via OTC. Thus, options know no limits and provide new perspectives of trading.²⁶

Another opportunity for options is the exchange on which the derivative can be traded. Investors can benefit from the exchange's liquidity, variety of products, the services and transaction fees that are offered. A high liquidity reduces bid/ask spreads, but enables the chances of the placed order can be matched. Moreover, different products provide a greater choice and low transaction fees can enhance the profit potential.²⁷

Equally important is the information available for option trading. Several resources such as books and the internet contain plenty of information about option trading. Comprehension can be extended to understand options better and prepare trading procedures.

Additionally, if the information and dates on exchanges are provided in a clear and assessable manner, required information can be found fast, which eases an entry and facilitates trading on the exchange. Also, it might create a trustful and comfortable environment.

In option trading, sometimes arbitrage opportunities occur, which allow to reap a risk-free profit through buying an underpriced asset on the market and sell at its market price at the same time. These opportunities can happen, if inequalities in prices exist, which can be caused by mispricing.²⁸

At last, influencing events, as further described in threats, can have a positive impact on option trading as well and can incidentally cause a favourable movement of the spot price.

²⁵ <http://www.optiontradingportal.com/online-trading-opportunities-explored.html> (16-03-11)

K.R.Trester, 2004, *101 Option trading secrets*. Lake Tahoe: Institute for Option Research Inc. [p.213-214]

²⁶ <http://www.slate.com/id/2260463/> (16-03-11)

Appendix 1.4 – OTC

²⁷ Appendix 2.4 – Bid/ask prices, 1.13.1 – Transaction costs

²⁸ Appendix 1.9 – Arbitrage

http://www.optiontradingpedia.com/options_arbitrage.htm (19-03-11)

4.1.4 Threats

Certain influencing events such as political (P), economical (E), social (S) and technological (T) factors can have a huge impact on option trading. These macro environmental factors describe a PEST-Analysis.

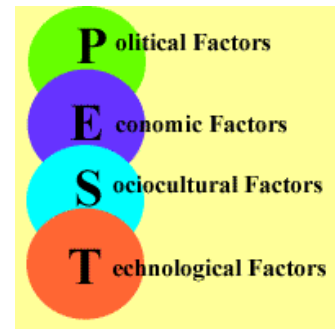

The political factors that can influence the price of the underlying asset or the exchange can be, for example, new governmental regulations and laws, elections (new CEO of a company f.e.), tax policies or trade restrictions.

Economic factors affect the purchasing power of investors or traders. If the economy growth is low, interest rates rise or inflation increases, for instance, and traders may be less willing to invest on the market, which reduces the liquidity and increases bid/ask spreads.

For sociocultural factors, aspects such as the personal wealth as well as trends might preclude to trade at all or motivate to trade on another exchange.

Technological innovation and developments of exchanges, as earlier mentioned, can influence option trading as well. Obsolete trading platforms as well as high fees charged for services, can prevent or reduce trading on the market.

The pest analysis describes merely four factors that influence and can pose a threat to option trading. However, there are more factors, such as environmental (weather), legal (laws), terror attacks and more (further described in chapter 5.2), which extend the PEST-analysis to a PESTEL-model.²⁹

Naturally, options are offered at a vast array of strike prices to cover the demand of investors, planning their option strategies. However, the liquidity can suffer under the contingent of strike prices, which makes trading difficult. The strike price can be a crucial threshold making it difficult to finish with a profit as the weakness leverage pointed out.

It exists the likelihood that the preferred strategy or position cannot be closed at the desired strike prices or at the appointed time due to supply shortages (not enough buyers or sellers). Furthermore, the numerous option strategies can become unfeasible and less liquid if not enough options at the desired strike prices are available to close the positions. Also, if the

²⁹ Chapter 5.2 – Influencing events

<http://www.ppm.net/wp-content/uploads/2009/05/pest.jpg> (19-03-11)

http://www.oup.com/uk/orc/bin/9780199296378/01student/additional/page_12.htm (10-04-11)

trading volume is low, bid ask spreads increase, which cause commission fees to climb up. In the end, these fees might eat up the entire profit.³⁰

The volatility can become a pitfall. Volatility is based on subjectivity, because all forms of volatility demand some sort of prediction. Thus, miscalculations of volatility can lead to misinterpretations of the models to determine the fair value, which in return implicate a negative surprise. Moreover, the natural impacts of events are capable to throw plans into disarray, whether the depiction of the volatility was very accurate or not.³¹

Exchange's rules and regulations can put boundless trading to a limit. They can have high requirements, such as competency, solvency, liquidity and other factors, to become a member and maintain an own account. If one cannot fulfil the requirements, but still wants to trade, a member of the exchange or a broker needs to maintain the account on behalf. Nonetheless, members and brokers charge fees for maintaining the account. Also, the number of contracts that can be traded on an exchange might be limited. Thus, certain regulations can constraint trading and reduce profits.³²

³⁰ <http://www.zeromillion.com/financial-services/options-trading-advantages-and-disadvantages-by-tim-wreford.html> (23-02-11)

L.-Waldock, 2005, *The Complete Guide to Futures Trading*. New Jersey: John Wiley & Sons Inc. [p.10, paragraph 2] + [p.66-67]

<http://www.thinktrade.net/options-advantages-and-disadvantages.php> (24-02-11)

³¹ <http://www.hoadley.net/options/bs.htm> (19-03-11)

³² I. Uszczapowski, 2008, *Optionen und Futures verstehen – Grundlagen und neue Entwicklungen*. 6th edition. München: Deutscher Taschenbuch Verlag [p.217]

4.2 Futures

Futures possess like options similar as well as different characteristics in terms of strengths, weaknesses, opportunities and threats.

	Positive	Negative
Internal Factors	Strengths S <ul style="list-style-type: none"> • High leverage • Low commissions • Liquidity • Easy appliance • One account • Transparency 	Weaknesses W <ul style="list-style-type: none"> • Leverage • Margin Calls • Less flexible • Commitment • Different sizes & price of products
External Factors	Opportunities O <ul style="list-style-type: none"> • Hedging • Orders • Online trading • Exchange market's volumes, products • Information & Research • Arbitrage 	Threats T <ul style="list-style-type: none"> • Influencing events • Leverage • Exchange 's rules and regulations • Faults • Overtrading

Figure 5 – Swot-Analysis Futures

4.2.1 Strengths

Futures possess a high leverage as well. Suppose an investor takes a long position and buys a futures contract on an underlying asset. For a future position the investor only needs to invest a partial amount of the nominal value, the initial margin, which can be between 2 and 15 percent (5 and 20, varies slightly) of the nominal value. However, if the market price develops

in favour of the investor, he can reap huge profits, due to the leverage effect. Also, he will regain the margin paid on the futures account.³³

With a view to futures, the transaction costs for buying or selling a futures contract are very small, which generally has to do with the higher liquidity of futures. Higher liquidity reduces bid/ask spreads, which allows lower transaction fees. Further, in comparison with options, the commission fees are said to be smaller and charged at the end after the position has finished.³⁴

Futures do not provide a large mix of strategies to implement, but are simple and uncomplicated to use. They do not need a thorough understanding of its content or details. Basically, depending on whether the price is going to rise or fall, one buys or sells futures. In comparison with options, several factors do not need to be taken in account such as premium, volatility, time until maturity and strike price, because they do not appear or are irrelevant for futures.³⁵

The variety of speculating can be spread over commodities such as gold, grain, soybeans etc to indices and currencies. Thus, multiple contracts can be entered trading different instruments or commodities. Advantageously, one future account is necessary to maintain all margins. The initial margin and maintenance margin will adapt according to the contracts held.³⁴³⁵

³³ <http://value12.com/futures/vorteile/index.html> (04-01-11)

<http://www.ameinfo.com/87105.html> (04-01-11)

I. Uszczapowski, 2008, *Optionen und Futures verstehen – Grundlagen und neue Entwicklungen*. 6th edition. München: Deutscher Taschenbuch Verlag [p. 221]

L.-Waldock, 2005, *The Complete Guide to Futures Trading*. New Jersey: John Wiley & Sons Inc. [p.7+8]

<http://www.articlesbase.com/finance-articles/3-great-advantages-of-futures-trading-579618.html> (24-02-11)

Appendix 2.2 – Characteristics of Futures, 2.4 Bid/ask spreads, 2.5.2 – Transaction costs,

<http://www.ilikeinvesting.com/general-investment-articles/a-forward-contract.php> (03-03-11)

³⁴<http://www.zeromillion.com/financial-services/options-trading-advantages-and-disadvantages-by-tim-wreford.html> (24-02-11)

R.R.Warendorf, 2000, *All About Futures – The easy way to get started*. 2nd edition. New York: McGraw Hill [p.6, 1.6-7]

<http://value12.com/futures/vorteile/index.html> (04-01-11)

<http://www.articlesbase.com/finance-articles/3-great-advantages-of-futures-trading-579618.html> (24-02-11)

<http://www.tipsformoms.net/advantages-of-futures-trading/> (16-03-11)

³⁵L.-Waldock, 2005, *The Complete Guide to Futures Trading*. New Jersey: John Wiley & Sons Inc. [p.8 – Futures are straight]

<http://www.ilikeinvesting.com/general-investment-articles/a-forward-contract.php> (23-02-11)

<http://value12.com/futures/vorteile/index.html> (04-01-11)

Appendix 2.2 – Characteristics of Futures, 2.8 – Strategies, 2.9

Most of the futures that are traded globally reflect actual prices of the underlying asset from which they derive. Trading prices on commodities adapt according to the other investors that buy or sell the respective commodity and are transmitted to all exchanges and markets around the world. As a result, futures become very transparent. Everyone can keep track of the prices listed on the exchanges and prepare trading steps. Different than options, a fair value is not needed to be calculated, since the markets almost perfectly reflect actual prices.³⁶

4.2.2 Weaknesses

Oppositely to a high leverage, margin calls can claim a high tribute. Futures can demand high margin requirements to maintain the account and trading position, if the price moves in an unfavourable direction. Failing to discharge the margin requirement can lead to a liquidation of the position and everything invested up to that point. Futures rely on the underlying asset and the risk cannot be assessed before. Consequently, the loss (and the profit) can be unlimited.³⁷

Different than in option trading, futures commit the investor to buy or sell the underlying asset. If the future fails to be profitable, then there is no possibility of just letting the contract expire worthless (like an option). According to that, whether the price rises or falls, it is inevitable to avoid the loss unless the investor is able to offset it by another position before the contract expires.³⁸

Futures provide two alternatives, whether to speculate on a rise or a fall in price, which can be undertaken by buying or selling a future. Unlike options, futures do not offer various strategies, to protect or benefit from different market conditions.³⁹

³⁶ <http://futures.militarygrunt.com/how-futures-contracts-give-you-powerful-trading-advantages/> (20-03-11)

³⁷ Appendix 2.2.6 – Margins

<http://www.atlantik.cz/en/our-offering/products/futures-contracts/advantages-and-disadvantages> (23-02-11)

L.-Waldock, 2005, *The Complete Guide to Futures Trading*. New Jersey: John Wiley & Sons Inc. [p.9]

J.C. Hull, 2008, *Fundamentals of Futures and Option Markets*. 6th edition. New Jersey: Prentice Hall [p. 15]

³⁸ Appendix 2.1, 2.2

L.-Waldock, 2005, *The Complete Guide to Futures Trading*. New Jersey: John Wiley & Sons Inc. [p.3+6+8]

³⁹ L.-Waldock, 2005, *The Complete Guide to Futures Trading*. New Jersey: John Wiley & Sons Inc. [p.8]

When trading multiples futures contracts of different underlying assets, it can create complications in handling the margin account, because products such as commodities have different sizes (for example, bushels, ounces or barrels) and prices.⁴⁰

4.2.3 Opportunities

A few aspects that have been mentioned as opportunities for options apply for futures as well. These include hedging, online trading, the trading volume and product range of exchange's, arbitrage opportunities and information & research.

In addition to that orders can be implemented in futures trading. These orders facilitate the entry or exit of positions, for example, to close a position as soon as a certain priced has been reached. Furthermore, they help to limit and reduce losses (risk). Even though, orders can be placed on options as well, they are rather used in futures trading, because of fast changing prices and the daily trading approach of futures.⁴¹

4.2.4 Threats

Together with options, futures have partially the same external factors that can have an influence. For futures as well as for options, the influencing events, the leverage as a double edged sword and the rules and regulations of exchanges apply.

One common regulation for exchanges is that they have a price limit for futures trading. As a form of security, exchanges set up sometimes daily price limits to protect or reduce the risk of not committing the future contract. Further, when the price of the respective underlying asset is fluctuating too much, the limit price can be reached very quickly and the trading ends unintended for the investor.⁴²

⁴⁰ http://www.ehow.com/list_6564514_disadvantages-futures-trading.html (20-03-11)

⁴¹ L.-Waldock, 2005, *The Complete Guide to Futures Trading*. New Jersey: John Wiley & Sons Inc. [p.8]

<http://value12.com/futures/vorteile/index.html> (04-01-11)

<http://www.tipsformoms.net/advantages-of-futures-trading/> (16-03-11)

<http://www.atlantik.cz/en/our-offering/products/futures-contracts/advantages-and-disadvantages> (16-03-11)

⁴² I. Uszczapowski, 2008, *Optionen und Futures verstehen – Grundlagen und neue Entwicklungen*. 6th edition. München: Deutscher Taschenbuch Verlag [p.221]

<http://www.nfa.futures.org/nfa-investor-information/publication-library/opportunity-and-risk-entire.pdf> [p.21]

Contrary to orders, they imply a threat as well. As soon as one places an order via an online brokerage the order is set and there is no going back. If the order was placed wrong, the financial market makes no exceptions and one needs to bear the consequences of the error made. Further, it can happen that the placed order may not be executed to the most favourable price. Also, when placing orders via an online brokerage, be aware that some brokerages do accept some specific orders. Moreover, some neglect the addition or combination of several orders. These are restrictions and policies reserved for every derivative exchange or brokerage. Inform about such policies ahead to prevent misunderstandings and surprises.⁴³

Futures trading involve low commission fees and tight spreads for buying and selling futures, attracting to trade even more contracts. However, such further trading can end in a vicious cycle, pushing the margin account into a big loss or even liquidation of positions.⁴⁴

⁴³ D.Kline, 2000, *Fundamentals of the futures market*. New York: McGraw Hill [p.46]

<http://www.nfa.futures.org/nfa-investor-information/publication-library/opportunity-and-risk-entire.pdf>

⁴⁴ <http://ezinearticles.com/?Online-Futures-Trading---Advantages-and-Disadvantages&id=57886> (23-02-11)

5. Comprehending the market

5.1 Background information

The financial markets react and operate very mutual. They live from the hopes to gain a high profit as well from those that fear to invest. Some push the market and make abrasively and audacious investment while other try to speculate cautious and behavioural, moving the investment trend in another direction. If a market makes a complete turn, clever investors will back out and others will stay, still hoping to leave with a profit, but ultimately terminate with a loss.

Especially, before starting and to trade options or futures, one should be familiar with the underlying asset that is going to be traded (i.e. prices, volumes, volatilities...). Thus, as for any other subject, background information should be studied in advance in order to apply the right initiative or strategy.

Also, during trading it is essential to retain up-to-date with actual information and data about the underlying assets that is traded, such as by newspapers, radio, television and other resources. This means not necessarily to look out only for prices, volumes, and other data of the underlying asset, but also to look for announcement of managerial levels of the respective company as well as possible influencing events. If a trend or a change of course can be predicted, then countervailing measures need to be initiated in order to prevent or mitigate contingent losses. Of course, such opportunities also help to encourage, to reap profits.

In some cases reading newspapers, watching television and searching the internet might not be sufficient to provide an adequate basis. It is necessary to allocate other resources to find additional data and information that might not be covered by newspapers and the internet.

Numerous traders have access to either one or both of the biggest financial data providers in the world, Reuters and Bloomberg. Two platforms, constructed mainly to serve one purpose, to provide traders, investors, brokers, banks and others an environment, which primarily embraces rich information about financial instruments and the financial markets. Equipped with special search tools, different chart visualisations and other applications, these data platforms aggregate and facilitate information flows. However, both have a disadvantage. The

gathering of all the information has its costs and not everybody in the world is granted an access.⁴⁵

5.2 Influencing events

Nowadays, economical events (such as gross domestic product, unemployment,...), political events (elections,...), natural events (weather, earthquakes tsunamis,...), pandemic events, war, insider news (rumours about takeover,...) and others have an unpredictable impact on the financial markets. A single or a small incident can have already a positive or negative influence, which in return mostly affects the prices of derivatives. The shocking tragedy of “9/11” was an example of how exchange markets can collapse. However, markets quickly recover from such events or crisis.⁴⁶

Some events, such as the blowout of BP’s “Deepwater Horizon” in the second quarter of 2010, were unpredictable. BP had to bear the consequences, which reflected the dramatic fall of the common stock prices. Noticeably, a good portion of BP’s price recovered rapidly within one month after its low point.



Source: <http://www.treehugger.com/burning-oil-rig-explosion-fire-photo11.jpg> (20-01-11)

⁴⁵ L.-Waldock, 2005, *The Complete Guide to Futures Trading*. New Jersey: John Wiley & Sons Inc. [p.97]

K.R.Trester, 2004, *101 Option trading secrets*. Lake Tahoe: Institute for Option Research Inc [p.7+16]

P.M.Johnson, 1999, *Derivatives, A manager’s guide to the world’s most powerful financial instrument*. New York: McGraw Hill [p.110]

⁴⁶ P.M.Johnson, 1999, *Derivatives, A manager’s guide to the world’s most powerful financial instrument*. New York: McGraw Hill [p.42, last parag.]

M.Williams, A.Hoffman, 2000, *Fundamentals of the Options market*. New York: McGraw Hill [p.56,2.para]

R.R.Warendorf, 2000, *All About Futures – The easy way to get started*. 2nd edition. New York: McGraw Hill [p.73]

http://www2.stetson.edu/fsr/abstracts/vol_16_num2_p89.PDF (20-01-11) [p.3]

<http://www.slate.com/id/2122187/> (20-01-11)

BP p.l.c. Common Stock (NYSE: BP)



Source: <http://finance.yahoo.com/q?s=BP> (20-01-11)

Another recent example demonstrates the impact of such events. On the 17th of January 2011 dropped the stock price of Apple Incorporated significantly after the announcement about a “medical leave” from Apple boss, Mr. Steve Jobs.⁴⁷ Steve Jobs third “medical leave” gave reason to speculate about his health condition and the future of the Apple Corporation due to his leader qualities and technical visions. The graph below shows how the stock dropped by 16 basis points (0.16%). Nonetheless, the US stock markets were closed when the news about Mr. Jobs medical leave were announced.⁴⁸ Thus, it explains the large gap in the curve. Though, when the markets opened again, the stock price started at a low of approximately \$ 332 compared to its previous market price of \$ 348. This is equal to a drop in value by 5%.

⁴⁷ <http://www.bbc.co.uk/news/technology-12205173> (19-01-11)

http://www.thirdage.com/news/stock-prices-apple-stock-sink-jobs-takes-medical-leave_1-18-2011 (19-01-11)

<http://www.reuters.com/article/idUSTRE70G2Y320110117> (20-01-11)

⁴⁸ <http://www.guardian.co.uk/technology/2011/jan/17/steve-jobs-apple> (20-01-11)

Apple Inc. (NasdaqGS: AAPL)



Source: <http://finance.yahoo.com/q?s=AAPL> (20-01-11)

These examples have proved how sensible financial markets react on such incidents and events in the short or in the long term. Even little announcements or information are from a certain relevance and importance to traders or owners that possess stock of the related company. However, market prices recover rapidly. As for the Apple case, such announcement instantly created an opportunity to purchase stocks, or call options, for example, at a low price before it recovers again.

Thus, sometimes it is possible to identify such happenings by carefully studying information and news. In some situations it may allow traders to speculate ahead and gain a profitable advantage above others.

At last, volatility describes the fluctuation of securities on the financial markets. Even though, the fluctuations are influenced by normal trade activities such as demand and supply, the announcement of news composes an important factor as well. Some news will be announced publicly and others not. Furthermore, unemployment rates, economic activities, declaring changes in prime rates; those affect fluctuations of securities on the financial markets. Strategic behaviour of government and financial institutions try to prevent enormous fluctuations through anticipations of publications. Nonetheless, natural, environmental disasters or terroristic events cannot be prevented and bring along an unforeseeable influence on volatility. On the whole, predicting volatility or market prices is very difficult.

6. Eurex

Eurex, short for European Derivative Exchange, belongs to one of the few Pan-European, but also most successful derivative markets in the world. In 1998 the Eurex was established through a merger of the German derivative exchange (DTB) and the Swiss options and financial future exchange (SOFFEX) and is located in Zurich. Today the Eurex is equally owned by Deutsche Börse AG as well as the SIX Swiss Exchange AG to 50 percent. The merger could reduce trading costs as well as reduces risk due to cross-border clearings. Further, the market product range could be extended, offering various forms of derivatives such as equity, credit, interest rate and inflation, for instance, which are mostly denominated in the currency Euro.⁴⁹



6.1 Products

Eurex provides a vast array of derivative products, which includes various different options and futures contract possibilities of which most came already with the consolidation:

Products

Trading on Eurex is simply a must to cover your exposure to the European financial markets. Our diversified product suite covers various asset classes and includes some of the world's most heavily traded futures and options contracts. The product range comprises:

- Interest Rate Derivatives (f.e. Euro-Bund Futures, Euro-Bobl Futures)
- Equity Derivatives (Equity Options and Single Stock Futures based on European, Brazilian and US underlyings)
- Equity Index Derivatives (f.e. EURO STOXX 50® Index Futures, DAX® Futures, SMI® Futures)
- Equity Index Dividend Derivatives
- Volatility Index Derivatives
- Exchange Traded Funds Derivatives
- Credit Derivatives (iTraxx® Europe 5-year Index Series, iTraxx® Europe HiVol 5-year Index Series, iTraxx® Europe Crossover 5-year Index Series)
- Inflation Derivatives
- Commodity Derivatives (Agriculture Derivatives, Gold and Silver Derivatives, Power and CO₂ Derivatives in cooperation with EEX)
- Weather Derivatives
- Property Derivatives

Source: http://www.eurexchange.com/trading/products_en.html (05-03-11)

⁴⁹ http://www.eurexchange.com/about/corporate/milestones_1996_en.html (21-01-11)

http://www.eurexchange.com/about/corporate_structure_en.html (21-01-11)

http://www.eurexchange.com/about/press/press_262_en.html (21-01-11)

B. Rudolph, K. Schäfer, 2005, *Derivative Finanzmarktinstrumente*. Heidelberg: Springer-Verlag GmbH [p.64]

Most of the derivatives groups or categories as listed above show examples of their typical or most traded products. The first one, for example, interest rate derivatives shows Euro-Bund Futures and Euro-Bobl Futures, which are merely two of four futures on fixed income derivatives to reduce interest rate risk.

The equity derivatives enable to place individual equity options and single stock futures on companies spread across a great list of indices:

- | | | |
|----------------------------------|--------------------------------|------------------------------------|
| → EURO STOXX 50® | → STOXX Europe 50® | → STOXX® Europe 600 |
| → STOXX® Europe Large 200 | → STOXX® Europe Mid 200 | → STOXX® Europe Small 200 |
| → DJ Global Titans 50® | → FTSE® 100 | → DAX® |
| → MDAX® | → SDAX® | → TecDAX® |
| → SMI® | → SMIM® | → AEX Index® |
| → ATX | → CAC 40® | → RDXxt® USD - RDX Extended |

Through this wide spectrum of indices, the trader can select from a list that seems to be endless. Further, these companies listed on the different indices are distributed via 12 countries (as for options) and 19 countries (as for single stock futures). Also, futures can be traded on the S&P 500 as well.⁵⁰

Similarly, with equity index derivatives, traders can hedge their exposure by country, region or sector (index, country, region for equity derivatives) with single futures or options contracts on index movements. Also, equity index derivatives include the ability for customized trading of standard Eurex products off-side the exchange. This service is provided by Eurex through their wholesale trading facilities.⁵¹

Equity Index Derivatives

- **DAX®**
- **SMI®**
- **SLI Swiss Leader Index®**
- **OMXH25**
- **Dow Jones**
- **STOXX® Indexes**
- **MSCI Index**
- **SENSEX**
- **KOSPI**

In addition to that, traders can obtain single stock dividend futures or equity index dividends futures (only options on Euro Stoxx 50 index dividend) to benefit from those single shares or indices (cumulative through the individual dividend payments) that constitute dividend payments.⁵²

⁵⁰ http://www.eurexchange.com/trading/products/EQU/OPT/index/ESX50/products_en.html (06-03-11)

⁵¹ http://www.eurexchange.com/trading/products/IDX_en.html

See Chapter 6.3.1 –Order books & Wholesale trading

⁵² http://www.eurexchange.com/trading/products/DID_en.html (06-03-11)

Furthermore, volatility index derivatives can be bought either with futures or with options. The volatility index (vstox) is based on the Euro Stoxx 50, and helps to hedge downside risks or especially portfolio exposures, which include securities of the Euro Stoxx 50.⁵³

Another opportunity for trading, offer the Exchange Traded Funds, short ETF's. Typically, they are presented via option contracts, but can also be traded as futures. Since, ETF's certify the right to possess, as in an investment fund, a fraction of a fund asset and can be traded as shares. The shares, in respect for the ETF's, track its original index, trying to replicate the index, which gives ETF's sometimes the name tracker. Here, the implementation of options gives the ETF's greater flexibility through the leverage effect, and manage exposures of the own portfolio. Eurex offers five different ETF's that can be traded as options and partially as futures.⁵⁴

Moreover, Eurex introduced on the 27th of March in 2007 the world's first tradable credit derivatives, whose values are derived from selected entities (selected by the International Index Company Ltd.) that incurred debt. A speciality of these credit futures is the possibility to hedge against corporal defaults and the failure to pay, whereas all of the credit derivatives Eurex offers are unfunded credit derivatives. Thus, both parties that enter a credit derivative contract are responsible for their payments without obligations.⁵⁵

Nonetheless, such a diverse product range did not stop Eurex to amplify their offering range further. Especially, extraordinary derivatives such as inflation, CO₂, hurricane and real estate derivatives were added to their product range, and set new incentives.

By the end of December 2007, Eurex proposed, besides their gold, silver and agriculture commodity futures, a new commodity derivative. CO₂ futures were proposed in cooperation with the European Energy Exchange (EEX). Incentives for the issue of such a derivative gave the increasing CO₂ emissions as well as the trading demand. However, special admission is required to be able to trade EEX-CO₂ futures.⁵⁶

⁵³ http://www.eurexchange.com/trading/products/VOL_en.html (06-03-11)

⁵⁴ http://www.eurexchange.com/trading/products/ETF_en.html (06-03-11)
<http://www.finanztip.de/recht/bank/exchange-traded-funds-grundlagen.htm> (06-03-11)

<http://www.nasdaq.com/investing/etfs/what-are-ETFs.aspx> (09-03-11)
⁵⁵ http://www.eurexchange.com/trading/products/CRD_en.html (09-03-11)

<http://www.mayerbrown.com/london/article.asp?id=4234&nid=1575> (09-03-11)

⁵⁶ <http://www.euractiv.com/en/climate-change/european-co2-emissions-2007/article-171327> (06-03-11)
http://www.eurexchange.com/trading/products/COM_en.html (06-03-11)

Further diversifications represent the future contracts on the harmonised index of consumer prices of the Eurozone, which were introduced by the beginning of 2008. This unique inflation derivative enables participants to hedge their short-term inflation risks as well as speculate on the inflation in the Eurozone.⁵⁷

Additionally, on the June 29th in 2009 Eurex amplified their product range by weather derivatives. These offer future contracts on hurricanes in the US, in Florida and the in Gulf, which trigger at certain levels of estimated insurance losses.⁵⁸

Also in 2009, property derivatives (futures) had been introduced at Eurex as the first ones in Europe.

Besides all these derivatives, Eurex enables participants the opportunity to trade the most liquid U.S. options that are listed on the International Securities Exchange (ISE). Members of Eurex do not need to be a member or registered at the ISE to trade these options.⁵⁹

At last, it can be said that Eurex offers traders a wide product range of liquid, popular and unique derivatives, mostly constructed of futures. These derivatives seem to be continuously extended to place new incentives, attract further investors and enhance liquidity.⁶⁰

6.2 Liquidity of Contracts (Trading volume)

In the last five years Eurex could record a strong increase in trading volume. The total volume increased by 24.2 percent from 2006 until 2010 with an average growth of seven percent per year, although the trading amount dropped significantly in 2009.⁶¹

Year	Total Trading Volume		
	Eurex	ISE	Eurex + ISE
2006	1,526,751,902	591,961,518	2,118,713,420
2007	1,899,861,926	804,359,093	2,704,221,019
2008	2,165,043,183	1,007,661,590	3,172,704,773
2009	1,687,497,486	960,247,551	2,647,745,037
2010	1,897,403,285	745,175,111	2,642,578,396

Table 3 – Eurex total trading volume 2006 – 2010⁶²

⁵⁷ http://www.eurexchange.com/trading/products/IND_en.html (09-03-11)

⁵⁸ http://www.eurexchange.com/trading/products/WED_en.html (06-03-11)

⁵⁹ http://www.eurexchange.com/trading/products/eurex_ise_en.html (31-03-11)

⁶⁰ http://www.eurexchange.com/trading/products/PRD_en.html (06-03-11)

⁶¹ Appendix Chapter 3.1 – Eurex growth values

One third of Eurex trading volume comes from the ISE, which is an affiliate company of the Eurex, but it is incorporated for the holistic view of Eurex, except for global comparisons. Nevertheless, for further references and explanations the emphasis will remain solely on Eurex.⁶³

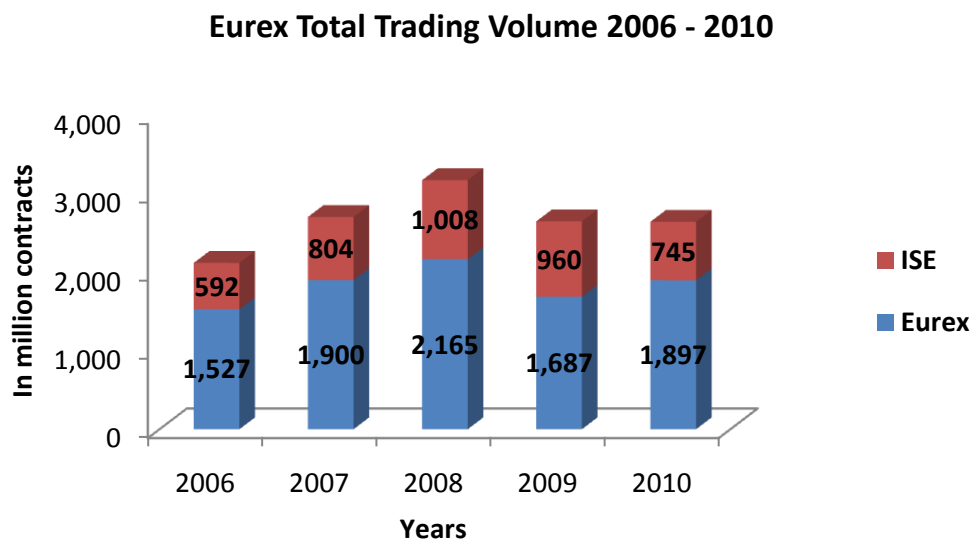

Figure 6 – Eurex trading volume 2006-2010 stacked bar chart

The financial crisis in 2008 left some conspicuous marks. As the stacked bar charts show, trading volume (Eurex) plunged by 400 million contracts in 2009 and yet, has not recovered in 2010. However, this depends on the point of view. Eurex alone could register an increase of approximately 210 million cleared contracts in 2010, while ISE lost approximately 215 million contracts compared to 2009. In total, the amount of cleared contracts decreased further in 2010 by about five million contracts as the numbers in the table above illustrate.

In detail, most of the contracts traded at Eurex consist of equity, equity index and interest rate derivatives. Even though the product range is wide and diversified, each of the other products constitute less than one percent for the last couple of years. However, one has to say that some of the product groups were recently introduced. Statistics show that these three derivative groups formed 97-99 percent of the contracts traded at Eurex.⁶⁴

⁶² http://www.eurexchange.com/download/documents/statistic1102_en.pdf (08-03-11)

⁶³ http://www.eurexchange.com/about/corporate/ise_en.html (08-03-11)

⁶⁴ Appendix 3.2 – Eurex trading volume, 3.3 – Eurex trading volume 2010 by product group

In addition to that became the OTC trading at Eurex very popular. Especially in the years 2006 until 2008, OTC trading increased almost twice as much as orders placed in the central order book. Both, whether standardized or customized trading, had to sustain a regression in 2009. However, standardized trading recovered three times as much as OTC trading in 2010.⁶⁵

Furthermore, in view of the distribution of options and futures, futures considerably exceed options. In the years 2006, 2007 and 2009, 20 percent more futures than options were traded. In 2008 and 2010 this difference diminished to 10 percent. Nonetheless, there are still more future contracts traded than options, which holds for the regular (central order book) and OTC trading as well.⁶⁶

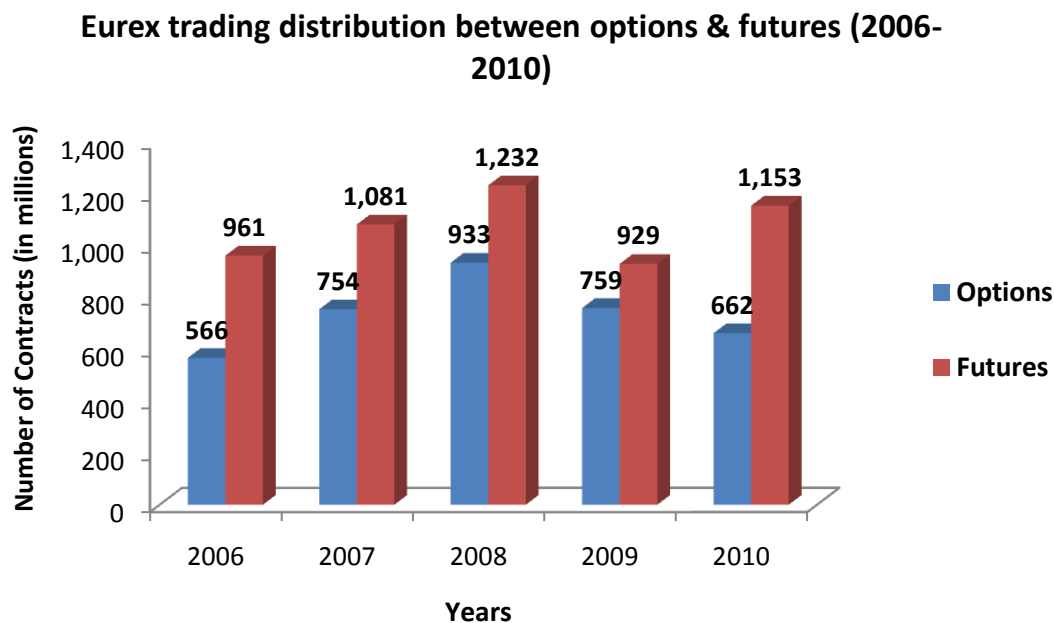

Figure 7 – Eurex trading distribution by options and futures

6.3 Trading Costs & Fees

Eurex charges different fees and prices for trading options and futures via their exchange. Basically, the transaction fees cover the costs for the employees and facilities to operate

⁶⁵ See Appendix 3.5 – Eurex trading volume distribution

⁶⁶ See Appendix 3.5 – Eurex trading volume distribution

Eurex. Along with these principles, the fees include also the admission and participation of trading options and futures at Eurex.⁶⁷

In the first place, the fees are assigned to every product and product group, which vary among themselves. Furthermore, the trading fees stated for every product already contain clearing costs (commission fees for the clearing house). Hereby, it is important to consider that broker fees are not included and may need to be added separately.⁶⁸

Trading Fees & Pricing

Contract	Currency	Order Book		Wholesale		Threshold A-Accounts (Number of contracts)	Threshold P-Accounts (Number of contracts)
		Standard Fee	Reduced Fee	Standard Fee	Reduced Fee		
Equity Derivatives/Single Stock Futures							
Futures on European Equities (EUR)	EUR	0.13	0.00	0.20	0.00	1.000	1.000
Futures on Swiss Equities	CHF	0.20	0.00	0.30	0.00	1.000	1.000
Futures on Brazilian, Canadian, Russian and U.S. Equities	USD	0.20	0.00	0.30	0.00	1.000	1.000
Futures on British Equities	GBP	0.10	0.00	0.15	0.00	1.000	1.000

Source: extract of table http://www.eurexchange.com/trading/fees_en.html (08-03-11)

The table above presents an extract of the original table shown on the Eurex website. All derivative products that Eurex offers are listed in that table with the respective fees.

The first column represents the contract type. Each of these contracts (options or futures) are categorised under product groups such as equity derivatives, commodity derivatives or weather derivatives, and can be recognised by bold letters.

The second column shows the currency. Although, Eurex consists of the DTB and SOFFEX, not all futures or options contracts are traded in the currencies EUR or CHF.

The next two columns, order book and wholesale, are characterized by standardized or OTC trading at Eurex, whereas standardized trading are registered in the order book and customized trading in the wholesale.

Each of them, if applicable, is a standard and a reduced fee assigned. More information on the order book and the wholesale trading is explained in the next sub-chapter.

⁶⁷ http://www.eurexchange.com/download/documents/regulations/fee_germany/fee_germany_en.pdf (09-03-11)

http://www.eurexclearing.com/download/documents/regulations/price_list/price_list_clearing_en.pdf (09-03-11)

⁶⁸ http://www.eurexchange.com/trading/fees_en.html (08-03-11)

The last two columns, threshold a- and p-accounts, describe two different types of account. They distinguish themselves by the type of participant. Generally, there are four forms of accounts:

- Position Accounts
- Premium Accounts
- Fee Accounts
- Cash/Securities Accounts⁶⁹

However, only the fee account is of importance, when looking at the trading fees.

In addition, these four categories of accounts can be owned by each of the following participants:

- Principal (P)
- Agent (A)
- Market Maker (M)
- Designated-give up (G)⁷⁰

Also, hereby only the first three types are relevant to explain the trading fees. Principal accounts are owned and maintained by Eurex clearing members. These members are responsible for their own account. Moreover, agent accounts are owned and maintained by Eurex clearing members as well, but on behalf of none-clearing members and customers (third party).

M accounts are left out, because the transaction fee for all market makers is fixed by the “standard fee”, regardless of the trading volume.⁷¹

Apparently, the threshold a- and p-accounts state the minimum number of contracts that determines whether the standard or the reduced fee applies.

⁶⁹ http://www.eurexchange.com/clearing/model/accounts_en.html (09-03-11)

⁷⁰ http://www.eurexchange.com/documents/glossary_en.html?id=Account+Type (09-03-11)

⁷¹ http://www.eurexchange.com/download/documents/regulations/price_list/price_list_clearing_en.pdf [p. 6] (09-03-11)

http://www.eurexchange.com/download/documents/regulations/clearing_conditions/clearing_conditions_en.pdf [p.49, chapter 4.2] (09-03-11)

http://www.eurexchange.com/clearing/model/accounts_en.html (09-03-11)

Standard Fee per contract (contract volume ≤ threshold)	Reduced Fee per contract (contract volume > threshold)	Threshold A-Accounts (number of contracts)	Threshold P-Accounts (number of contracts)
€ 0.15	€ 0.08	1,000	1,000

Table 4 – Example standard & reduced fee at Eurex⁷²

According to Eurex regulations, the standard fee will be triggered as long as the number of contracts is smaller or equal to the number of contracts stated in the threshold a-account within one calendar month. Thus, as an example, if the number of contracts exceeds the specified number of 1,000 contracts, then the reduced fee will become effective (€ 0.08).⁷³

For some product groups, the fees are not dependent on the number of contracts, because they are not applicable. Especially, for products that involve indices, because they already represent an aggregated and weighted price from which the investor benefits. Since no number of contracts applies, the reduced fee is no longer required.⁷⁴

In addition to that it was said that all clearing costs are included. Though, a few exceptions still exist. Mainly, CO2 and power derivatives are charged an extra fee by the Eurex Clearing AG (ECGA) for transactions via the EEX. The contracts provided with two stars (**) receive an additional clearing fee of EUR 1.00 while the ones with three stars (***) get an extra fee of EUR 0.005. In addition to that, the fee for derivatives marked by one star (*) is calculated by a percentage of the contract value, the premium.⁷⁵

⁷²http://www.eurexchange.com/download/documents/regulations/price_list/price_list_clearing_en.pdf [p. 6] (09-03-11)

⁷³http://www.eurexchange.com/download/documents/regulations/price_list/price_list_clearing_en.pdf [p.17] (09-03-11)

⁷⁴<http://www.market-harmonics.com/option2.htm>

⁷⁵http://www.eurexchange.com/trading/fees_en.html (08-03-11)

http://www.eurexchange.com/download/documents/regulations/price_list/price_list_clearing_en.pdf (09-03-11) [p.36-37]

6.3.1 Order Book & Wholesale Trading

As earlier described, the transaction fee for Eurex products is divided into two columns, order book and wholesale. Regular placed orders of standardized Eurex products are entered in the order book.

On the other hand, customized trades are entered as Eurex form of OTC trading, **wholesale trading**. It allows participants higher flexibility and customized trades as in an OTC trading, but is still associated to clearing standards and settlements of the Eurex. Through the wholesale trading, participants can benefit from several advantages such as still placing customized orders (size, maturity,...), maintain flexibility and benefit from reduced default risk through standardized clearing and settlement.⁷⁶

6.3.2 Volume rebates

As a matter of fact, Eurex grants potential members rebates on trading volumes. However, these rebates are only offered for some designated futures and options contracts. Further, a certain trading volume needs to be reached per month as well to trigger the rebate.

The volume rebate is only available for equity index, interest rate futures and a few specifically selected options. Also, futures possess three possible volume rebate levels, varying from 10 to 30 percent, which will become effective if the specified volumes are reached or exceeded. These rebates only apply to standardized trading's placed in the order book.

Product Group	Order Book Volume		
	Level 1	Level 2	Level 3
Rebate	10%	20%	30%
Equity Index Futures	200.001	300.001	400.001
Interest Rate Futures	300.001	600.001	1.200.001

Source: http://www.eurexchange.com/trading/fees_en.html (08-03-11)

In contrast, options are divided in five volume levels with rebates varying from 20 to 80 percent. Furthermore, these rebates apply for options that are not only placed in the order book, but also in the wholesale trading. Every option is a specific volume assigned as it can be seen in the table below. Thus, a level one rebate for equity options requires a minimum

⁷⁶ http://www.eurexchange.com/download/institutional/Eurex_OTC_Wholesale_Trade_Facilities.pdf (08-03-11)

trading volume of 80,001 contracts and a maximum volume of 160,000 contracts before the second level become effective.⁷⁷

6.3.3 Transaction fees – Options vs. futures

Apart from fees that are charged for delivery and storage of commodity products, Eurex maintains almost equal transaction fees for all of their options and futures. Though, a direct comparison is difficult due to the fact that for most of the products exist whether futures or options only. Also, different currencies do not allow to make direct comparison.

Nevertheless, for the product group equity index derivatives it is possible, since options and futures intersect. Thereby, the fees for futures are for numerous index derivatives (f.e. SMI, SMIM, SLI, MSCI) much lower than for options.⁷⁸

⁷⁷ http://www.eurexchange.com/trading/fees_en.html (08-03-11)

Appendix 3.5 – Eurex rebate table (options)

⁷⁸ http://www.eurexchange.com/trading/fees_en.html (08-03-11)

7. LIFFE

The abbreviation LIFFE stands for the “London International Financial Futures and Option Exchange”. LIFFE was the largest British derivative market, established in 1982, denominating several derivatives in major world currencies. Almost 10 years later the derivative exchange merged with the London Trading Options Market (LTOM) to amplify their offering range by equity options and commodity derivatives. A further merge occurred in 1996, with the London Commodity Exchange (LCE) to add commodities to the offering range. In 2001, it became the third largest derivative market in the world. Before 2001, LIFFE closed its traditional trading pit, which embraced shouting, gesticulation and hand signs and switched to a more advanced electronic system. Later, in 2002, LIFFE became part of the Euronext.⁷⁹

7.1 NYSE LIFFE

Euronext was a fusion of three European stock exchanges, Amsterdam, Brussels and Paris to form the first cross-border derivative exchange in Europe in 2000. Clearly, its purpose was to lower transaction costs, have less uncomplicated transactions as well as more liquidity.



Two years later, the Euronext amplified by the merger of LIFFE and the Portuguese derivative market Bolsa de Valores de Lisboa e Porto (BVLV) and formed the Euronext.Liffe offering a wide array of option and futures product lines. In 2007, Euronext merged with the New York Stock Exchange Group to shape the Euronext Group, today one of the strongest Pan-European derivative markets in the world. Even one year later, in 2008, NYSE Euronext took over the American Stock Exchange (AMEX), forming a greater Pan-European Exchange. The former LIFFE is now accessible under the name NYSE.Liffe.⁸⁰

⁷⁹ <http://chartango.com/Service/DataServices/tabid/60/ctl/Detail/ID/c8e79657-ab4f-42f6-a703-a6dca06f464b/mid/419/Default.aspx> (21-01-11)

R.R.Warendorf, 2000, *All About Futures – The easy way to get started*. 2nd edition. New York: McGraw Hill [p.204]

<http://www.euronext.com/editorial/wide/faq-3908-NL.html> (01-03-11)

http://www.worldlingo.com/ma/enwiki/en/London_International_Futures_and_Options_Exchange (01-03-11)

<http://www.articlesbase.com/investing-articles/euronext-liffe-history-2853146.html> (01-03-11)

⁸⁰ www.awpagesociety.com/images/uploads/Euronext_case.doc (21-01-11)

<http://www.euronext.com/editorial/wide/faq-3908-NL.html> (01-03-11)

<http://www.worldlingo.com/ma/enwiki/en/Euronext> (01-03-11)

7.2 Product range

NYSE.Liffe offers a wide product range, distributed via six product lines: short term interest rates, bonds, swaps, equities, commodities and currencies.⁸¹

The first group represents bond derivatives. These include mainly UK and Japanese government bonds at long, medium or short-term exposures traded in futures contracts, except for long-term bonds that can also be traded as options. These bond derivatives are traded on the London exchange market of NYSE.Liffe.⁸²

Contract list

- ▶ Long Gilt Futures
- ▶ Long Gilt Options
- ▶ Medium Gilt Futures
- ▶ Short Gilt Futures
- ▶ Japanese Government Bond (JGB) Futures

Contract list

- ▶ Cocoa Futures
- ▶ Cocoa Options
- ▶ Robusta Coffee Futures (No. 409)
- ▶ Robusta Coffee Options
- ▶ Corn Futures
- ▶ Corn Options
- ▶ Malting Barley Futures
- ▶ Malting Barley Options
- ▶ Rapeseed Futures
- ▶ Rapeseed Options
- ▶ Raw Sugar Futures
- ▶ Raw Sugar Options
- ▶ White Sugar Futures
- ▶ White Sugar Options
- ▶ Feed Wheat Futures
- ▶ Feed Wheat Options
- ▶ Milling Wheat Futures
- ▶ Milling Wheat Options
- ▶ SMP Futures

The second product group shows commodities. NYSE Liffe offers futures and options on various different commodities such as cocoa, coffee, sugar, seeds and wheat (table to the left). In comparison to Eurex, Liffe provides options on all their commodities as well.

Recently, Malting Barley has been added to the list as well as skimmed milk powder (SMP), which is only available for futures trading.

The supply of malting barley futures and options shall enable brewers and distillers a unique offer to hedge and pursue actively risk management. Also, NYSE.Liffe considered the skimmed milk powder futures contract as a new manageable tool for effective hedging and risk management of dairy products.⁸³

Besides bonds and commodities, NYSE.Liffe provides currency futures and options. Though, the currency derivatives are only in

Contract list

- ▶ US Dollar / Euro Futures
- ▶ US Dollar / Euro Options
- ▶ Euro / US Dollar Futures
- ▶ Euro / US Dollar Options

<http://www.nyse.com/about/1088808971270.html> (01-03-11)

http://www.finfacts.com/irelandbusinessnews/publish/article_10006084.shtml (01-03-11)

http://www.euronext.com/news/press_release/press_release-1731-EN.html?docid=600501 (01-03-11)

⁸¹ <http://www.euronext.com/editorial/wide/editorial-3997-EN.html> (09-03-11)

⁸² <http://www.euronext.com/landing/landingInfo-2037-EN.html> (09-03-11)

⁸³ <http://www.euronext.com/landing/landingInfo-3127-EN.html> (09-03-11)

Euros and Dollars, producing two choices of products for futures and options due to its reciprocal.⁸⁴

Additionally, NYSE.Liffe has ETF options in their product line-up. ETF's can be traded as shares with the risk of investment funds, as earlier explained in the Eurex chapter. Since they are dealt as fund assets, their value remains, in case of an insolvency of the emitter. Due to its flexibility and advantages, NYSE.Liffe provides a vast array of underlying indices (200) to choose from. These indices are clustered by asset class, index and issuer.⁸⁵

Further products of NYSE.Liffe are the short-term interest rate derivatives (STIRs). Identically, as for commodities, almost all STIR products can be traded by futures or options contracts. NYSE.Liffe STIR futures and options are denominated in Euro and Sterling, whereas one of the STIR is available in Japanese Yen.⁸⁶

Another derivative product of NYSE.Liffe with a vast range of futures and options describes the stock index, as it can be seen in the little overview to the right. The stock indices that NYSE.Liffe offers emerged from their own arrays. Through the merger with the Euronext group, NYSE Liffe contains leading European indices such as the Amsterdam Stock Index (AEX), the Brussels (BEL 20), the French (CAC 40), the Londoner (FTSE 100) and the Portuguese (PSI 20). An addition to all these indices constitutes the MSCI Pan-Euro Index, which is a partial quantity of the Morgan Stanley Capital International Europe Index. This global index measures the equity performance of 16 developed countries in Europe based on their indices and was formerly traded on the Liffe.⁸⁷

Contract list

- ▶ AEX Index Futures
- ▶ AEX Index Options
- ▶ AEX Index Daily Options
- ▶ AEX Index Weekly Options
- ▶ AEX Dividend Index Future
- ▶ BEL 20 Index Futures
- ▶ BEL 20 Index Options
- ▶ BEL 20 Index Option (BEL)
- ▶ CAC 40 Index Futures
- ▶ CAC 40 Index Options (PXA)
- ▶ CAC 40 Dividend Index Futures
- ▶ FTSE 100 Index Futures
- ▶ FTSE 100 Index Options (European Style)
- ▶ FTSE 100 Index FLEX Options (European Style)
- ▶ FTSE 100 Dividend Index Futures
- ▶ FTSE 250 Index Futures
- ▶ FTSE EPRA/NAREIT Europe Index Futures
- ▶ FTSE EPRA/NAREIT Eurozone Index Futures
- ▶ FTSE Eurotop 100 Index Futures
- ▶ FTSEurofirst 100 index futures
- ▶ FTSEurofirst 80 index futures
- ▶ MSCI Pan-Euro Index Futures
- ▶ PSI 20 Index Futures

⁸⁴ <http://www.euronext.com/landing/landingInfo-2123-EN.html> (09-03-11)

⁸⁵ <http://www.euronext.com/landing/landingInfo-1857-EN.html> (09-03-11)

<http://www.nasdaq.com/investing/etfs/what-are-ETFs.aspx> (09-03-11)

<http://www.finanztip.de/recht/bank/exchange-traded-funds-grundlagen.htm> (09-03-11)

<http://www.euronext.com/trader/pricelists/priceliststrackers-1821-EN.html> (09-03-11)

⁸⁶ <http://www.euronext.com/landing/landingInfo-2099-EN.html> (10-03-11)

⁸⁷ <http://www.euronext.com/landing/landingInfo-1896-EN.html> (10-03-11)

<http://invest.yourdictionary.com/msci-europe-index> (10-03-11)

http://www.msccibarra.com/eqb/pressreleases/archive/20010620_pr.pdf (10-03-11)

Stock future contracts available via NYSE Liffe:

- All stock futures
- Lisbon stock futures
- London stock futures
- Stock futures on Bclear

Moreover, single stock futures can be traded at NYSE.Liffe, which contain mainly stocks from companies listed on their London and Lisbon markets. Also, traders or business partners that prefer to trade off-exchange can use the Bclear service of NYSE.Liffe. The Bclear is Liffe's OTC trading possibility and have also standardized clearing and settlements as for their standardized products. This allows higher flexibility and reduced risk.⁸⁸

Besides stock futures, option contracts can be traded on single stocks as well. However, different than for futures, traders can have recourse to a list of 250 leading companies listed on the Amsterdam, London, Paris and Belgian markets.⁸⁹

Contract list

- ▶ Two-Year € Swapnote® Futures
- ▶ Two-Year € Swapnote® Options
- ▶ Five-Year € Swapnote® Futures
- ▶ Five-Year € Swapnote® Options
- ▶ Ten-Year € Swapnote® Futures
- ▶ Ten-Year € Swapnote® Options
- ▶ Two-Year \$ Swapnote® Futures
- ▶ Five-Year \$ Swapnote® Futures
- ▶ Ten-Year \$ Swapnote® Futures

At last, swapnotes can be traded on the NYSE.Liffe. The swapnotes are offered with durations of two, five and ten years in Euro or Dollars. Only Euro swapnotes are available as futures and options contracts. Further, as a specialty, the swapnotes are quoted as bonds, in particular with fixed maturities and a coupon rate.⁹⁰

NYSE Liffe offers a wide and international range of products that came by comprising the derivative markets in Amsterdam, London, Paris, Brussels and Lisbon. Similar to Eurex, most of the products are tradable as futures, but with a little tendency to an equal disposability. Nevertheless, NYSE Liffe provides less unique alternatives to trade that might attract more investors and enhance liquidity of certain products.

7.3 Trading volumes

The statistics of NYSE.Liffe show, as in the table below, how the trading volume developed over the last five years. Within these five years the trading volume grew by almost 70 percent. Clearly, a break in 2008, caused by the financial crisis, slowed down the growth. Only by 0.60

⁸⁸ http://www.euronext.com/news/press_release/press_release-1731-EN.html?docid=410952 (10-03-11)

<http://www.euronext.com/editorial/wide/editorial-4573-EN.html> (10-03-11)

⁸⁹ <http://www.euronext.com/landing/landingInfo-1834-EN.html> (10-03-11)

⁹⁰ <http://www.euronext.com/landing/landingInfo-2114-EN.html> (10-03-11)

percent increased the volume from 2008 to 2009. One year later the market recovered and trading volumes were up to 15 percent again.⁹¹

LIFFE DERIVATIVE MARKET - Trading Volume

Year	2006	2007	2008	2009	2010
Total Volume	730,303,126	949,021,974	1,049,729,625	1,056,012,096	1,222,556,772
<i>(without Bclear)</i>	677,504,596	826,246,159	858,855,235	795,061,757	881,716,555
<i>(which Bclear)</i>	52,798,530	122,775,815	190,874,390	260,950,339	340,840,217

Table 5 – Liffe trading volume 2006 - 2010⁹²

Also, it can be seen that the interest in the Bclear service developed positively within the last years. More and more investors and traders seem to be attracted by Liffe’s OTC trading with reduced risk and costs. These growths can be recognised by the graph below.

The red area shows how much of the total trading volume at NYSE.Liffe took place via the Bclear service while the blue bar shows the number of cleared contracts without Bclear. Further, the graph shows how trading stagnated in 2009, after the financial crisis, before it rose significantly again.⁹³

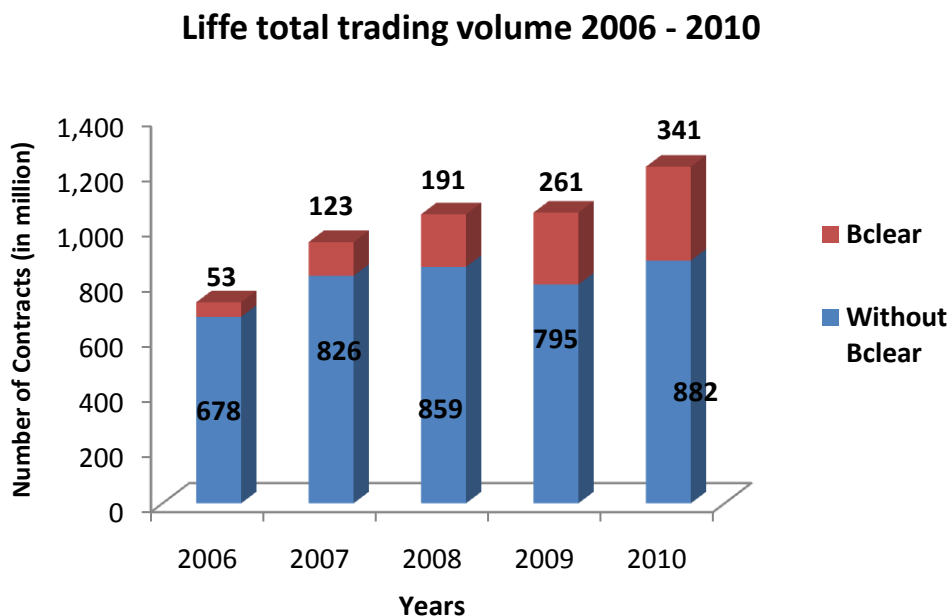

Figure 8 – Liffe trading volume 2006 – 2010 stacked bar chart

⁹¹ Appendix 4.1 – Liffe trading volumes growth rates
⁹² Appendix 4.2 – Liffe trading volume 2006 -2010
⁹³ Appendix 4.3 – Liffe trading volume distribution

In addition to that, the trading volume per segment shows a distinct trend for interest rate as well as equity derivatives in 2010. Almost 50 percent of the whole trading volume in 2010 consisted of interest rate derivatives, which includes all of NYSE.Liffe's STIR products. Another 40 percent of the trading volume for 2010 amounts to individual equity products, which comprise single stocks futures and options.⁹⁴

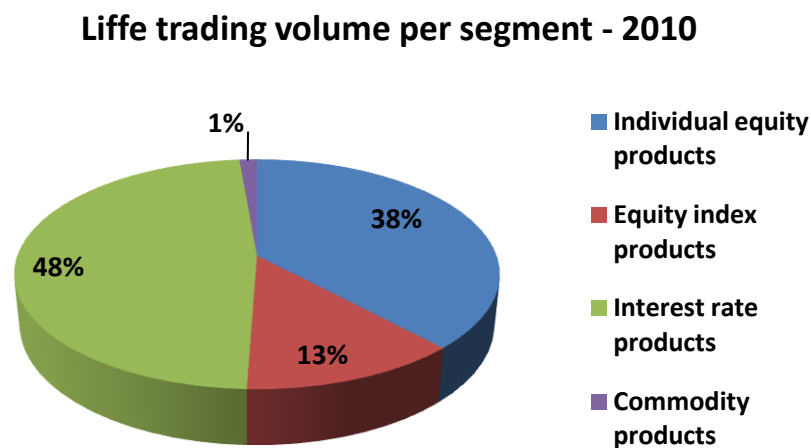

Figure 9 – Liffe trading volume per segment 2010 pie chart⁹⁴

Looking at the distribution of traded contracts between options and futures, it can be witnessed that in the last five years futures dominated the exchange. In 2010 was the number of cleared contracts for futures even twice as much as for options. Futures grew by 30 percent in trading volume from 2006 to 2007. Although, the financial crisis slowed down the growth in 2008 and 2009, futures reached almost 30 percent in 2010 again.

⁹⁴ Appendix 4.3 – Liffe trading volume distribution

Liffe Trading Volume Distribution - 2006 - 2010

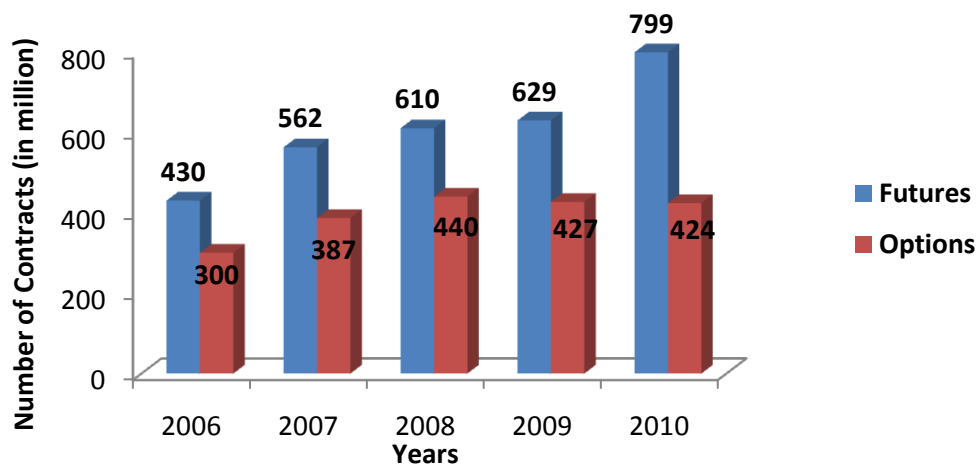

Figure 10 – Liffe trading volume distribution by options and futures

On the other hand, options that equally grew as futures by approximately 30 percent in 2007, had a stronger increment in 2008 than futures (14 % compared to 9 %). However, after 2008, option trading diminished by more than 15 million contracts (-3%). Also, in the following year, in 2010, option volume fell by additional three million contracts, while futures were up to approximately 30 percent again.⁹⁵

Although the trend for the bclear service increased over the last years, the amount of futures traded via the OTC trading exceeded options tremendously. Right after the issue of the OTC trading in 2005, the distribution between both was almost equal in 2006. Four years later, in 2010, futures represent 85 percent of the contracts traded via the bclear service of Liffe.⁹⁶

7.4 Trading fees⁹⁷

The trading fees for NYSE.Liffe products are divided into four big general groups such as commodities, equities, fixed income and OTC/Bclear services. The products that belong to each group can be withdrawn by the statistical references in the life market factbooks. Thus, equities include all individual equities such as single stocks futures and options as well as

⁹⁵ Appendix 4.3 – Liffe trading volume distribution

⁹⁶ Appendix 4.2 – Liffe trading volume 2006 -2010

⁹⁷ <http://www.euronext.com/editorial/wide/editorial-4123-EN.html> (11-03-11)

equity index derivatives. Furthermore, fixed income describes all interest rate products (STIRs).⁹⁸

The tables shown in the documents specify the product, the contract type and the corresponding costs. Below is an extract for commodity derivatives. Different than for Eurex, Liffe lists the clearing fees separately.

Commodity Derivatives – London Market

FUTURES AND OPTIONS CONTRACT	TRADING	CLEARING	EXERCISE/ASSIGNMENT
Futures – Cocoa*, Robusta Coffee, White Sugar and Feed Wheat	£0.50	£0.03	n/a
Options – Cocoa, Robusta Coffee, White Sugar and Feed Wheat	£0.50	£0.03	£0.075

Sources: <http://www.euronext.com/fic/000/061/576/615760.pdf> [p.5] (11-03-11)

Besides the separation of trading and clearing costs, additional costs can accrue. These are explicitly shown in the tables, for instance, options require an exercise fee, which does not apply for futures.

In an exceptional case, the stated fee can be accompanied by an additional penny or cent due to a charitable purpose such as for the futures contract on cocoa. The trading costs actually are stated £ 0.50, but instead cost £ 0.51 per contract. The extra penny is donated to a cocoa research association.⁹⁹

Furthermore, not only transaction fees are stated in the list. The costs for grading, delivery, lodging, approvals, analysis and others, are mentioned as well, which are mostly associated with commodity products, which require a physical delivery.

Generally, all trading fees are expressed as per lot per side (number of stocks, bonds, shares in a single trade) and do not demand a minimum number of contracts or volume. Mostly one contract implies 100 shares, except for the London order book; there equals one UK stock option 1,000 shares.¹⁰⁰

⁹⁸ <http://www.euronext.com/statistics/results/statistics-7327-EN.html?reportTitle=Euronext.liffe%20monthly%20statistics&reportSubTitle=%28NextMonth%29&type=7&displayMode=3> (11-03-11)

⁹⁹ <http://www.euronext.com/fic/000/061/576/615760.pdf> [p.5] (11-03-11)

¹⁰⁰ <http://www.euronext.com/fic/000/061/576/615760.pdf> [p.6-8] (11-03-11)

However, for some markets of Liffe, whether Amsterdam or Paris, “*prof transactions*” require a minimum of 250 contracts. These are special transactions for investors to progress trades of a remarkable size. Also, they imply a lower counterparty risk and no price disruptions, which are regularly caused by orders of a large size.¹⁰¹

According to the market, on which the derivative is traded, the respective currency changes. Hence, products traded on the London market of the NYSE.Liffe group will be denominated in pounds while on all other markets the prices will be in Euros (Amsterdam, Paris, Lisbon...).

In the equity category, fees are different than for commodities. As the example below demonstrates, the transaction fees for an option can change depending on the premium charged. Here, this applies only for Dutch Stock Options. Of course, the premium for an option is never fixed and change due to several influencing factors.¹⁰²

OPTIONS	TRADING FEE (PER LOT)				
	Premium	Broker (client account)	Member ² (own account)	Liquidity ³ Provider (Central Order Book)	Liquidity Provider Prof Transactions & Preferential Classes
Dutch Stock Options ⁴	≤ € 0.50	€0.75	€0.15	€0.04	€0.07
	> € 0.50	€0.75	€0.15	€0.07	€0.07
AEX-Index Options		€0.75	€0.15	€0.07	€0.07
Maximum Fee Per Order (including strategy orders) ⁵		€160	€80	€40	€40

Sources: <http://www.euronext.com/fic/000/061/576/615760.pdf> [p.7] (11-03-11)

Additionally, the fee for options depends on the account held. Registered members that trade via Liffe pay a lower fee than none-members or third parties whose account is maintained by a member or broker.

The liquidity provider is the third account next to the broker and member account. Liquidity providers, also known as market maker, are responsible for placing orders in the central order book in order to maintain the balance between buy and sell orders. This ensures a persistent liquidity, a fair as well as competitive market and to ease trading for financial instruments. Thus, these types of market makers pay lower fees than members and third parties. However,

¹⁰¹ <http://www.euronext.com/editorial/wide/editorial-4190-EN.html> (12-03-11)
<http://www.euronext.com/fic/000/059/906/599064.pdf> (12-03-11)

¹⁰² Appendix 1.1 – Basic of options, 1.10 – Factors influencing the option price

the fees for market makers are charged on a daily basis and before all other accounts. Their transaction fees can alternate depending on their performance, because they have to meet certain obligations.¹⁰³

Naturally, traders can place orders on their respective option or future contract as introduced in the swot-analysis of futures. These orders can be attached with certain functions as to trigger a buy or a sale of a contract as soon as a specified price has been reached. Also, they can have preferred execution before other orders as well as some other functions, which allows constructing useful strategies. Market makers pay the lowest amount for orders or strategy orders, as in the table above. The fee doubles for members and quadruplicates for non-members.

Some products offered at Liffe adapt the trading fee according to the order size. The French Stock Option, as exposed in the table below, pays € 0.06 per contract at a contract size of 10 shares and being smaller than 60,000 lots. However, if the order size is greater or equal to 60,000 lots, the transaction fee will cost € 160 for a client’s account (non-members or third party) and € 80 for own or market maker accounts.

PRODUCT	CONTRACT SIZE	ORDER SIZE ²	TRADING FEE
French Stock Options and ETF Options	10 shares	< 60,000 lots	€0.06 per contract
		≥ 60,000 lots	€160 per trade ³ €80 per trade ³
	100 shares	< 6,000 lots	€0.55 per contract
		≥ 6,000 lots	€160 per trade ³ €80 per trade ³

Sources: <http://www.euronext.com/fic/000/061/576/615760.pdf> [p.9] (11-03-11)

Furthermore, at Liffe reduced fees can be achieved through various packs and bundles for futures. These apply for trades in Euribor and Short Sterling futures only¹⁰⁴:

¹⁰³ <http://www.euronext.com/common/glossary/glossary-2214-EN.html?glossaryLetter=L> (11-03-11)
<http://www.euronext.com/editorial/wide/editorial-3089-EN.html> (11-03-11)
<http://www.euronext.com/fic/000/061/576/615760.pdf> [p.7] (11-03-11)
<http://www.euronext.com/fic/000/021/356/213563.pdf> [p. 4] (11-03-11)
¹⁰⁴ <http://www.euronext.com/fic/000/061/576/615760.pdf> [p.11] (11-03-11)

7.4.1 – Rebates

Packs and Bundles

STRATEGY	TRADING (PER SIDE, PER STRATEGY)	CLEARING
White Pack	£0.82	£0.08
Red Pack	£0.62	£0.08
Green Pack	£0.42	£0.08
Blue Pack	£0.00	£0.08
Gold Pack	£0.00	£0.08
Two Year Bundle	£1.04	£0.16
Three Year Bundle	£0.96	£0.24
Four Year Bundle	£0.88	£0.32
Five Year Bundle	£0.80	£0.40

Sources: <http://www.euronext.com/fic/000/061/576/615760.pdf> [p.9] (11-03-11)

There are five packs available:

- White Pack (first year)
- Red Pack (second year)
- Green Pack (third year)
- Blue Pack (fourth year)
- Gold Pack (fifth year)

There are four bundles available:

- Two Year Bundle
- Three Year Bundle
- Four Year Bundle
- Five Year Bundle

The packs include a buy or a sale in one trade at the same volumes. A white pack, for instance, entails a buy or sale for four successive months in one year. Bundles are a combination of packs. Therefore, a two year bundle covers a combination of the white and the red pack, buying or selling four futures in quarterly circles. Hereby, the white one covers the first year and the red one the second year.¹⁰⁵

7.4.2 – Transaction fees options vs. futures

A direct comparison of transaction fees for options and futures is almost impossible due to the different market segments and products they offer. Apparently, Liffe tries to maintain equal prices for both derivatives such as for commodities, swapnotes or Eurodollar, but these are exceptions. In some cases, the transaction fees for options appear to be more than futures, because of an exercise fee for options, while in others futures seem to be more expensive (AEX-index).

Nonetheless, Liffe compensates a few inequalities by setting up a cash settlement fee for futures equalling the exercise fee for options.

¹⁰⁵ <http://www.euronext.com/editorial/wide/editorial-4270-EN.html> (12-03-11)

However, one aspect favours futures, although options on commodities do not require a physical settlement and all the attached costs. The combination of packs and bundles is merely reserved for Euro and Sterling futures. Thus, the advantages of options or futures in terms of transaction fees depend on the product group, because they cannot be compared directly, most fees equal and rebates apply only for specific fixed income derivatives.¹⁰⁶

¹⁰⁶ <http://www.euronext.com/editorial/wide/editorial-4123-EN.html> (04-04-11)

8. Conclusion

The SWOT-analysis of financial options and futures as well as the view on the Eurex and the Liffe has shown that futures are the most convenient derivative for an entry, with preferences that point towards the Eurex.

However, options offer flexibility, limited risk and a great hedging potential to cover almost every market scenario and therefore, should not be underestimated. Although futures are more risky than options, simply the fact that futures are less complex and easy to understand represents a great advantage over options.

Even though futures might require some solvency to be able to be traded on the markets, still the high trading volumes (also for OTC trading) and the product ranges of the two exchanges clarify a trend for futures trading as well as underpin their convenience for an entry. Accordingly, the likelihood of finding an appropriate counterparty for futures trading is greater than for options due to the higher liquidities.

Despite of the fact that the transaction fees of Eurex and Liffe are difficult to be compared internally and that for many of their products the fees for futures and options are partially equal (probably to make them competitive), the transaction fees contribute mere slightly to the convenience comparison. Nevertheless, a few examples allow to be compared and the rebate systems (Liffe entirely, Eurex partially) favour futures, which further endorse its convenience.

Similarly, the higher trading volumes compared to Liffe as well as the all-round consistent transaction fees speak for an entry on the Eurex. Even though, Liffe could extend through the merger their product range considerably, it bets on tried and trusted products in combination with some unique offers, while Eurex ventures to amplify their product lines with extraordinary products, which however, had so far not a good start. Coupled with numerous reduced and rebate offers Eurex leaves Liffe behind, which reflects the difference in trading volume once again.

Nonetheless, despite the convenience for futures, it is crucial to study information as the examples about the oil-platform “Deepwater-Horizon” as well as the sick absence call of the CEO of Apple showed. It demonstrates how unstable and unsteady the markets can be and

that a little sickness of a CEO can let the market price drop significantly. With regard to such events, it does not even matter whether to trade options or futures, because such events can throw everything into disarray. Now, here one would attach the advantage of the risk limited option that can protect both sides whether the price falls or rises. Indeed, this is correct, and favours the convenience of options instead of futures. However, the downside is that such strategies in option trading are very complex and require certain knowledge and study, which shifts options back to not being convenient for an entry. As explained, several factors need to be considered in order to manage such strategy perfectly. Also, the lower liquidity for options does not contribute to that.

Notwithstanding that the results of the swot-analysis as well as the aspects of product range, trading volume and transaction fees of derivative markets favour indisputable a good commence for trading and entering the market by futures, preferably for an entry on the Eurex, several factors such as the research that showed more detailed information about options than futures as well as the partially equal transaction fees and rebate system of Eurex that gives greater discount on options products, points in the direction of options. Also, more option contracts were cleared in 2009 than futures. These aspects as well the competitive transaction pricing vaguely indicate that there are attempts of making option trading more comfortable/convenient for the future. Thus, it may, perforce, not be wrong to keep track of market movements with respect to options.

9. Recommendations

Generally, it can be said that both derivatives convey advantages and disadvantages that contribute to their convenience. Although, the convenience comparison of options and futures reinforced futures as the convenient derivative to enter preferentially the Eurex, options are recommendable to trade for an entry in some scenarios as well.

Apart from commission fees, options can be very cheap and cost as much as an expensive drink or a good dinner. Also, the limited risk and various strategies fit almost every market condition, which makes them a very secure derivative.

Apparently, this gives reason to look at the convenience of futures from different angles again.

Besides personal preferences plays wealth an important role in trading derivatives as well. The privilege what to do is still incumbent upon the investor, whether to be on a secure side when investing or to act chancy and speculate. If enough wealth is given to withstand a loss, then investments can be done abrasively and intuitively without considering the consequences.

On the other hand, those that may not be financially secured are not willing to risk everything. Their investments occur rather abstemious und hesitantly, which can be combined with the risk-limited options, which allow partially to assess profit and losses in advance. Also, the maximum loss is limited to the premium for most of the positions and strategies in options trading.

This aspect of wealth may also be associated with the level of risk-tolerance, which describes describe partially the trading behaviour and the degree of uncertainty towards higher level of risks, which intertwines with the level of wealth. Thus, someone that is risk-averse might favour options over futures, despite the fact that futures are easy and more convenient for an entry, because the risks of losing money are lower for options.

In addition to that, the analysis of the Eurex and the Liffe, in terms of product range, trading volume and transaction fees represent a few important aspects for a convenience comparison of options and futures. Naturally, other aspects should not be disregarded for an entry such as

member requirements, accessibility, and more. Moreover, the analysis about the transaction fees should be studied more thoroughly in order to extract valuable information that could not be covered by this analysis. However, some of these aspects represented here in this dissertation, serve as a good reference to build upon.

The further study is also an essential part to develop an own understanding of the markets. Even though investors, traders, etc. have access to millions of information via data platforms, the internet and other resources, our human memory is limited. Only a few of these tons of information are relevant in the event to appraise the situation and contribute to our understanding how the market adapts and changes to such situations, because: What if the traded securities already incorporate all the information that can be accessed? Prices are based on public information. The question that then might pop up is: How an individual can gain advantage of public information if everybody has the same access? Public information can be useless, because the odds are very high that one of the other thousands or millions of readers could already have purchased the option or future. Consequently, the price the underlying asset gets pushed up. Therefore, in conjunction with the comprehension of the markets, a certain speed of response is considered to be a valuable part as well.

At last, the comprehension process can be combined with courses or theoretical simulation of options and futures. Certainly, simulating options and futures trading can help to gain some practice before entering the market and suffer a painful (financially) loss. Knowledge can be gathered; mistakes found in advanced and build upon to avoid pitfalls in the future, because preparation is the key to success.

9.1 Critical reflections

Certainly, the research for this dissertation enhanced the personal knowledge in the field of options and futures. The comprehension could be amplified and new perceptions gained.

Further, the research for adequate information to accomplish the comparison between options and futures was very arduous. Despite the fact that plenty of books exist that helped to describe the basics of options and futures; none of them comprised a direct comparison between the two derivatives.

The view on the Eurex and Liffe was an interesting experience and rendered a new insight. However, personally, the procurement of data on their websites was very cumbersome, time-consuming and more difficult than prior assumed. The research was partially comparable to the search for the needle in the haystack, which was very frustrating. Both websites showed lack in transparency, especially NYSE Liffe, which gave reason to think about its credibility. On the other hand, a simple phone call at the service hotlines of the derivative exchanges might have reduced the finding process. This was done for Eurex, but ended after a few phone calls unsuccessfully.

However, the sheer amount of work that the complexity of this convenience comparison brought along was underestimated and caused a busy last week before the actual hand-in date. Also, due to large distances and holidays, the actual deadline had to be antedated one week ahead, causing additional hectic.

The planning on dissertation and the time that was necessary to elaborate the parts was not perfectly forecasted. Especially, on the fundamentals of options and futures too much time was spent. Also, with some additional planning, the conductance for primary data collection could have been implemented.

10. Bibliography

10.1 Books

C. Eck, M. Riechert, 2006, *Professionelles Eurex-Trading*. 3rd edition. München: FinanzBuch Verlag

M.H. Moffet, A.I. Stonehill, D.K. Eiteman, 2008, *Fundamentals of Multinational Finance*. 3rd edition. New Jersey: Prentice Hall

J.C. Hull, 2008, *Fundamentals of Futures and Option Markets*. 6th edition. New Jersey: Prentice Hall

R.R. Warendorf, 2000, *All About Futures – The easy way to get started*. 2nd edition. New York: McGraw Hill

M.Saunders, P. Lewis & A. Thornhill, 2003, *Research Methods for Business Students*. 3rd edition. New Jersey: Prentice Hall

I. Uszczapowski, 2008, *Optionen und Futures verstehen – Grundlagen und neue Entwicklungen*. 6th edition. München: Deutscher Taschenbuch Verlag

B. Rudolph, K. Schäfer, 2005, *Derivative Finanzmarktinstrumente*. Heidelberg: Springer-Verlag GmbH

D.J.Higham, 2004, *An Introduction to Financial Option Valuation*. Cambridge: Cambridge University Press

K.R.Trester, 2004, *101 Option trading secrets*. Lake Tahoe: Institute for Option Research Inc.

D.Kline, 2000, *Fundamentals of the futures market*. New York: McGraw Hill

L.-Waldock, 2005, *The Complete Guide to Futures Trading*. New Jersey: John Wiley & Sons Inc.

P.M.Johnson, 1999, *Derivatives, A manager's guide to the world's most powerful financial instrument*. New York: McGraw Hill

M.Williams, A.Hoffman, 2000, *Fundamentals of the Options market*. New York: McGraw Hill

R.Kolb,J.A.Overdahl, 2007, *Futures, Options and Swaps*. 5th edition. New Jersey: Wiley-Blackwell

10.2 Websites

NYSE Euronext, data about products, trading volume, and transaction fees, general information, <http://www.euronext.com>.

Eurex, data about products, trading volume, and transaction fees, general information, <http://www.eurexchange.com/>.

NYSE. Additional and general data for Euronext, <http://www.nyse.com/>

Bert H. Deiters (2003-2011), "Convenience Yield" y: die "Verfügbarkeitsrendite", <http://www.deifin.de/fuwi009c.htm>

The Options Industry Council (1998-2011), information about options strategies, <http://www.optionseducation.org/strategy/>

The options guide (2009), general information on options as well as strategies, <http://www.theoptionsguide.com/>

The Chicago Mercantile Exchange Group, general information about options and futures, <http://www.cmegroup.com/>

Appendices

APPENDIX 1 – FINANCIAL OPTIONS	73
APPENDIX 1.1 – BASIC TERMS AND CONCEPTS	73
APPENDIX 1.2 – OPTION TYPES AND BASIC POSITIONS	74
APPENDIX 1.3 – LEVERAGE EFFECT	75
APPENDIX 1.4 – OVER-THE-COUNTER.....	75
APPENDIX 1.5 – CALLS AND PUTS	75
<i>Appendix 1.5.1 – Call option</i>	76
<i>Appendix 1.5.2 – Put Option</i>	77
APPENDIX 1.6 – OPTIONS STATUS (ITM, ATM, OTM).....	79
APPENDIX 1.7 – BASIC POSITIONS (PROFIT & LOSS VIEW).....	80
<i>Appendix 1.7.1 – Buyer of a Call</i>	80
<i>Appendix 1.7.2 – Seller (Writer) of a Call</i>	82
<i>Appendix 1.7.3 – Buyer of a Put</i>	84
<i>Appendix 1.7.4 – Seller (Writer) of a Put</i>	85
APPENDIX 1.8 – OPTION PRICING & VALUATION	86
<i>Appendix 1.8.1 – Intrinsic Value</i>	86
<i>Appendix 1.8.2 – Time Value</i>	87
<i>Appendix 1.8.3 – Cost of an option</i>	89
APPENDIX 1.9 – ARBITRAGE.....	90
APPENDIX 1.10 – FACTORS INFLUENCING THE OPTION PRICE.....	90
<i>Appendix 1.10.1 – Volatility</i>	91
<i>Appendix 1.10.2 – Maturity</i>	91
<i>Appendix 1.10.3 – Risk-free interest rate</i>	92
APPENDIX 1.11 – BLACK-SCHOLES MODEL	93
<i>Appendix 1.11.2 – Volatility</i>	94
Appendix 1.11.2.1 – Historic Volatility.....	94
Appendix 1.11.2.2 – Implied Volatility	95
APPENDIX 1.12 – BINOMIAL MODEL	95
APPENDIX 1.13 – OPTION STRATEGIES.....	97
<i>Appendix 1.13.1 – Commissions/Transaction costs</i>	97
<i>Appendix 1.13.2 – Hedging Strategies</i>	97
APPENDIX 1.14 – SIMPLE HEDGING STRATEGIES.....	98
<i>Appendix 1.14.1 – Protective Call</i>	98
<i>Appendix 1.14.2 – Writing Covered Put</i>	100
APPENDIX 1.15 – COMPLEX HEDGING STRATEGIES.....	102
APPENDIX 1.15.1 – BULLISH STRATEGIES	102
Appendix 1.15.1.1 – Bull Call Spread	102
Appendix 1.15.1.2 – Ratio Call Spread	104
APPENDIX 1.15.2 – BEARISH STRATEGIES.....	106
<i>Appendix 1.15.2.1 – Bear Put Spread</i>	106
APPENDIX 1.15.3 – VOLATILITY STRATEGIES.....	108
Appendix 1.15.3.1 – Long Straddle	108
Appendix 1.15.3.1 – Long Strangle	109
APPENDIX 1.15.4 – NEUTRAL STRATEGIES.....	110
Appendix 1.15.4.1 – Long Butterfly Spread	110
Appendix 1.15.4.2 – Long Condor.....	112

APPENDIX 2 – FUTURES	114
APPENDIX 2.1 – WHAT ARE FORWARDS AND FUTURES?.....	114
APPENDIX 2.2 – CHARACTERISTICS OF FUTURES.....	116
<i>Appendix 2.2.1 – Positions</i>	116
<i>Appendix 2.2.2 – Settlement</i>	116
<i>Appendix 2.2.3 – Maturity</i>	117
<i>Appendix 2.2.4 – Contract Size</i>	117
<i>Appendix 2.2.5 – Ticks</i>	117
<i>Appendix 2.2.6 – Margin</i>	117
APPENDIX 2.3 – THE CLEARING HOUSE.....	118
APPENDIX 2.4 – BID AND ASK PRICES.....	119
APPENDIX 2.5 – COSTS OF FUTURES.....	120
<i>Appendix 2.5.1 – Cost of Carry</i>	120
<i>Appendix 2.5.2 – Transaction costs</i>	121
APPENDIX 2.6 – THE CONVERGENCE OF SPOT & FUTURE PRICE.....	121
APPENDIX 2.7 – FUTURES PRICING.....	122
<i>Appendix 2.7.1 – Cost of carry approach</i>	122
<i>Appendix 2.7.2 – Basic pricing</i>	124
<i>Appendix 2.7.3 – Dividend payments</i>	125
<i>Appendix 2.7.4 – Arbitrage relationships</i>	126
APPENDIX 2.8 – BASIC FUTURES STRATEGIES.....	128
<i>Appendix 2.8.1 – Going Long</i>	128
<i>Appendix 2.8.1 – Going Short</i>	129
APPENDIX 2.9 – ARBITRAGE FUTURES STRATEGIES.....	131
APPENDIX 3 – EUREX DATA	133
APPENDIX 3.1 – EUREX TRADING VOLUME GROWTH RATES.....	133
APPENDIX 3.2 – EUREX TRADING VOLUME 2006 - 2010.....	133
APPENDIX 3.3 – EUREX TRADING VOLUME 2010 BY PRODUCT GROUP.....	134
APPENDIX 3.4 – EUREX TRADING VOLUME DISTRIBUTION.....	135
APPENDIX 3.5 – EUREX REBATE TABLE (OPTIONS).....	136
APPENDIX 4 – LIFFE DATA	137
APPENDIX 4.1 – LIFFE TRADING VOLUME GROWTH RATES.....	137
APPENDIX 4.2 – LIFFE TRADING VOLUME 2006 - 2010.....	138
APPENDIX 4.3 – LIFFE TRADING VOLUME DISTRIBUTION 2006 - 2010.....	140

Appendix 1 – Financial Options

Appendix 1.1 – Basic terms and concepts

Basically there are two different types of option contracts: **call options** and **put options**. The owner of an option, depending on which option type is held, is permitted, but not obligated to buy (call) or sell (put) an **underlying asset** or **underlying security** at a fixed price on or until a certain date.

Always two parties participate in an option contract, one is the buyer and the other one is the seller or writer of the option. The base price or value of a derivative such as financial options depends on the underlying asset. As the name indicates, the value for derivatives partly derives from the underlying asset.

Moreover, the fixed price of the option contract is known as the **exercise price** or the **strike price** at which the buyer (seller) is permitted to purchase (sell) the option.

The costs or purchase price of an option is the **premium**, which an investor has to pay the issuer or writer of the option. Principally, the premium for a stock option is quoted in a currency per share and most contracts reflect an amount of 100 shares. Regularly, the price of a premium is determined through a few factors such as the base price of the underlying asset, the time of the option until maturity, the interest rate during the contract period, and the volatility of the underlying asset.

Additionally, the future date at or until the asset can be purchased or sold is the **expiration date**. Other synonyms for the expiration dates are **maturity date** or **exercise date**.¹⁰⁷

¹⁰⁷ <http://www.ameinfo.com/87105.html> (14-02-11)

C. Eck, M. Riechert, 2006, *Professionelles Eurex-Trading*. 3rd edition. München: FinanzBuch Verlag [p.41-42]

J.C. Hull, 2008, *Fundamentals of Futures and Option Markets*. 6th edition. New Jersey: Prentice Hall [p.185]

M.H. Moffet, A.I. Stonehill, D.K. Eiteman, 2008, *Fundamentals of Multinational Finance*. 3rd edition. New Jersey: Prentice Hall [p.223-225]

Appendix 1.2 – Option types and basic positions

In correlation with the maturity date, options divide themselves in two types:

- European-style Option
- American-style Option

The call or put option can be a **European-style** or an **American-style** option. With a European-style option the owner can exercise the option only on the maturity date while with an American-style option the owner is allowed after the purchased to exercise the option at any time before the maturity.¹⁰⁸

Also, two distinct option positions have to be memorised when looking at calls and puts. Depending on buying or selling an option, four viewpoints emerge:

- 1) Buyer of a Call (**Long Call**)
- 2) Seller of a Call (**Short Call**)
- 3) Buyer of a Put (**Long Put**)
- 4) Seller of a Put (**Short Put**)

A buyer of a call (put) option is referred to have a **long position** while contrary the seller of a put option takes a **short position**. The trader in the long position is related to the one who has more pull (the right to exercise or not). Generally, selling an option is on equal terms with **writing an option** as earlier explained.¹⁰⁹

¹⁰⁸ <http://www.ameinfo.com/87105.html> (14-02-11)

C. Eck, M. Riechert, 2006, *Professionelles Eurex-Trading*. 3rd edition. München: FinanzBuch Verlag [p.41-42]

J.C. Hull, 2008, *Fundamentals of Futures and Option Markets*. 6th edition. New Jersey: Prentice Hall [p.185]

M.H. Moffet, A.I. Stonehill, D.K. Eiteman, 2008, *Fundamentals of Multinational Finance*. 3rd edition. New Jersey: Prentice Hall [p.223-225]

Uszczapowski, 2008, *Optionen und Futures verstehen – Grundlagen und neue Entwicklungen*. 6th edition. München: Deutscher Taschenbuch Verlag [p. 47]

¹⁰⁹ Uszczapowski, 2008, *Optionen und Futures verstehen – Grundlagen und neue Entwicklungen*. 6th edition. München: Deutscher Taschenbuch Verlag [p. 45-46]

http://www.finanz-lexikon.de/long%20call_3452.html (14-02-11)

Appendix 1.3 – Leverage effect

Furthermore, options, but also futures are known for the **leverage effect**. This financial term depicts a situation in which a little variation of a variable has a tremendous impact on the result. With a small capital investment the options or futures can lever the amount to a multiple of its investment, much higher than the possible gain through a direct investment in the underlying asset. An investor can purchase, for instance, for € 1,000 100 shares of company ABC, but with the same amount, two option contracts at a price of € 5, holding each 100 shares of company ABC ($2 \times €5 \times 100 \text{ shares} = € 1,000$).¹¹⁰

Appendix 1.4 – Over-the-Counter

Another option of derivative trading, apart from the derivative exchanges, is the over-the-counter (OTC) trading, which trades specific or customized derivatives via an electronically dealer network. The OTC market has no physical location as the derivative exchanges. Merely private investors and financial institution trade OTC. Different than for exchange-traded markets are OTC trading less standardized and unregulated.

OTC trading offers an advantage for small companies that are not able to meet the requirements for exchange markets. Also, OTC trading is flexible, since the parties are able to negotiate their own contract agreements such as size, strike price and others. Nonetheless, OTC trading involves a high credit risk, because the counterparty can default, and no clearing house¹¹¹ is entailed to reduce credit risk. Nowadays, derivative exchanges provide their clients OTC trading with reduced credit risk through a clearing house.¹¹²

Appendix 1.5 – Calls and Puts

The denotation of long and short position will play an important role when understanding option strategies, but before coming to that point, it is necessary to understand how a call and a put option works.

¹¹⁰ <http://www.ameinfo.com/87105.html> (14-02-11)

Uszczapowski, 2008, *Optionen und Futures verstehen – Grundlagen und neue Entwicklungen*. 6th edition. München: Deutscher Taschenbuch Verlag [p. 58]

¹¹¹ See Appendix – 2.3 The Clearing House

¹¹² J.C. Hull, 2008, *Fundamentals of Futures and Option Markets*. 6th edition. New Jersey: Prentice Hall [p.203]
P.M.Johnson, 1999, *Derivatives, A manager's guide to the world's most powerful financial instrument*. New York: McGraw Hill [114-116]

Appendix 1.5.1 – Call option

The call option gives the buyer the right, but not the obligation, to buy a part, amount or quantity of an underlying asset. These underlying assets can vary between several financial instruments such as indices, commodities, stocks, currencies and others.¹¹³

Further, the call option can be bought to a fixed price of the underlying asset. Through the execution of the option, the buyer of a call can purchase the prior defined quantity to a fixed price, the strike price. Also, the buyer of a call option assumes that the price of the underlying asset will grow in the future. Otherwise, there will not be any profit, only a loss in form of the premium paid for the option.

On the other hand, the seller of the call option hopes that the price of the underlying asset will not increase in the future, because otherwise the seller faces a loss. The writer can only hope that the option expires worthless and he can pocket the premium received for the option.¹¹⁴

EXAMPLE: Call-option (European-Style: can only be exercised at maturity)

Mr. A wants to buy a harvester. Mr. B offers a harvester. Mr. A can buy it immediately for € 90,000. However, Mr. A wants to wait one week to revise some other price offers, in order to choose the best one. Mr. B confirms and gives him one week time before making a choice. Nevertheless, Mr. B demands € 1,000 (premium) of Mr. A to keep the offer reserved:

Mr. A		Mr. B	
Buys Call Option		Sells the Call Option	
Strike price	90,000 €		
Premium	1,000 €	→	1,000 €
Duration	1 Week		

¹¹³ <http://www.theoptions.net/tag/underlying-asset-of-option/> (31-01-11)

M.Williams, A.Hoffman, 2000, *Fundamentals of the Options market*. New York: McGraw Hill [p.11]

¹¹⁴ C. Eck, M. Riechert, 2006, *Professionelles Eurex-Trading*. 3rd edition. München: FinanzBuch Verlag [43-44]
J.C. Hull, 2008, *Fundamentals of Futures and Option Markets*. 6th edition. New Jersey: Prentice Hall [p.185-186]

M.Williams, A.Hoffman, 2000, *Fundamentals of the Options market*. New York: McGraw Hill [p.11-12]

After one week:

Prices of harvesters on the market:
≥ 95,000 €



<u>Exercises the Option</u>		<u>Receives</u>	
Premium	1,000 €	1,000 €	Premium
Strike Price	90,000 €	90,000 €	Price
Total	91,000 €	91,000 €	Total
minimum			
Market Price	95,000 €		
Advantage	4,000 €		

Since the market prices for harvesters are all higher than the offer from Mr. B, Mr. A exercises the option and buys the harvester for € 90,000. Further, Mr. A took the risk and reserved the offer from Mr. B in exchange for the premium. If the price would have been below the € 90,000 by the end of the week, Mr. A would not have exercised the option and would have lost the costs for the option of € 1,000. Nonetheless, in the end he could save 4,000 € with the call option he bought.

Clearly, the example demonstrated, a call-option has advantages and disadvantages. Whether to exercise the option or not, depends on how the market price develops during the time until maturity. If the market price of the underlying asset is higher than the strike at maturity, it will make sense to exercise the option. On the other hand, if the market price is below the strike price, it will not be worth to exercise the option. The harvester could be bought on the market for a cheaper price. As a disadvantage, the buyer would lose the costs of the option, the premium.¹¹⁵

Appendix 1.5.2 – Put Option

The principles of a put option are converse to a call option. In a put option, the buyer has the right to sell a quantity of an underlying asset to a fixed price (strike price) to the seller of the option at or before maturity (depends on American or European-style option).

¹¹⁵ C. Eck, M. Riechert, 2006, *Professionelles Eurex-Trading*. 3rd edition. München: FinanzBuch Verlag [p.44]

Also, different than in a call, the buyer of a put speculates on a price fall of the underlying asset in the future. If the price falls below the strike price, the buyer can sell the underlying asset to the strike price and re-purchase it for a cheaper price, benefitting from the difference.

Contrary, the seller (writer) of the put option hopes that the price will increase or stagnate; because only then the chance exists that the option expires worthless for the buyer, leaving the seller with the profit of the premiums.

In order to understand the steps and process involved in a put option the example with the harvester will be rerun.¹¹⁶

EXAMPLE: Put-option (European-Style)

Mr. A bought a harvester from Mr. B. Now, Mr. A built a barn for his vehicle for € 100,000. He wants to insure the barn for € 150,000 for one year to protect it against climate impacts, because he assumes a climatic year and fears to lose the barn in a heavy storm. The costs (premium) to insure the barn amount to 2,000 €.

Mr. A		Insurance Company
Put Option		Offers Put Option
Value Barn	100,000 €	
Strike price	150,000 €	
Premium	2,000 €	→ 2,000 €
Duration	1 Year	
A little later		
Barn burns down		
↓		
Exercises the Option		
Premium	2,000 €	
Strike Price	150,000 €	
Total	148,000 €	
Value of the barn	100,000 €	
Advantage	48,000 €	

¹¹⁶ M. Williams, A. Hoffman, 2000, *Fundamentals of the Options market*. New York: McGraw Hill [p.12-13]
C. Eck, M. Riechert, 2006, *Professionelles Eurex-Trading*. 3rd edition. München: FinanzBuch Verlag [44-45]
J.C. Hull, 2008, *Fundamentals of Futures and Option Markets*. 6th edition. New Jersey: Prentice Hall [p.187]

After six month, the barn burned down entirely, caused by a lightning strike of a heavy storm. Thus, the barn dropped in value. The put option can be set equal to an insurance option. Mr. A used his right and sold the option (barn) to the agreed price of 150,000 € to the insurance company less the premium, he paid for the insurance option.

The concept behind a put option is that the buyer assumes the prices of the underlying asset will drop. If the price falls below the strike price of the option, the buyer will exercise the option and re-purchase it on the market for a cheaper price. In case the market price rises above the base value of the underlying asset, the option becomes worthless, because the option will be sold at the strike price (cheaper) than the current market price.¹¹⁷

Appendix 1.6 – Options status (ITM, ATM, OTM)

In option trading, a few concepts describe the status of an option, which helps to classify them. An option can be **in-the-money (ITM)**, **at-the-money (ATM)** or **out-of-the-money (OTM)**. These three terms are related to the strike price of an option.

At first, an option is said to be ITM, when the spot price of the underlying asset is above the strike price (call option) or below the strike price (put option). The call option, for example, will be profitable when exercised, because the call will be bought at the lower strike price and can be sold at the higher spot price on the market (profiting from the difference, see table below).

At second, when the spot price equals the strike price of the option then the option is ATM. The trader makes no gain and no losses on the option. Sometimes, ATM is also said when the price of the underlying asset is near the strike price of the option.

At last, an option is OTM, when the spot price is below the strike price (call option) or above the strike price (put option). The buyer of a call or put still has the right to exercise the option. However, in case of exercising a put option OTM, the trader would sell the option to a cheap price and would only be able to re-buy at a higher price, leaving a loss in difference.¹¹⁸

¹¹⁷ C. Eck, M. Riechert, 2006, *Professionelles Eurex-Trading*. 3rd edition. München: FinanzBuch Verlag [p.45]

¹¹⁸ M.H. Moffet, A.I. Stonehill, D.K. Eiteman, 2008, *Fundamentals of Multinational Finance*. 3rd edition. New Jersey: Prentice Hall [224]

M.Williams, A.Hoffman, 2000, *Fundamentals of the Options market*. New York: McGraw Hill [p.38-39]

C. Eck, M. Riechert, 2006, *Professionelles Eurex-Trading*. 3rd edition. München: FinanzBuch Verlag [p.56]

J.C. Hull, 2008, *Fundamentals of Futures and Option Markets*. 6th edition. New Jersey: Prentice Hall [p.193]

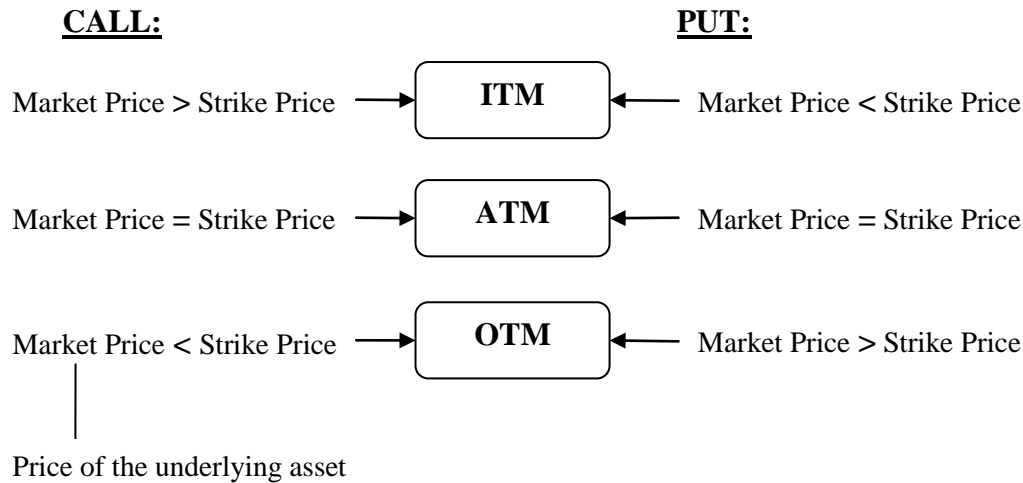

Appendix 1.7 – Basic Positions (Profit & Loss view)

Naturally, the buyer or seller of an option contract strives for a profit, but he has to consider the risks before making any decision. Hence, it is useful to look at the maximum profit and losses when establishing an option position. The graphs and tables below will introduce the four basic viewpoints of option positions that were mentioned earlier. Moreover, in the explanations it is assumed that the options are European-style and can only be exercised at maturity. At first, the buyer and the seller of a call-option will be viewed followed by the buyer and the seller of a put option.

Appendix 1.7.1 – Buyer of a Call¹¹⁹

The buyer of a call-option, **long call**, purchases an underlying asset for certain quantity and fixed price for a specific time period. In order to get a deeper view insight and an advanced understanding of options, are the following graphs via currency options (Euro/US \$) explained.

As an example, assume the purchase of a *European-style* call option, with a premium of \$0.005 and an exercise price of \$1.335. Note, the time until maturity will not be directly specified here. Nevertheless, this option will be due at a certain point in time.

¹¹⁹ M.H. Moffet, A.I. Stonehill, D.K. Eiteman, 2008, *Fundamentals of Multinational Finance*. 3rd edition. New Jersey: Prentice Hall [229-230]

C. Eck, M. Riechert, 2006, *Professionelles Eurex-Trading*. 3rd edition. München: FinanzBuch Verlag [p.47-48]

Regularly, options are offered at plentiful different strike prices, depending on the interest in the underlying asset. With the different strike prices vary also the price (premium) to purchase the option. In this and the following examples are diverse possible outcomes illustrated. Thus, the table below demonstrates a few possible spot prices at maturity and how the payoff for the buyer would look like.

Buying a CALL Option on Euros							
Cost of the Call Option		\$0.005					
Strike Price		\$1.335					
Spot Prices of Euro (US \$) at Maturity		\$1.320	\$1.330	\$1.335	\$1.340	\$1.350	\$1.360
Buyer's Payoff for Call Option (U.S. cents/Euro)		-\$0.500	-\$0.500	-\$0.500	\$0.000	\$1.000	\$2.000
Status		OTM	OTM	ATM	BEP	ITM	ITM
Exercise		No	No	No	Yes	Yes	Yes

From the table can be withdrawn that if the spot price turns out to be lower than (OTM) or at the strike price (ATM), the buyer will preferably not exercise the option. Justifiably, at these spot prices the buyer will not make any profit. The buyer's loss (payoff) will be limited to the premium. This can be simply calculated:

$$\text{Profit (Loss)} = \text{Spot price} - \text{Strike Price} - \text{Premium}$$

At a spot price of \$1.340, the buyer would break-even and would exercise the option, because the spot is slightly higher than the exercise price and could cover the costs of the purchase. The option can be bought at a cheaper price of \$1.335 (through the option) and sold on the market for \$1.340. Less the premium, the payoff will be zero.

If the spot price will pass the break-even point, the option runs in-the-money. The higher the final spot price will be at maturity, the more the buyer can profit from the margin. At a spot price of \$ 1.360, deducting the strike and the premium, the option is worth \$2.000 cents per Euro.

Buyer of a Call - Long Call

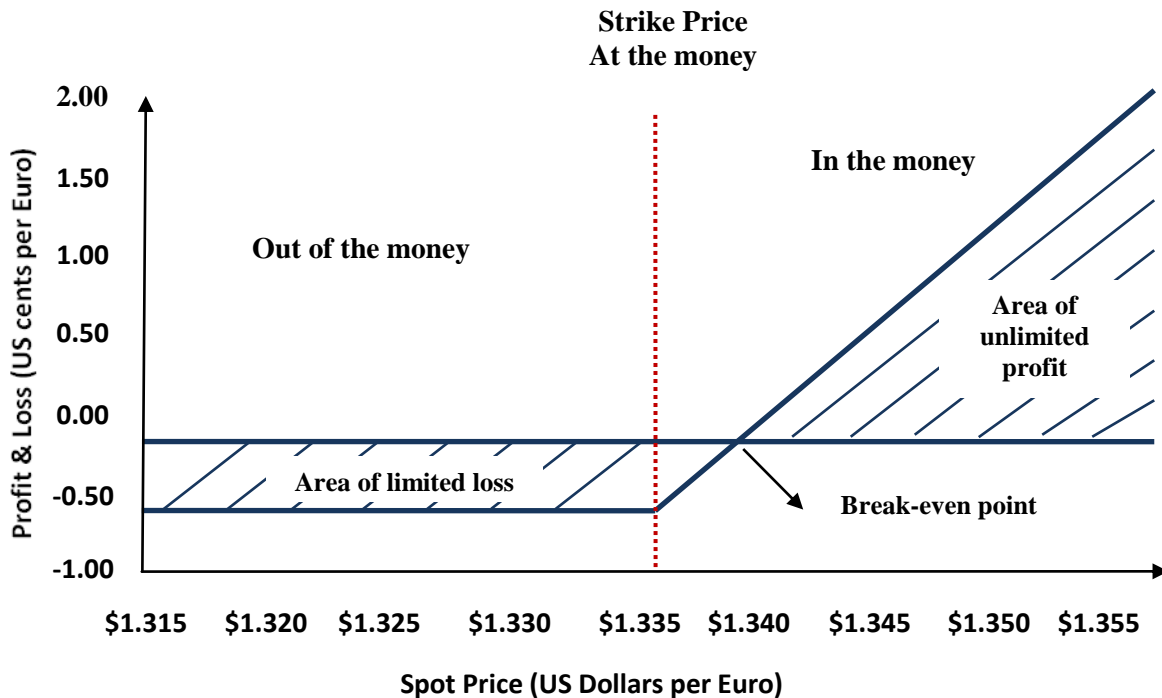

To be the buyer of a call option (long call) possesses the advantage of losing minimal the premium of the option. Certainly, this can change if additional positions are involved, but if the spot emerges to be in the money, the profit can be unlimited.

Appendix 1.7.2 – Seller (Writer) of a Call¹²⁰

When one is speaking of a **short call**, then one is referring to the seller of a call option. In a short position, the seller has no right to exercise the option. Furthermore, the outcome for the seller depends on how the market price develops and how the buyer of the option will behave. Therefore, all results will stand in contrast to the buyer’s payoff.

¹²⁰ M.H. Moffet, A.I. Stonehill, D.K. Eiteman, 2008, *Fundamentals of Multinational Finance*. 3rd edition. New Jersey: Prentice Hall [230-231]

C. Eck, M. Riechert, 2006, *Professionelles Eurex-Trading*. 3rd edition. München: FinanzBuch Verlag [p.49-51]

Selling a CALL Option on Euros							
Cost of the Call Option		\$0.005					
Strike Price		\$1.335					
Spot Prices of Euro (US \$) at Maturity		\$1.320	\$1.330	\$1.335	\$1.340	\$1.350	\$1.360
Seller's Payoff for Call Option (U.S. cents/Euro)		\$0.500	\$0.500	\$0.500	\$0.000	-\$1.000	-\$2.000
Status		ITM	ITM	ATM	BEP	OTM	OTM
Exercise							

For the seller of the call option change the fields for the option status. Those spot prices that cause a negative payoff for the buyer are positive for the seller. Obviously, the maximum profit for the writer can only be the premium he receives for selling the option. However, he can only pocket the entire premium if the spot price stays below or at the strike price of the option.

$$\text{Profit (Loss)} = \text{Premium} - (\text{Spot price} - \text{Strike price})$$

The buyer as well as the seller will break-even if the spot price equals the strike plus the premium paid for the option. As soon as the spot price passes the strike price, the loss can become unlimited for the seller of the call, as it can be seen in the graph below. The option will be sold at a lower price to the buyer, who can re-sell at a higher price on the market. Of course, the seller of a call option prefers that the spot price will evolve to be lower than the exercise price, because only then the payoff will be in the money.

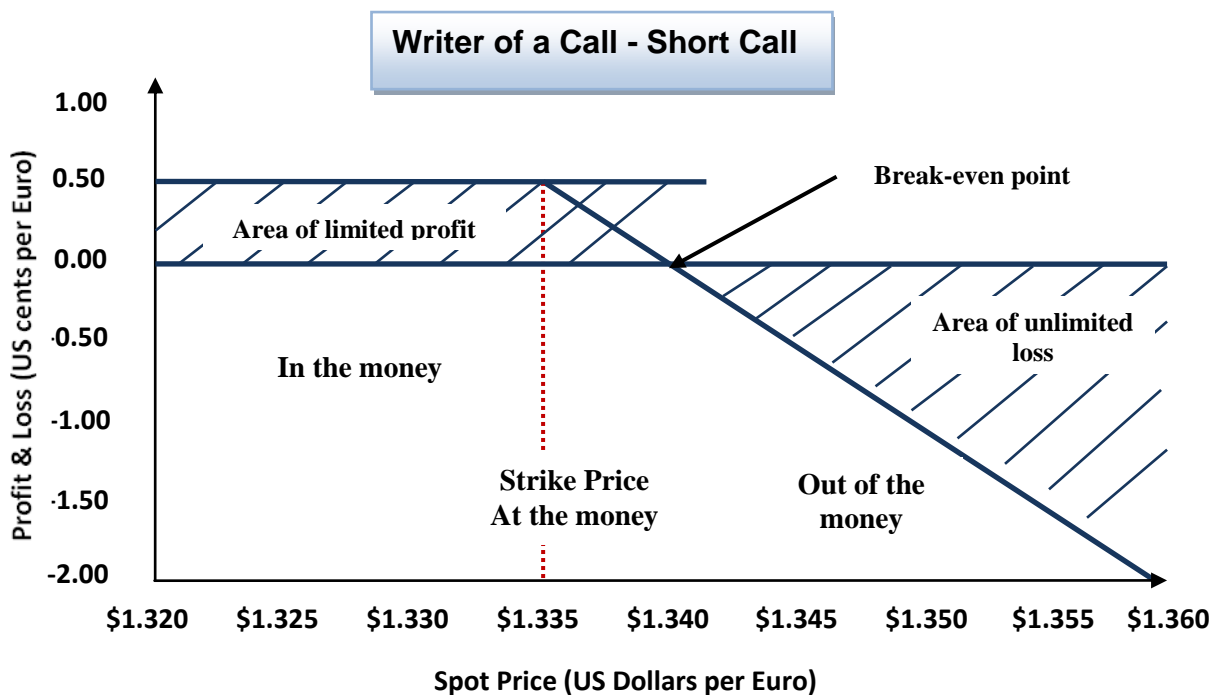

Appendix 1.7.3 – Buyer of a Put¹²¹

The buyer of a put option, the **long put**, favours spot prices that are lower than the exercise price. Considering the same initial position as for the call option, then the put option is only in the money when the spot price of the underlying asset is below the strike price.

Oppositely to the call option, the BEP is reached at a strike price less the premium. From the profit and loss determination for the buyer of a put can be seen that the payoff is only positive if the sum of the spot price and the premium is lower than the strike price.

$$\textit{Profit (Loss)} = \textit{Strike price} - \textit{Spot price} - \textit{Premium}$$

Buying a PUT Option on Euros							
Price of the Put Option		\$0.005					
Strike Price		\$1.335					
Spot Prices of Euro (US \$) at Maturity		\$1.310	\$1.320	\$1.330	\$1.335	\$1.340	\$1.350
Buyer's Payoff for Put Option (U.S. cents/Euro)		\$2.000	\$1.000	\$0.000	-\$0.500	-\$0.500	-\$0.500
Status		ITM	ITM	BEP	ATM	OTM	OTM
Exercise		Yes	Yes	Yes	No	No	No

Reverse to a call option, if the spot price exceeds the strike price of the put option, then the option is out of the money. The execution of the option seems worthless and the costs for the purchase of the option remain, amounting to \$ 0.500 cents per Euro. Even ATM, the option is worthless due to the premium. Nonetheless, the maximum loss for the buyer of a put option will always be the premium, if no additional positions are included that could alternate the payoff.

¹²¹ M.H. Moffet, A.I. Stonehill, D.K. Eiteman, 2008, *Fundamentals of Multinational Finance*. 3rd edition. New Jersey: Prentice Hall [231-232]

C. Eck, M. Riechert, 2006, *Professionelles Eurex-Trading*. 3rd edition. München: FinanzBuch Verlag [p.52-53]

Buyer of a Put - Long Put

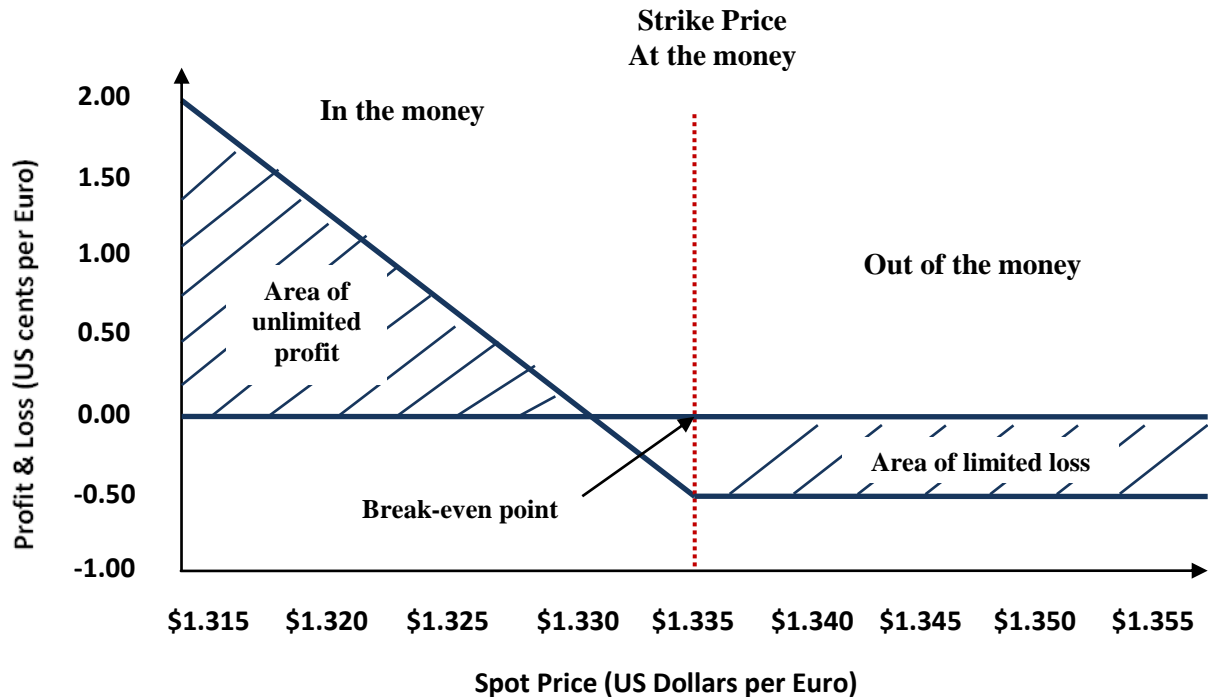

Appendix 1.7.4 – Seller (Writer) of a Put¹²²

For the writer of a put option, the **short put**, applies almost the same as for the writer of a call option. The seller of a put is hoping that the spot price will be at or higher than the exercise price at maturity. Again, for the seller of the put exists the same risk as for the seller of a call. The loss can become unlimited, if the spot price falls below the strike price.

$$Profit (Loss) = Premium - (Strike price - Spot price)$$

Selling a PUT Option on Euros							
Price of the Put Option		\$0.005					
Strike Price		\$1.335					
Spot Prices of Euro (US \$) at Maturity		\$1.310	\$1.320	\$1.330	\$1.335	\$1.340	\$1.350
Buyer's Payoff for Put Option (U.S. cents/Euro)		-\$2.000	-\$1.000	\$0.000	\$0.500	\$0.500	\$0.500
Status		OTM	OTM	BEP	ATM	ITM	ITM
Exercise							

¹²² M.H. Moffet, A.I. Stonehill, D.K. Eiteman, 2008, *Fundamentals of Multinational Finance*. 3rd edition. New Jersey: Prentice Hall [233-234]

C. Eck, M. Riechert, 2006, *Professionelles Eurex-Trading*. 3rd edition. München: FinanzBuch Verlag [p.54-55]

Only if the spot price stagnates and remains close to ATM or higher than the strike price, the seller will be able to profit the entire premium.

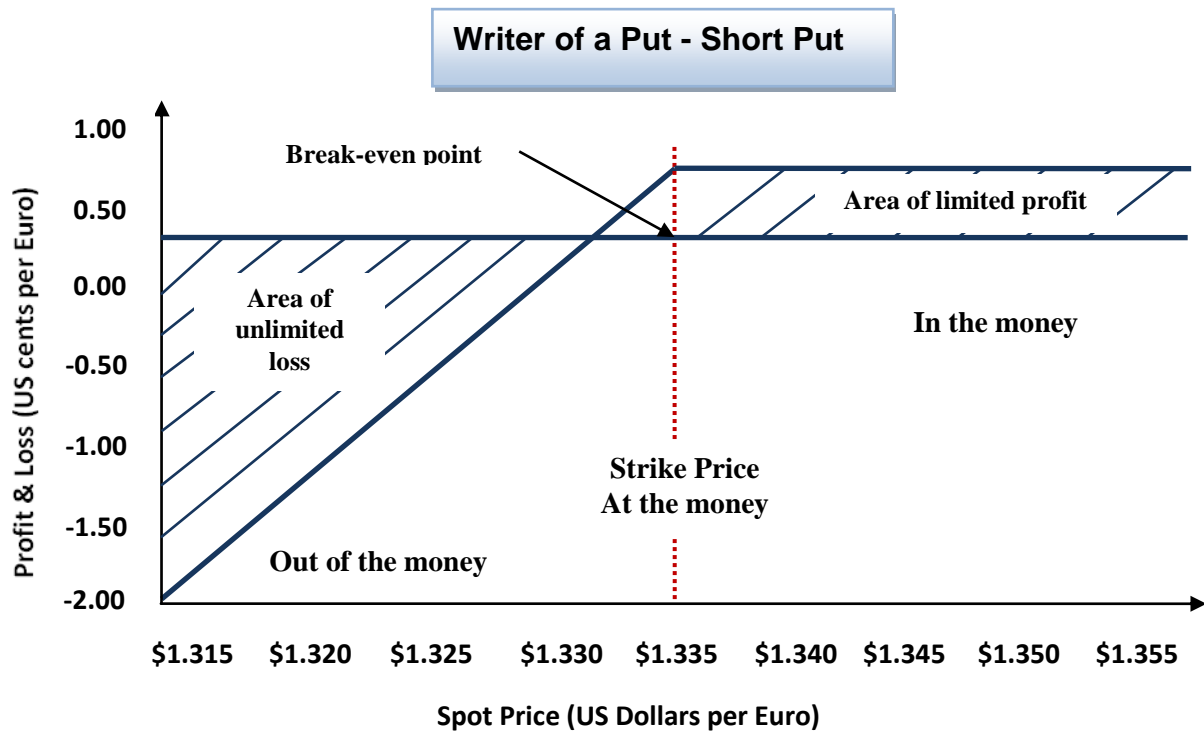

Appendix 1.8 – Option Pricing & Valuation

In general, the price of an option develops itself through economical drivers such as supply and demand. However, the price of an option is assembled through a few variables, which are influenced by various market factors.

Appendix 1.8.1 – Intrinsic Value

There are six factors that accomplish the pricing of any option. Before mentioning the six factors, there is a basic formula for calculating the total value of the option premium:



The first component of the formula, the so called **intrinsic value**, is the value of an option when it gets immediately exercised. Theoretically, an immediate exercise of an option can

only be possible, if it is an American-style option. Furthermore, an intrinsic value only exists at an ITM option. Thus, for a call option the spot price needs to be above the strike price and for a put option below. Note that the intrinsic value excludes the premium for the option.¹²³

Intrinsic value for a **call**:



And for a **put**:



When a call or put option is ATM or OTM the intrinsic value becomes negative or zero, but will always be presented as zero. Remember the example for the buyer of a call. At a strike of \$1.335 and, a spot price at \$ 1.320, the buyer has no gain from the immediate exercise of the option ($1.320 - 1.335 = -0.15$), assuming it involves an American-style option.¹²⁴

Appendix 1.8.2 – Time Value

The second and last part of the formula, in order to calculate the total value (premium) for the option, is the **time value**. The time value includes the premium of the option and builds upon the intrinsic value. For a holder of an American-style option, the immediate exercise of the option can produce a positive intrinsic value. However, excluding the premium, it is not

¹²³ M.H. Moffet, A.I. Stonehill, D.K. Eiteman, 2008, *Fundamentals of Multinational Finance*. 3rd edition. New Jersey: Prentice Hall [p. 235]

¹²⁴ C. Eck, M. Riechert, 2006, *Professionelles Eurex-Trading*. 3rd edition. München: FinanzBuch Verlag [p.59-60]

I. Uszczapowski, 2008, *Optionen und Futures verstehen – Grundlagen und neue Entwicklungen*. 6th edition. München: Deutscher Taschenbuch Verlag [p.119-121]

M.H. Moffet, A.I. Stonehill, D.K. Eiteman, 2008, *Fundamentals of Multinational Finance*. 3rd edition. New Jersey: Prentice Hall [p. 236]

<http://www.trader-soft.com/option-trading/option-basics/option-premium.html> (15-02-11)

http://www.optionseducation.org/basics/options_pricing.jsp (13-12-2010)

<http://finanzportal.wiwi.uni-saarland.de/opt/kapitel2.htm> (15-02-11)

<https://www.thinkorswim.com/tos/displayPage.tos?webpage=lessonTimeSpreads> (08-02-11)

always advantageous to exercise early. In a situation in which no intrinsic value through the immediate exercise of an option accrues, equals the time value the option premium.



The **time value** depends on the time until maturity and the volatility. An option that carries a longer lifespan costs more than an option with a lower one. Therefore, two options with the same intrinsic value, but different contract periods, carry different time values. Furthermore, an option with a high volatility yields a greater chance of being in the money at maturity.

The graph below demonstrates the correlation of the option price and the spot price of the underlying asset for a call option. The time value decays as the option gets closer to maturity. Further, with the decay of time value, diminishes the total value as well and approximates the intrinsic value.

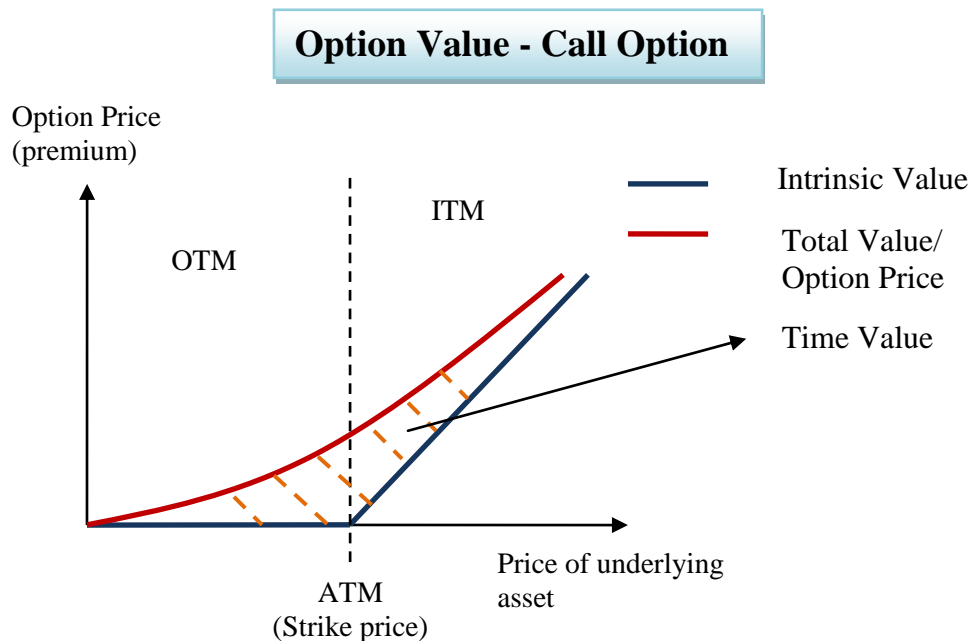

Regularly, the investor pays for an out-of-the-money option (the intrinsic value is zero) and hopes that by time to expiration the option moves into the money. Contrariwise, from the

option writer's point of view, the time value marks the amount the investor is willing to pay for the risk that the option expires in the money.¹²⁵

Appendix 1.8.3 – Cost of an option

The information about the time value and the intrinsic value might raise the question how much should an option cost? In a regular case the option should never cost more than its intrinsic value, because the purchase of the option and the immediate exercise would be cheaper than buying the stock on the market.

Additionally, the cost for an option that is ATM or OTM is simply the time value, because then the intrinsic value is zero. On the other hand, an in the money option is equal to its total value. At most, the option should not cost more than the difference between the spot and strike price.

Premiums higher than its intrinsic value leave an advantage for the writer of the option. On the other hand, a premium that costs less than its intrinsic value creates an instant profit for the owner of the option.

However, such advantages will not stay long in a fast moving market. Others will take advantage of such arbitrage opportunities in which investors can obtain a free profit. Thus, option prices will quickly drop down to a level in which no market participant is fleeced.¹²⁶

¹²⁵ I. Uszczapowski, 2008, *Optionen und Futures verstehen – Grundlagen und neue Entwicklungen*. 6th edition. München: Deutscher Taschenbuch Verlag [p.119-121]

C. Eck, M. Riechert, 2006, *Professionelles Eurex-Trading*. 3rd edition. München: FinanzBuch Verlag [p.59-60]

<http://www.trader-soft.com/option-trading/option-basics/option-premium.html> (15-02-11)

http://www.optionseducation.org/basics/options_pricing.jsp (13-12-2010)

<http://finanzportal.wiwi.uni-saarland.de/opt/kapitel2.htm> (15-02-11)

<https://www.thinkorswim.com/tos/displayPage.tos?webpage=lessonTimeSpreads> (08-02-11)

¹²⁶ M.H. Moffet, A.I. Stonehill, D.K. Eiteman, 2008, *Fundamentals of Multinational Finance*. 3rd edition. New Jersey: Prentice Hall [p. 236]

C. Eck, M. Riechert, 2006, *Professionelles Eurex-Trading*. 3rd edition. München: FinanzBuch Verlag [p.61-63]

http://www.optionseducation.org/basics/options_pricing.jsp (13-12-2010)

<http://finanzportal.wiwi.uni-saarland.de/opt/kapitel2.htm> (15-02-11)

<http://www.tradegreeks.com/articles/Article-Option-Pricing.htm> (16-02-11)

Appendix 1.9 – Arbitrage

Arbitrage opportunities describe risk-free profits, also known as a **free lunch**, through price differences such as explained above. Also, these arbitrage opportunities arise when a stock, for instance, is offered at different prices at the same time on two markets. Imagine on one market the stock is offered for 24 € and on the other one for 26 €. Quick traders will spot the difference and buy the stock for 24 € on the one market and sell it for 26 € on the other, gaining a profit of 2 €.

However, arbitrage opportunities stay merely for a few seconds because supply and demand eliminate such risk-free profits directly. Further, today's fast internet connections and trading platforms facilitate trading on exchange markets, which allows fast reactions and reduces their time of appearance.

Consequent on the example above, the stock price of 24 € will climb due to the demand, while the excess supply on the other market forces the price to decrease. Both prices will adapt to each other leaving no arbitrage opportunities behind. Thus, mistakes of mispricing can occur, but will be balanced out again by arbitrageurs.

Nevertheless, advanced computer-system (faster), almost equal information access and of course the internet prevent arbitrage opportunities from happening all too often.¹²⁷

Appendix 1.10 – Factors influencing the Option price¹²⁸

As mentioned earlier, there are six factors that influence the option premium. With regard to these six factors, only three of them will be dealt with in detail in this chapter. These there are volatility, maturity and the risk-free rate. The other three factors, price of the underlying asset, strike price and dividends are partly self-explanatory. After dividend distributions, for instance, stock prices will drop, because the company distributes part of their capital to the stockholders. As a consequence, the prices for put option will escalate. Therefore, such repercussions are appreciable.

¹²⁷ C. Eck, M. Riechert, 2006, *Professionelles Eurex-Trading*. 3rd edition. München: FinanzBuch Verlag [p.62]
<http://moneyterms.co.uk/arbitrage/> (16-02-11)

¹²⁸ C. Eck, M. Riechert, 2006, *Professionelles Eurex-Trading*. 3rd edition. München: FinanzBuch Verlag [p.63]
<http://www.theoptionsguide.com/effect-of-dividends-on-option-pricing.aspx> (16-02-11)

M.H. Moffet, A.I. Stonehill, D.K. Eiteman, 2008, *Fundamentals of Multinational Finance*. 3rd edition. New Jersey: Prentice Hall [p. 234]

Appendix 1.10.1 – Volatility

The volatility is one of the six factors, which has a certain and important influence on the option price. When trading with options, volatility can significantly affect the outcome and if underestimated, turn into a pitfall.

Standard deviations of percentage changes in the underlying asset price, describes the option volatility. In different words, option volatility describes the risk of an option, the uncertainty. A high volatility means high price fluctuations and for the owner it means a higher chance that the option could be ITM at maturity (or before; for American-style). Nonetheless, a high volatility possesses two sides; the option can run deeply into OTM too.

The option writer anticipates a higher risk of delivering (call) or accepting (put) the option, with a high or an increasing volatility due to the increased probability that the option could finish ITM. Therefore, he will request a higher premium to compensate for the risk of a loss.¹²⁹

Appendix 1.10.2 – Maturity

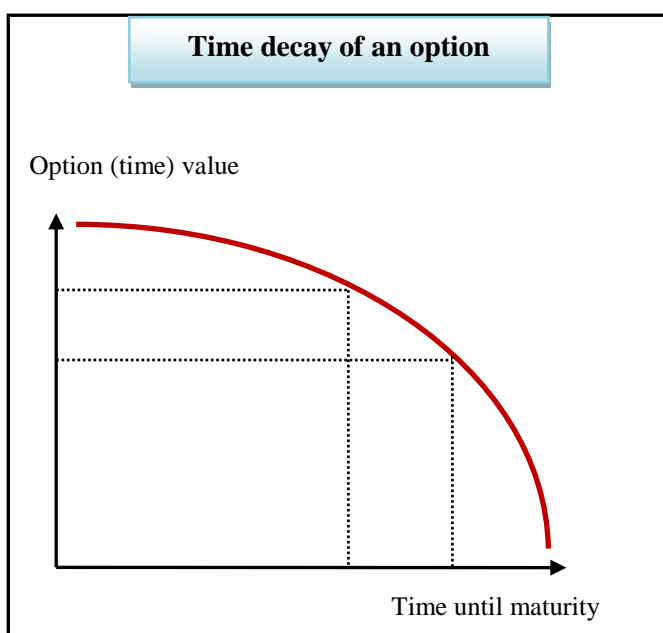

The duration of an option has a decisive influence as well. Incidentally, the maturity carries the same implications as the volatility. The longer it takes until the option matures, the more persists the chance that the option finishes in the money. Hence, the option writer will demand a higher premium selling the option.

On the other hand, the time value of an option diminishes with its maturity.

¹²⁹ M. Williams, A. Hoffman, 2000, *Fundamentals of the Options market*. New York: McGraw Hill [p. 47]
C. Eck, M. Riechert, 2006, *Professionelles Eurex-Trading*. 3rd edition. München: FinanzBuch Verlag [p.63-65]

With the approximation to maturity, decreases the premium to buy the option, because the probability of being profitable shrinks as well.

Thus, the likelihood, whether the option finishes ITM or OTM, is assessable through the time decay, which in the end impinges on the premium. More time imparts greater value.¹³⁰

Actually, the chapter about option pricing and valuation explains the adaption in option price if the price of the underlying asset or the strike price changes.

An option bought OTM has an intrinsic value of zero and its time value (then the premium) is at the lowest price (see graph again in appendix 1.9.2). Further, assume that the OTM option moves ITM, the intrinsic value increases. At the same time, the time value decayed. Hence, the option price adapts if the price of the underlying asset changes by a constant strike price. In relation to the strike price, which is fixed, the option status (ITM, ATM, and OTM, which can change due to the price of the underlying asset) determines the price of the option.¹³¹

Appendix 1.10.3 – Risk-free interest rate

As the name already implies, the risk-free rate depicts the rate or return an investor is willing to accept for a risk-free investment such as buying or selling an option. This minimum rate will not increase unless the investor accepts further risk, which may favour a higher return. In fact, a risk-free investment does not exist and so is the risk-free rate in a literal sense.

Treasury bonds and bills were considered to be a risk-free investment, because expectations for governments to default are very small. Thus, treasury securities, backed by governments, represent an important benchmark for a risk-free rate.¹³² As a result, if the investor prefers higher returns, then the risk-free rate will be higher, which ultimately has an influence on the option price. However, a high return is associated with both, a high volatility and the expiration time, thus, the risk-free rate is interacting with them.¹³³

¹³⁰ <http://www.fool.com/investing/options/2007/04/24/options-part-3.aspx> (16-02-11)

¹³¹ http://www.trading-plan.com/options_time_decay.html (17-03-11)

<http://www.meta-formula.com/commodity-options.html> (17-03-11)

C. Eck, M. Riechert, 2006, *Professionelles Eurex-Trading*. 3rd edition. München: FinanzBuch Verlag [p.65-67]

M. Williams, A. Hoffman, 2000, *Fundamentals of the Options market*. New York: McGraw Hill [p. 45]

¹³² http://www.wordiq.com/definition/Risk_free_interest_rate (16-02-11)

<http://www.bankrate.com/rates/interest-rates/treasury.aspx> (16-02-11)

¹³³ M. Williams, A. Hoffman, 2000, *Fundamentals of the Options market*. New York: McGraw Hill [p. 46-47]

C. Eck, M. Riechert, 2006, *Professionelles Eurex-Trading*. 3rd edition. München: FinanzBuch Verlag [p.67-70]

Appendix 1.11 – Black-Scholes Model

The Black-Scholes-Model (BS Model), is one of the most widespread and accredited financial mathematical models in the world to evaluate options, especially European-style options that pay no dividends. It was created 1973 by Fischer Black and Myron Samuel Scholes. In the early years, no model existed to evaluate an option and uncertainty was a big objector. Nowadays, this model became a standard reference model to find out the fair value of an option. The Black-Scholes-Model requires a few inputs¹³⁴:

- Risk-free rate
- Volatility
- Price of the underlying security
- Strike price
- Time until maturity
- Premium

The model and its formulas are very complicated as the formulas below demonstrate and require a calculation of the risk-free rate, if it is not continuously compounded, and of the volatility before.¹³⁵

$$\text{Price(Call)} = S \times N(d1) - K \times e^{-rf \times T} \times N(d2)$$

$$\begin{aligned} \text{Price(Put)} &= K \times e^{-rf \times T} \times N((d2) - 1) - S \times N((d1) - 1) \\ &= K \times e^{-rf \times T} \times N(-d2) - S \times N(-d1) \end{aligned}$$

$$d1 = \frac{\ln\left(\frac{S}{K}\right) + \left(rf + \frac{\sigma^2}{2}\right) \times T}{\sigma\sqrt{T}} + \frac{\sigma\sqrt{T}}{2}$$

$$d2 = \frac{\ln\left(\frac{S}{K}\right) + \left(rf - \frac{\sigma^2}{2}\right) \times T}{\sigma\sqrt{T}} = d1 - \sigma\sqrt{T}$$

$$d2 = d1 - \sigma\sqrt{T}^{136}$$

¹³⁴<http://www.articlesnatch.com/Article/What-Is-Black-Scholes-Model-Option-Pricing-/908474> (14-02-11)

M. Williams, A. Hoffman, 2000, *Fundamentals of the Options market*. New York: McGraw Hill [p.43+310]

J.C. Hull, 2008, *Fundamentals of Futures and Option Markets*. 6th edition. New Jersey: Prentice Hall [p.269]

¹³⁵ <http://hilltop.bradley.edu/~arr/bsm/pg04.html> (16-02-11)

C. Eck, M. Riechert, 2006, *Professionelles Eurex-Trading*, 3rd edition: Druckerei Joh. Walch, Augsburg [p.81-82]

In which,

- P_{Call}** = Price/Premium of the Call option
K = Option Exercise Price
S = Current Spot rate /Spot price
e = Euler's constant
rf = Annual continuously compound risk-free interest rate
T = time until maturity in years
σ = annual volatility for the underlying stock
N(d₁) = Cumulative Normal distribution of (d₁)
N(d₂) = Cumulative Normal distribution of (d₂)
Ln = Natural Logarithm

Appendix 1.11.2 – Volatility

The option volatility may not be given always. Since the BS-Model requires volatility, it needs to be forecasted. The two main methods to calculate the volatility are the historic and the implied one.

The historic volatility rather reckons itself based on past values, while the implied volatility looks at present values to predict the future volatility.

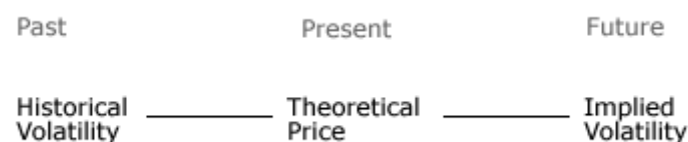

137

Nonetheless, one should bear in mind when evaluating the BS-Model that the volatilities are based on subjectivity, because all forms of volatility demand some sort of prediction.

Appendix 1.11.2.1 – Historic Volatility

¹³⁶ J.C. Hull, 2008, *Fundamentals of Futures and Option Markets*. 6th edition. New Jersey: Prentice Hall [p.279 – 281]

D.J.Higham, 2004, *An Introduction to Financial Option Valuation*. 1st edition. Cambridge: Cambridge University Press [80-81]

<http://www.quickmba.com/finance/black-scholes/> (15-12-2010)

<http://www.hoadley.net/options/BS.htm> (18-02-11)

http://www.optiontradingpedia.com/free_black_scholes_model.htm (16-12-10)

<http://www.ltnielsen.com/wp-content/uploads/Understanding.pdf> (18-12-10)

<http://www.wiwi.uni-frankfurt.de/~doerner/kap3.pdf> (18-12-10)

¹³⁷ <http://www.optiontradingtips.com/options101/volatility.html> (17-12-10)

One possibility to forecast the volatility of an option is via the historic volatility. It predicts the volatility of tomorrow through the percentages changes in the standard deviation of the underlying security as prescribed above.

Firstly, the historic volatility can be calculated through a time-series analysis on past spot-rate movements on a daily, weekly, monthly, or yearly base (depends on the observers preferences). A daily movement analysis can reveal a rather precise ascertainment for volatility than weekly or monthly dates. However, sometimes such analysis includes shocks and amplitudes through missing data, influencing events that occurred, and others, which can distort the computed volatility. Thus, volatilities need to be used with prudence otherwise they can misdirect or be misinterpreted.¹³⁸

Appendix 1.11.2.2 – Implied Volatility

A second alternative method to forecast the volatility of an option is the implied volatility. It is calculated via the recent observed prices of an option on the market. Given all the other factors of an option such as, spot price, strike price, time until maturity and the risk-free interest rate, the implied volatility can be traced out of it.

The implied volatility can be determined by calculating the BS-model. The volatility will be set as the unknown factor that needs to be calculated and the formulas can be solved for the unknown volatility. A precondition is that all other data is given.

Nevertheless, factors such as the exercise price, the risk-free rate, maturity date and the price of the option have an impact on the implied volatility, because if one of them changes, changes the implied volatility as well. Of course, when working with such theoretical models, one does not want to miscalculate volatility since it has a tremendous influence on options and traders want to avoid any negative surprises.¹³⁹

Appendix 1.12 – Binomial Model

¹³⁸ C. Eck, M. Riechert, 2006, *Professionelles Eurex-Trading*. 3rd edition. München: FinanzBuch Verlag [p. 66]

¹³⁸ M. Williams, A. Hoffman, 2000, *Fundamentals of the Options market*. New York: McGraw Hill [p.56-58]

J.C. Hull, 2008, *Fundamentals of Futures and Option Markets*. 6th edition. New Jersey: Prentice Hall [p.274 – 277]

¹³⁹ D.J. Higham, 2004, *An Introduction to Financial Option Valuation*. Cambridge: Cambridge University Press [p.131]

M. Williams, A. Hoffman, 2000, *Fundamentals of the Options market*. New York: McGraw Hill [p.57-59]

http://www.power4xl.com/black_scholes/functions/implied_volatility.html (20-12-10)

Besides the Black-Scholes model concludes another model the fair value for an option. However, the binomial model steps in where the BS model fails. The binomial model can determine the price for an American-style option, because the model breaks down all the time intervals until maturity, which permits to resolve accurately the fair price at each time interval. Nevertheless, the model is time-consuming and cumbersome.

Additionally, the binomial model builds partly upon the Black Scholes model. The ingredients for the binomial model are almost equal to the BS model.

Furthermore, the binomial model works as a tree with knots. At each node there are two possibilities, the up and the down state. The stock price can either move up or down. Both states will a probability be assigned.

Additionally, depending on the time intervals until maturity (infinite or finite) a continuous or discrete probability needs to be calculated.

For the binomial method, one computes tree backwards, starting by the last node and finishing by the first one at time zero. However, at first a stock tree will be created with help of the up and down state, to compute the possible future outcomes at each node. Based on the stock tree the call or put can be calculated through the so called “backwards induction”, the futures values of the stock trees will be discounted to the present value (fair value) at time zero.

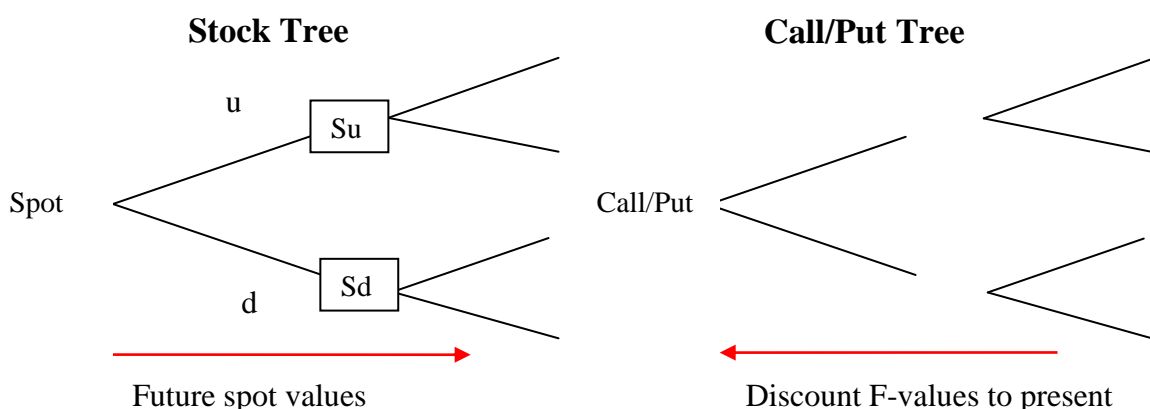

140

¹⁴⁰ <http://www.hoadley.net/options/BS.htm> (19-02-11)

<http://www.stat.wmich.edu/s160/book/node33.html> (19-02-11)

http://www.stats.gla.ac.uk/steps/glossary/probability_distributions.html#discvar (19-02-11)

D.J.Higham, 2004, *An Introduction to Financial Option Valuation*. Cambridge: Cambridge University Press [p.151-154]

Appendix 1.13 – Option Strategies

Option strategies open various possibilities of using single or combined positions in order to gain a profit from the market movements, different than the usual buying or selling of stocks on the market.

Further, the strategies offer a higher profit potential, open the opportunities to be used for hedging and permit to limit losses. The strategies vary from simple to complex, depending on which positions are taken and what the purpose of the strategy is.

Some are constructed simply out of call options, while others are constructed of put options. Due to the four basic positions introduced earlier, various combinations can be driven. Moreover, they vary in its purpose as well. These purposes range from expectation of the underlying asset price, to risk level, volatility, rentability and flexibility.¹⁴¹

Appendix 1.13.1 – Commissions/Transaction costs

Naturally, some brokers or brokerage houses that initiate the orders or set up the trade require a commission for their work. Also, depending on the exchange and the currency, the trades can involves transaction costs that occur due to the transfers and conversion. These amounts can be from significance when entering an option trade, because sometimes they can be cumbersome to gain a profit or increase a loss. Nevertheless, for the explanation of the hedging strategies in the following chapters were no transaction costs considered in order to simplify the calculations.

Appendix 1.13.2 – Hedging Strategies

The hedging strategies allow, as the name hedging already induces, to protect against certain market development of a stock. Additionally, the hedging strategies imply a long or short stock position of an underlying asset as well as a position in an options contract. In this chapter various strategies will be demonstrated. These strategies are implemented in different

J.C. Hull, 2008, *Fundamentals of Futures and Option Markets*. 6th edition. New Jersey: Prentice Hall [p.357-361]

¹⁴¹ http://www.optiontradingpedia.com/free_option_strategies.htm (08-02-11)

http://www.optionseducation.org/resources/literature/files/options_strategies_quick_guide.pdf (08-02-11)

situations and each follows a different purpose. At first, the simple ones will be introduced before getting to the more complex ones.

Appendix 1.14 – Simple Hedging Strategies

Simple hedging strategies engage merely one option position. A little table will provide an overview with the key aspects for each simple hedging strategy. However, here, a protective call and a writing covered put are presented to communicate a first impression.¹⁴²

Hedging strategy	Type of exposure	Expected volatility	Hedging positions
Protective Put	Long Stock	High	Long Put
Writing Covered Call	Long Stock	Small	Short Call
Protective Call	Short Stock	High	Long Call
Writing Covered Put	Short Stock	Small	Short Put

Appendix 1.14.1 – Protective Call

The concept for a **protective call** is almost the same as for a protective put. Firstly, an investor might have borrowed some stocks from a broker and is about to sell them in the market. The investor takes a short stock position. Assuming the investor sold the stock, at some point he has to return the borrowed stocks to the broker. Thus, if the stock is falling in price they can be bought at a cheaper price on the market, leaving him with the difference as a profit.

On the other side, the investor is uncertain about a soaring stock price. As a consequence he might need to liquidate the position and buy the stocks back at nearest price to limit losses. However, he has to give up the access to future profits, if the stock starts to fall. In order to prevent such an occurrence the purchase of a call option ATM can protect and limit the loss without risking the access to future profits. The protective call consists of the following parts:

¹⁴² http://www.optiontradingpedia.com/free_covered_call.htm (08-02-11)

Protective Call					
Activity	Position	Type	Strike	Amount	Maturity
Sell	Short	-	-	1	equal
Buy	Long	Call	ATM	1	equal

Likewise, the theory for a protective call is the same as for the protective put. The maximum profit is unlimited. Nonetheless, the potential profit is to be seen with a decrease in stock price rather than an increase as in a protective put, which the graph below illustrates.

Generally speaking, the maximum profit as well as the maximum loss is determined the same way as in a protective put, merely with the opposite direction. Thereupon, the protective call can be calculated by the subsequent formulas:

- **Protective Call** = Short Stock + Long Call
- **Short Stock** = Prior sold stock – Current stock price
- **Long Call** = Stock price – (Strike price + Premium)
 - At maturity of the option, assuming european – style
- **Maximum Profit** = Unlimited
- **Maximum Loss** Premium Paid
- **Break – even** = Stock price(sold) + Premium

The graph below shows how the positions of a protective call correlate:

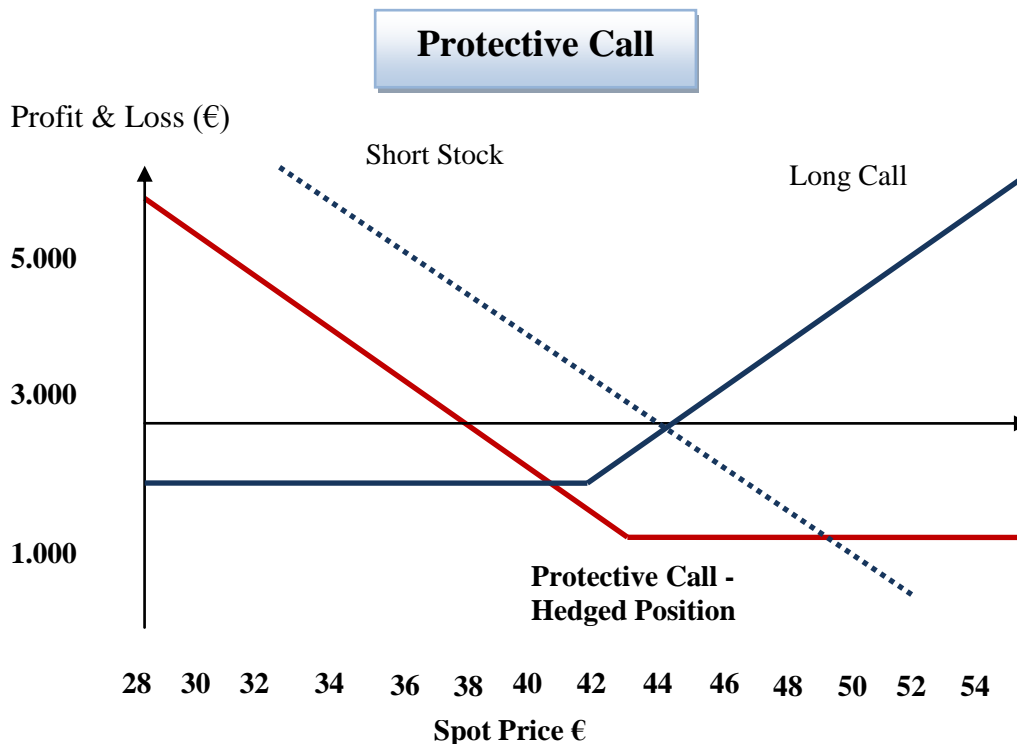

The long call, used to protect against raising prices transforms the unhedged short stock position into a hedged position, former known as a put. A little figure will demonstrate an example for a best case scenario for a protective call:

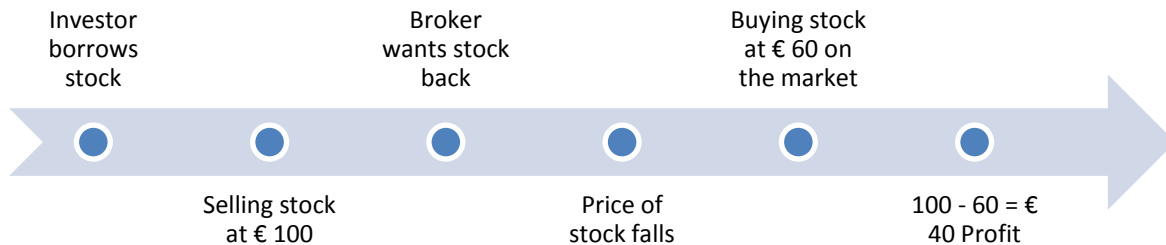

143

Appendix 1.14.2 – Writing Covered Put

The title of the strategy partly introduces the elements of a covered put. Comparatively, the covered put protects a short stock position as in a protective call, but employs a short put position instead of a long call. Recall that the seller of a call or a put option is also referred to as the writer of an option and always takes the short position. The writing-a-covered-put strategy, also recognised as the “**naked put**”¹⁴⁴, involves a certain risk.

The investor assumes in the short stock position that the stock price is going to decline. In the hope that the price will decline further he will write a put option and sell additional stocks against the short position. Regardless of an abrupt fall in price, the short stock will be on the beneficial side as well, which shall cover the losses of the put option.

Nonetheless, the main idea behind the covered put is to generate an income by the premium of the put options. In short, writing a covered put includes:

Writing a Covered Put					
Activity	Position	Type	Strike	Amount	Maturity
Sell	Short	-	-	1	equal
Sell	Short	Put	ATM	1	equal

¹⁴³http://www.schwab.com/public/schwab/research_strategies/market_insight/investing_strategies/options/protective_puts_and_protective_calls.html (02-02-11)

C. Eck, M. Riechert, 2006, *Professionelles Eurex-Trading*. 3rd edition. München: FinanzBuch Verlag [p.120-121]

http://www.optiontradingpedia.com/protective_call.htm (22-12-2010)

<http://www.theoptionsguide.com/protective-call.aspx> (02-02-11)

¹⁴⁴<http://www.get122.com/covered-put-options.htm> (02-02-11)

In addition to that, the maximum profit of a covered put is limited, whereas the loss is unlimited. Even though a declining stock price sounds favourable for the investor, it will spoil the profit of the short position due to the short put.

On the other hand, if the spot price will grow above the strike price of the put, the option holder will not exercise the put option and the writer of the covered put can pocket the premium for himself. Nevertheless, the short stock has lost in value, which leaves the premium as the only plus.

- **Writing Covered Put** = Short Stock + Short Put
- **Short Stock** = Prior sold stock – Current stock price
- **Short Put** = Premium – (Strike Price – Stock Price)
 - At maturity of the option, assuming european – style
- **Maximum Profit** = Premium
- **Maximum Loss** = Unlimited
- **Break – even** = Strike Price Put – Premium

As an illustration for the different positions in covered put serves the graph beneath:

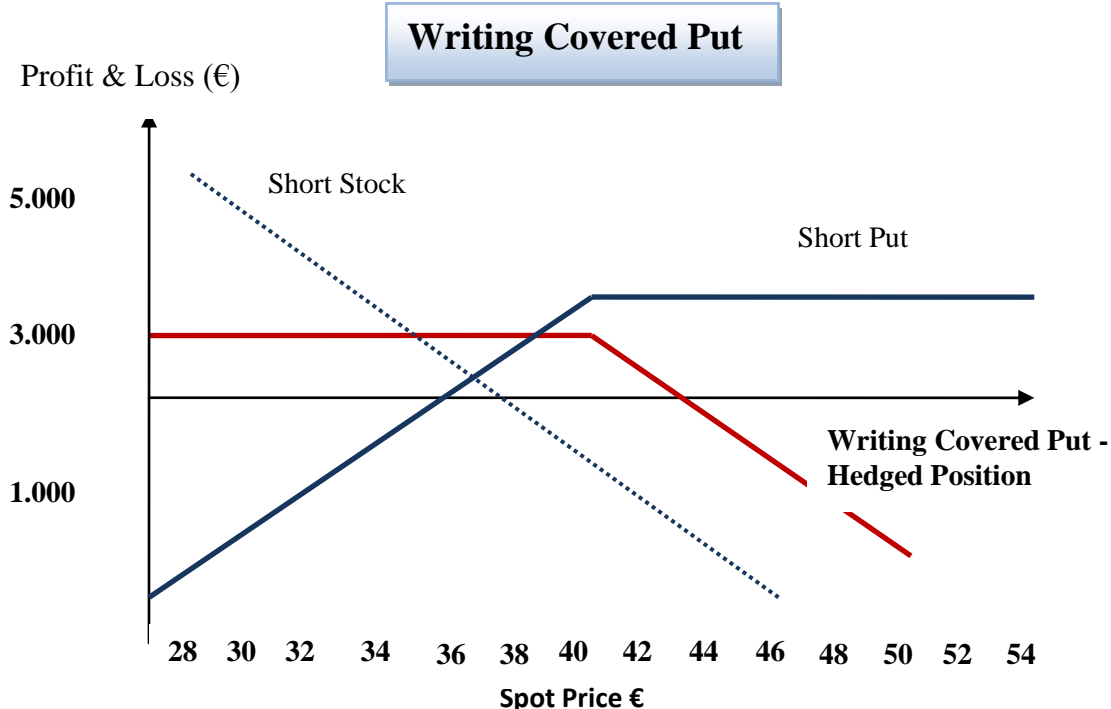

¹⁴⁵ C. Eck, M. Riechert, 2006, *Professionelles Eurex-Trading*. 3rd edition. München: FinanzBuch Verlag [p.121-122]

http://www.optiontradingpedia.com/free_covered_put.htm (03-02-11)

<http://www.callwriter.com/newsletter/covered-puts.htm> (02-02-11)

Appendix 1.15 – Complex Hedging Strategies

The more complex or advanced option strategies involve more than one position. Further, these strategies are applied for different expectation about the price or volatility of the underlying asset. Moreover, the categorisation about option strategies disperses in terms of their market movement, expectations or spreads, but also of their importance and cognition/acknowledgement.

However, in this section the strategies will be divided in four main categories, which are **bullish**, **bearish**, **volatility** and **neutral**. The bullish and bearish strategies centre mainly increasing and decreasing price expectations as the names already indicate. Additionally, the volatility strategies focus on different volatility expectations. Neutral strategies close are to be applied in situations of uncertainty about price or volatility expectations.

Despite the numerous different option strategies, only a one or two examples will be outlined in this section to give an example and overview about the diversity and capability of option strategies.¹⁴⁶

Appendix 1.15.1 – Bullish Strategies

Appendix 1.15.1.1 – Bull Call Spread

The **bull call spread**, emphasise the expectation of an increase in price. The key point of the bullish spread is that it merely consists of call options. The strategy bets on an increase in price of the underlying asset in the near future. It implies to receive a profit via the spread of the long and the short call.

Bull Call Spread					
Activity	Position	Type	Strike	Amount	Maturity
Buy	Long	Call	ATM	1	equal
Sell	Short	Call	OTM	1	equal

<http://www.get122.com/covered-put-options.htm> (02-02-11)

http://www.tradingmarkets.com/site/options/how_to/articles/-75478.cfm (02-02-11)

¹⁴⁶ <https://www.thinkorswim.com/tos/displayPage.tos?webpage=lessonTimeSpreads> (08-02-11)

I. Uszczapowski, 2008, *Optionen und Futures verstehen – Grundlagen und neue Entwicklungen*. 6th edition. München: Deutscher Taschenbuch Verlag [p. 169]

Example Bull Call Spread:

Consider, for example, a purchase of a long call option at € 240 spot price ATM and the sale of a short call option at a € 260 OTM spot price. Since, it is assumed that the spot price is going to increase, the long call option costs € 20 (premium) and the short call option € 7, because the higher the exercise price, the lower the costs for the option (*ceteris paribus*). At maturity spot price is € 270. Now, the investor of the call bullish spread strategy can exercise his call option for € 240 and sell them on the market for € 270. However, his short call option will be exercised of the buyer at the strike of € 260 and sold at € 270 as well. Finally, it needs to be calculated what is left over after the execution and if it is enough the cover the spread of the premium (20 – 7):

Long Call:	$270 - 240 = 30$	}	Profit: $30 - 10 - 13 = + € 7$
Short Call:	$260 - 270 = -10$		
Premium:	$7 - 20 = - 13$		

In such a strategy the sale of the option (short call) can be used to subsidise the costs of the purchase for the long call option. Generally, the call is sold at a higher strike price.

As it can be seen in the graph below, both calls together limit the maximum profit as well as the maximum loss. Notably, the outcome is similar as in the protective and covered strategies. If at maturity both calls end up OTM, no one will exercise the options. Further, the costs for the holder of the strategy will be the net difference in the premiums (7 - 20 = - €13), which are the initial costs of the strategy. When the initial result of the premiums is negative, which occurs when the price of the purchased option is higher than the one sold, one is talking about a **debit spread**.

On the other hand, if the spot price should exceed the strike of the short call, both will exercise their options. Although the premium may not be enough to cover the losses, the long call option will denote a sufficient gain in value too. Yet, as in the example above, the investor can leave with a slight profit. One can pose the question: what is the best exercise price to purchase and to sell a call option? Hence, for an optimum it is necessary to meet the right strike price. A higher difference in the exercise prices could increase the profit a little

more. However, it enhances the net costs of the premium and if only the long call runs ITM, the profit will not be sufficient to outweigh the costs of the premium.¹⁴⁷

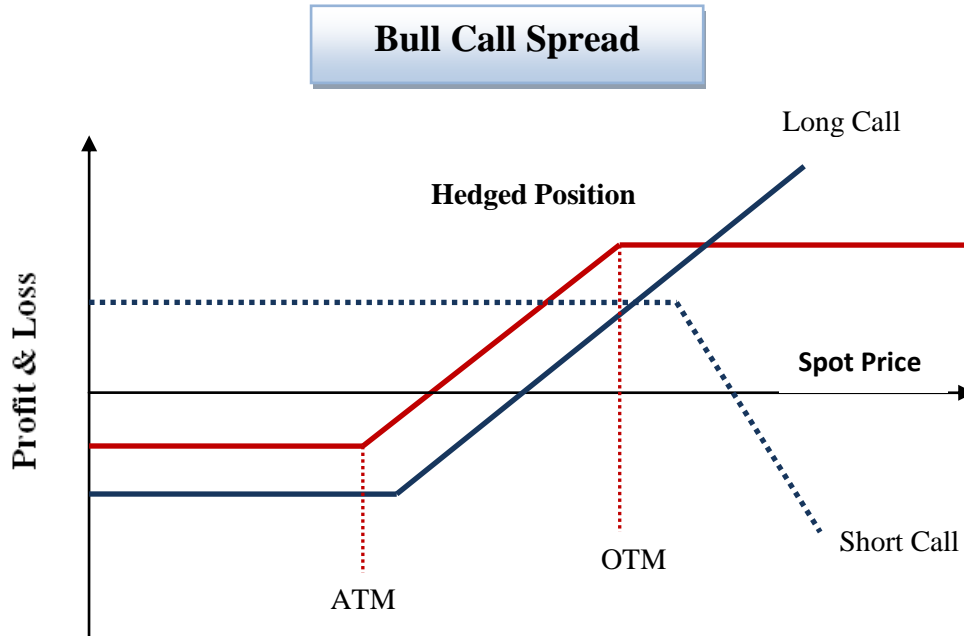

Appendix 1.15.1.2 – Ratio Call Spread

A rather complex bullish strategy puts together the ratio call spread. Based on a bull call spread strategy, adds the ratio call another short position. Thus, one call will be bought ATM and two calls will be sold with an OTM strike price. The additional call sold, reinforces the purchase for the call option. Regularly, the second call sold is not enough to cover the costs for the purchase, which makes it a debit spread. Nonetheless, depending on the prices of the premiums, it can be a credit spread.

Ratio Call Spread					
Activity	Position	Type	Strike	Amount	Maturity
Buy	Long	Call	ATM	1	equal
Sell	Short	Call	OTM	2	equal

¹⁴⁷ C. Eck, M. Riechert, 2006, *Professionelles Eurex-Trading*. 3rd edition. München: FinanzBuch Verlag [p.145-150]

http://www.optionseducation.org/strategy/bull_call_spread.jsp (09-02-11)

<http://www.theoptionsguide.com/bull-call-spread.aspx> (09-02-11)

http://www.optiontradingpedia.com/free_bull_call_spread.htm (09-02-11)

The ratio call spread strategy is actually a combination of a bearish call and a short strangle, which will be explained later. The investor hopes that the spot price will not increase a lot in the nearby future, but enough to reach the peak of the ratio call spread strategy for a maximum profit. Then, only the ATM put will be in-the-money, enough to cover the debit spread. Yet, the OTM put options will not be in the money.

However, on the downside, if the spot price should exceed the OTM spot price of the sold call, the risk can get unlimited for the writer of the options. The options will be in-the-money can outweigh the purchased put lass the net debit of premiums. Furthermore, if the price decreases below the purchased ATM call, both options will expire of no value and the loss will be limited to the net debit of the premiums. Nonetheless, key point of the strategy is the difference of the strike prices. Depending on the differences, it will conceivable whether it is a debit or a credit spread, which ultimately decides about the profit potential.¹⁴⁸

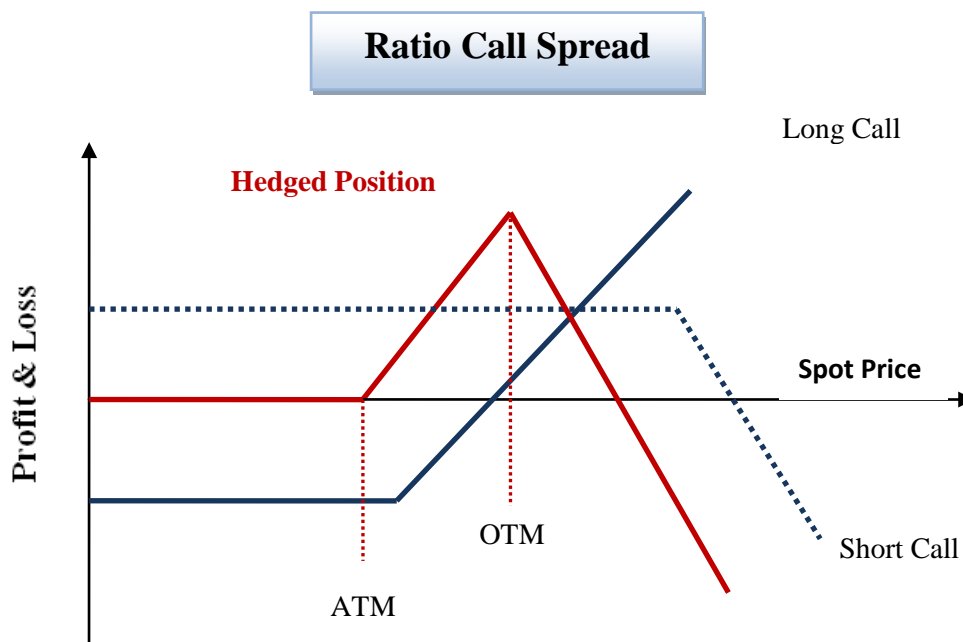

¹⁴⁸ <http://www.theoptionguide.com/ratio-spread.aspx> (09-02-11)

C. Eck, M. Riechert, 2006, *Professionelles Eurex-Trading*. 3rd edition. München: FinanzBuch Verlag [p.150-154]

http://www.baresearch.com/education/options/advanced_strategies/vertical/ratio_call.php (09-02-11)

http://www.optiontradingpedia.com/call_ratio_spread.htm (09-02-11)

Appendix 1.15.2 – Bearish Strategies

Appendix 1.15.2.1 – Bear Put Spread

Different from the bull call spread, focuses the bear put spread on a decrease in the spot price. Also, the put bearish spread is composed of put options. Once again, the strategy benefits from the spread between the long and the short put. The premium of the short put position is used to finance the purchase of the long put. Hereby, the bear put is a debit spread as well, because premium for the purchase of the long put is higher than the short put due to the difference in strike prices.

Bear Put Spread					
Activity	Position	Type	Strike	Amount	Maturity
Buy	Long	Put	ATM	1	equal
Sell	Short	Put	OTM	1	equal

Example Put Bearish Spread:

The strike price for the bear put spread strategy as well as for the bull call has not to be necessarily ATM. Sometimes the option will be purchased at a strike price that is lower than the current market price, placing the option ITM. This gives a little guarantee and chance of gaining a higher profit out of the long position.

As a result, the costs for an option that is already ITM is much higher than an option ATM or OTM. The seller of such an option wants to compensate for the profit that is given away. Now, an investor purchases a put option at a price of € 90 with the costs of € 5. The current market price stands at € 89. Additionally, he sells a put option for € 75 and in contrast receiving a premium at € 1.

At maturity, the market price is at € 70 and both options are in the money. Both can sell the option at a higher price and re-purchase them on the market at a cheaper price profiting from the difference.

Long Put: $90 - 70 = 20$

Short Put: $70 - 75 = -5$

Premium: $1 - 5 = -4$

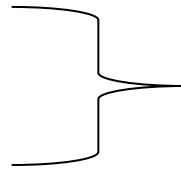

Profit:
 $20 - 5 - 4 = + € 11$

Thus, the intrinsic value of the long put gains a profit of € 20, while the short put loses in value by € 5. Together with the loss of the premium the investor gains a profit of € 11.

The illustration of the bear put spread is quite similar to the bull call spread. The maximum profit and loss is limited. If the spot price at maturity is above the strike prices of the put options (OTM), the maximum loss for the investor will be the net difference of the premiums.

Identically with the bull call spread is the strike price the main criteria of the strategy. Depending on, at which strike price the put was purchased and at which the other put was sold decides about the maximum profit and loss. Additionally, whether one put or both puts come in the money determines the level of profit and loss.¹⁴⁹

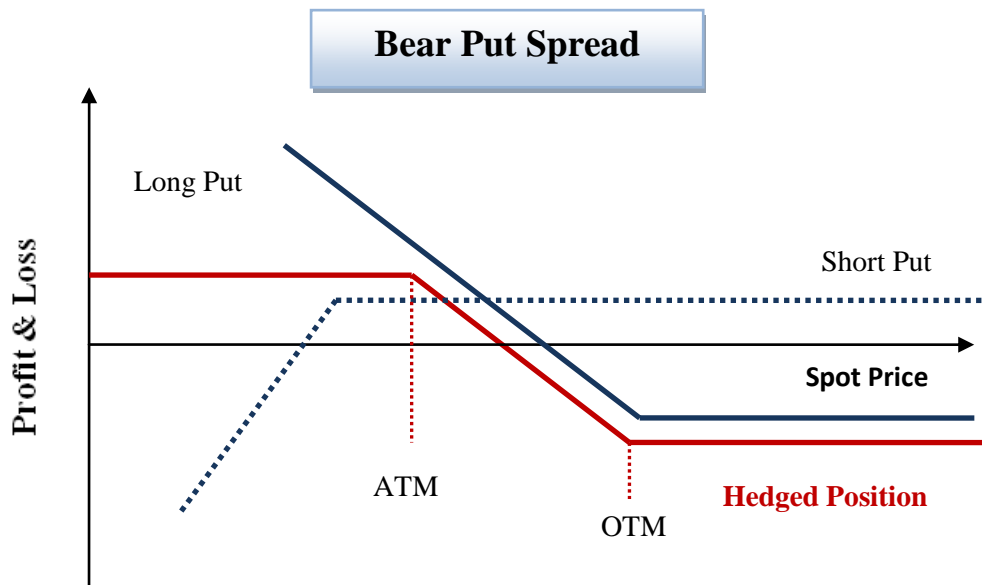

¹⁴⁹ C. Eck, M. Riechert, 2006, *Professionelles Eurex-Trading*. 3rd edition. München: FinanzBuch Verlag [p.155-158]

http://www.optionseducation.org/strategy/bear_put_spread.jsp (09-02-11)

http://www.callsandputs.com/desc_BearPut.asp (09-02-11)

Appendix 1.15.3 – Volatility strategies

Appendix 1.15.3.1 – Long Straddle

An option strategy, which benefits from a high volatility and whereat it is not certain if the spot price of the underlying asset is going to increase or decrease, fulfils the long straddle.

Moreover, a long straddle consists of the purchase of a call and a put option at the same time, with the same strike price and time until maturity. Due to the combination of a put and a call option, there will be always a profitable side, whether the price rises or falls.

Long Straddle					
Activity	Position	Type	Strike	Amount	Maturity
Buy	Long	Call	ATM	1	equal
Buy	Long	Put	ATM	1	equal

Regularly, both options will be bought ATM. This guarantees that immediately, one of the options runs into money. If for some reason ATM options cannot be bought, the next closest exercise price will do as well. Further, the maximum profit for this strategy is unlimited.

On the other hand, the maximum loss is limited to the sum of the premiums paid for both options, which is the downside peak of the “V” of the long straddle. Also, with help of the strike price and the premiums of the options, the upper and lower break-even-points can be determined.

For example, a long call and a long put option at an ATM spot price of € 100 cost € 16 and € 12. Thus, the long call position gets profitable as soon as the spot price passes € 128 (100 + (16 + 12)) and the long put gets profitable when the spot price falls below € 72 (100 – (16 + 12)). Additionally, in the event of that the spot price of the underlying asset will be at € 100 at maturity, the maximum loss will be € 28, the sum of the premiums. Therefore, with pre-assumptions about strong volatilities, but uncertainty about the direction of the spot price, is the long straddle a cheap and reasonable strategy to be placed in such a situation.¹⁵⁰

¹⁵⁰ C. Eck, M. Riechert, 2006, *Professionelles Eurex-Trading*. 3rd edition. München: FinanzBuch Verlag [p.128-133]

http://www.optionseducation.org/strategy/long_straddle.jsp (11-02-11)

<http://www.theoptionsguide.com/long-straddle.aspx> (11-02-11)

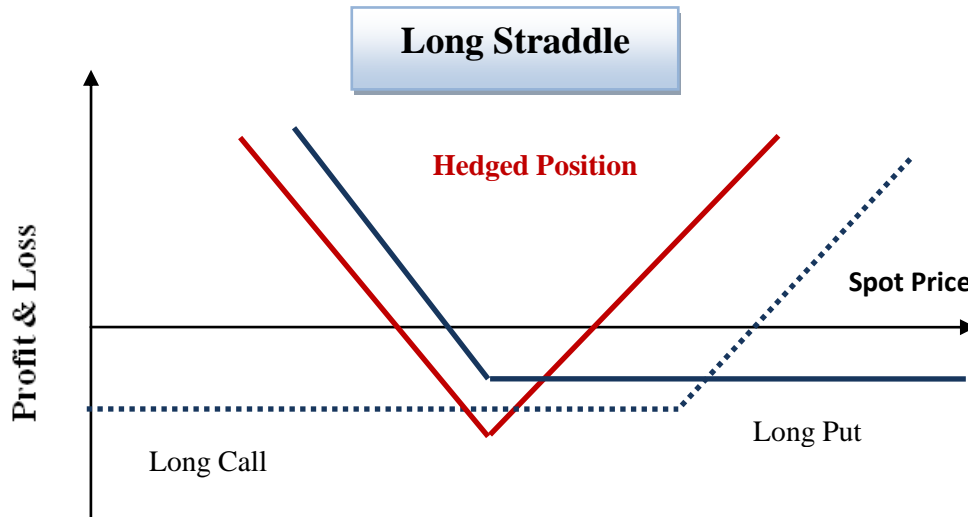

Appendix 1.15.3.1 - Long Strangle

Similar to the long straddle, centralizes the long strangle the purchase of a put and call option as well. However, the long strangle rectifies the high costs in a long straddle by purchasing options with strike prices OTM and not ATM, but with the same contract period and of the same underlying security. Further, the long strangle strategy implies a high volatility of the underlying asset price.

Long Strangle					
Activity	Position	Type	Strike	Amount	Maturity
Buy	Long	Call	OTM	1	equal
Buy	Long	Put	OTM	1	equal

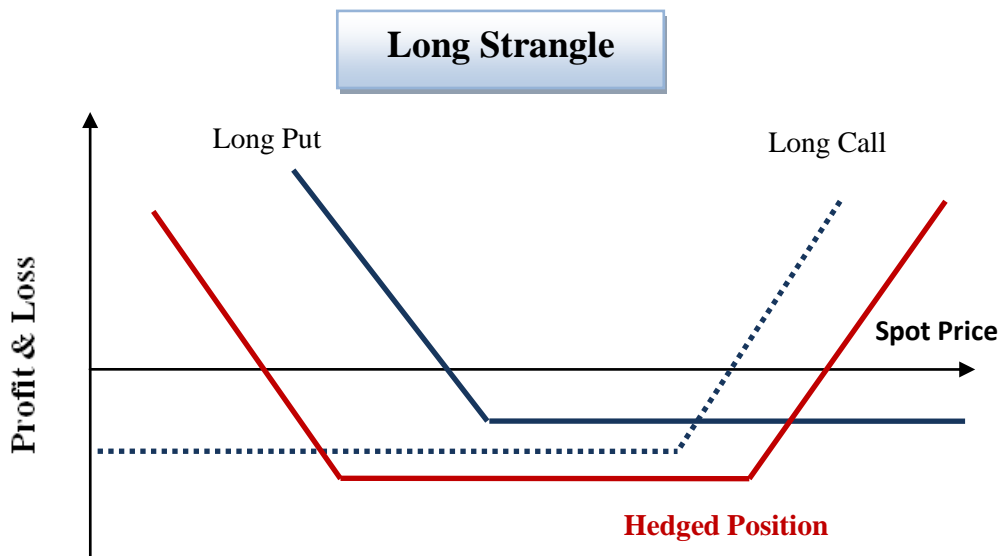

Again, the maximum loss of the long strangle forms the premium paid for the purchase of the two options. Different than in a long straddle, the maximum loss is lower due to the options bought at strike prices OTM and not ATM. Nonetheless, the range for the maximum loss has a longer period and is not centred in a peak as in the long straddle.

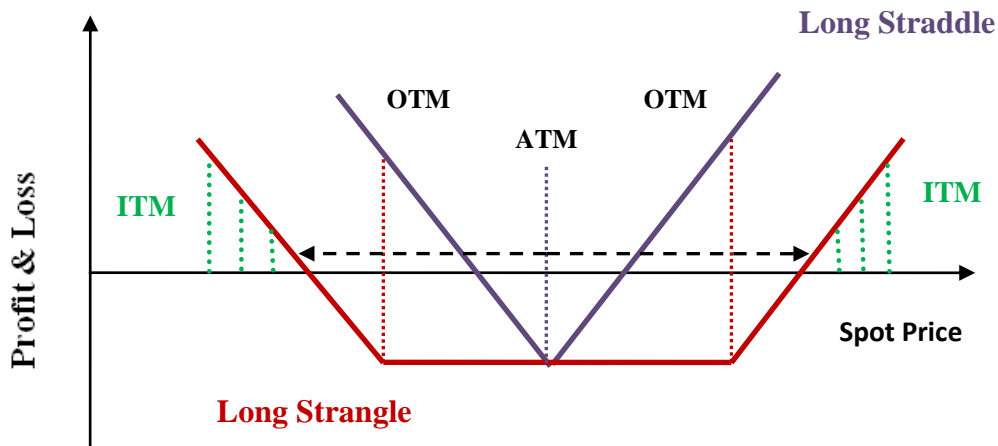

Thus, with the strike prices OTM, the break-even points of the long strangle move automatically further outwards. Also, the spot price has to rise or drop by a considerable amount to exceed one of the OTM prices as well as either the upper or lower break-even point to run ITM and realize a profit. After passing one of these marks the profit for the long strangle can become unlimited as the endings of the bowl display. Summarized, the long strangle belongs to a neutral strategy, since it does not concern in which direction the market price runs as long as one of the break-even points gets crossed. Finally, the risk of the long strangle is known, which is equal to the maximum loss (option premiums).¹⁵¹

Appendix 1.15.4 – Neutral Strategies

Appendix 1.15.4.1 – Long Butterfly Spread

The long butterfly strategy belongs to the neutral strategies. It is entered when expectations about the price movements and the volatility are very low. Further, it is entered when there is uncertainty about direction in which the price will move.

¹⁵¹ C. Eck, M. Riechert, 2006, *Professionelles Eurex-Trading*. 3rd edition. München: FinanzBuch Verlag [p.133-134]

<http://www.poweropt.com/longstranglehelp.asp> (11-02-11)

http://www.optionseducation.org/strategy/long_strangle.jsp (11-02-11)

The long butterfly spread can consist of call or put options. Four option positions form the long butterfly. As an example, for a long call butterfly, two call option with strikes prices ATM will be sold and two call options purchased, one with a ITM strike price and one with an OTM price.

Long Call Butterfly					
Activity	Position	Type	Strike	Amount	Maturity
Buy	Long	Call	OTM	1	equal
Sell	Short	Call	ATM	2	equal
Buy	Long	Call	ITM	1	equal

As well as for some other strategies, the long butterfly spread is a debit spread. The sale of the two calls is used to finance the positions for the purchase. The maximum profit part forms the line between the ITM long call and the ATM short call options.

Similar to the other option strategy examples, the maximum profit will be, if the price of the underlying asset is close or at the ATM price of the short calls at maturity. The ITM purchased call will be at the maximum value and the other options will be worthless to exercise. Of course, the net debit of the premiums needs to be included in the end as well.

In addition to that, a favourable part of the strategy is that the maximum loss is limited to both sides, whether the price rises or falls. If the price of the underlying asset should fall below the ITM, no one will exercise the options and the loss will be the net debit of the premiums. On the other hand, if the price should exceed the call with the OTM strike price, then the long positions can equal out the short positions, which leaves again the net debit of the premiums.

Important for this strategy is that the purchased call options at ITM and at OTM are combined as much as the two sold calls. Otherwise, the maximum loss will not be the net debit. However, strike prices that are not balanced will increase the risk and the strategy would not be neutral anymore. Certainly, if one side preponderates, it will be rather a bullish or bearish strategy.¹⁵²

¹⁵² <http://www.theoptionguide.com/butterfly-spread.aspx> (12-02-11)

http://www.optiontradingpedia.com/free_butterfly_spread.htm (12-02-11)

C. Eck, M. Riechert, 2006, *Professionelles Eurex-Trading*. 3rd edition. München: FinanzBuch Verlag [p.181-185]

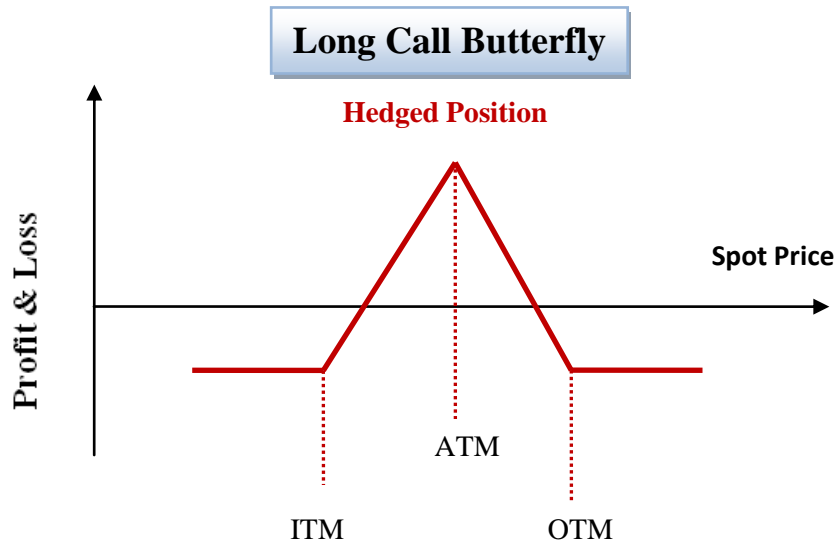

Appendix 1.15.4.2 - Long Condor

The long condor is an extension of the long butterfly, because the profitable area will be amplified. Important for this strategy, all four positions possess a different strike price. Further, the long calls that define the edges of the strategy are each with a lower and a higher strike price than the ones sold.

The four different strike prices generate the four angles of the strategy, as it can be seen in the graph below. Moreover, the two sold call options have compared to the purchased call options a lower strike price. Consequently, the premiums of the two call options sold will not cover the costs for the purchase. Furthermore, a long condor can be assembled solely of call or put options.

Long Condor					
Activity	Position	Type	Strike	Amount	Maturity
Buy	Long	Call	ITM	1	equal
Sell	Short	Call	ITM	1	equal
Sell	Short	Call	OTM	1	equal
Buy	Long	Call	OTM	1	equal

Additionally, the long condor strategy implies a low price movement as well as a small volatility. In case of uncertainty about the direction of the price movement, the long condor strategy offers enough flexibility to benefit on both sides from small price movements.

The long condor will produce the maximum profit when the price of the underlying asset is between the two middle strike prices at maturity. Though, the maximum profit is defined by the difference of the two lowest strike price (ITM) less the debit spread. If the spot price should reach the OTM price of the sold call option, the profit will decrease.

On the contrary, the maximum loss is equal at both ends and is limited to the net debit of the premiums, regardless if the price of the underlying asset is at or below the lowest strike price or if it is at or above the highest strike price of the options. Also, the break-even points can be determined as in the other strategies as well. Here, they are found by the lowest strike plus the net premium and the highest strike less the net premium.¹⁵³

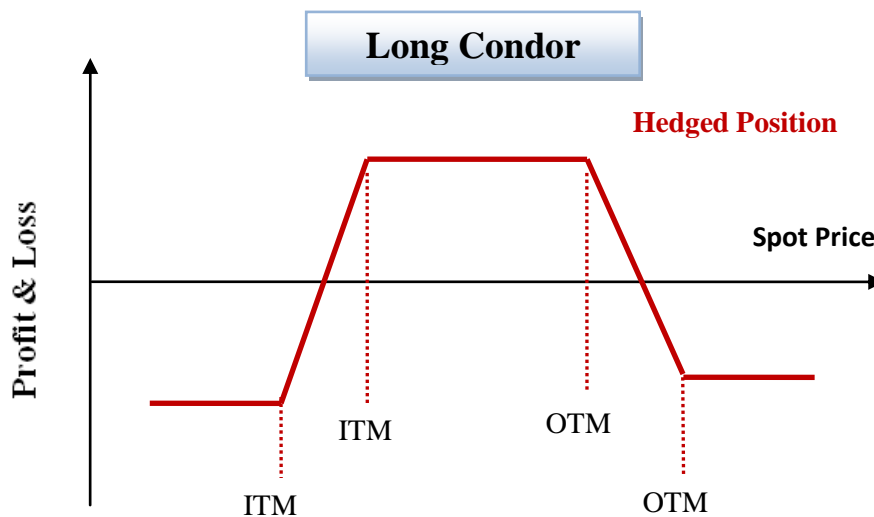

Consider that those strategies can be build by puts as well or imply a short strategy, which is the opposite the long strategies.

¹⁵³ C. Eck, M. Riechert, 2006, *Professionelles Eurex-Trading*. 3rd edition. München: FinanzBuch Verlag [p.185-186]
<http://www.options-trading-mastery.com/long-condor-spread.html> (12-02-11)
<http://www.theoptionsguide.com/condor.aspx> (12-02-11)

Appendix 2 – Futures

When looking at financial options and futures, several shy away, because they think they are not capable of trading on derivative exchanges. They may not feel to be experts in the field and see themselves facing the worse case of desperately losing a lot of money. Wrong, because futures are one of the easiest derivatives on the market. Why not buy an asset when the price is going to increase and sell when the price is going to fall? This is what futures are about. In the first instance, futures sound similar to financial option. According to the given circumstances one applies a specific strategy or position when the spot price of the underlying asset is expected to increase or decrease.¹⁵⁴

Appendix 2.1 – What are Forwards and Futures?

Since the main focus spreads out over futures, why is it necessary to mention forwards? Futures were based on forwards. Actually, both contracts embody the same attributes, but their difference underlies a detail. Forwards contracts are private agreements while future contracts are standardised contracts, traded on exchange markets.¹⁵⁵

With the help of forwards and futures the future price of financial instruments or commodities can be locked in today. These forward and future contracts are a contractual agreement between two parties whether to sell or buy a certain asset for a certain price at a certain future date. One party has to deliver the price and the other one the commodity or financial instrument agreed upon.

Financial forwards and futures comprehend the contractual agreement of two parties in which one needs to deliver (seller) and one needs to accept (buyer) a financial instrument or commodity contingently:

- To a certain point in time,
- To a certain quality,

¹⁵⁴ C. Eck, M. Riechert, 2006, *Professionelles Eurex-Trading*. 3rd edition. München: FinanzBuch Verlag [p. 215] http://www.1source4stocks.com/futures/futures_market.asp (03-01-11)

L.-Waldock, 2005, *The Complete Guide to Futures Trading*. New Jersey: John Wiley & Sons Inc. [p.1-2]

¹⁵⁵ C. Eck, M. Riechert, 2006, *Professionelles Eurex-Trading*. 3rd edition. München: FinanzBuch Verlag [p. 216] <http://www.ilikeinvesting.com/general-investment-articles/a-forward-contract.php> (22-02-11)

- To a certain amount, and
- To a certain price.¹⁵⁶

The purchase of a car, for example, is somehow a forward contract. Two parties sign a contract, one to buy and the other to sell the car at a fixed price. This implies already the difference between forwards and futures. In a forward contract the price is settled with a forward price in the beginning. Futures are settled at the end of a contract and underlie the daily changes in price.

However, whether buying a car or buying a holiday trip does not make a difference to a forward contract; because a forward contract is a contractual agreement upon a fixed price to deliver a good or agreement at a certain point in time.

Also, different than in forward contracts, is the other party in the contractual agreement of a future not directly specified. Additionally, forward contracts are only exchanged OTC while future contracts are traded on exchanges.¹⁵⁶

Example:

Once again, Mr. A and Mr. B (both farmer) exchange goods between each other. This time Mr. A wants to buy a forward-cow from Mr. B for a fixed price of € 1.000 to be delivered in one year. Both agree with a handshake (forward agreement) on the forward-cow. In one year, two scenarios can happen:

- The price of the cow increased to € 1.100 in the one year. Mr. A benefits from the forward-cow. He bought the cow for € 1.000 and is able to sell it immediately on the market for € 1.100, leaving him with a profit of € 100. On the opposite, if Mr. B would not have agreed on a forward contract, he could have sold the cow for € 1.100 today, filling his pocket with another € 100 cash.
- The price for the cow felt down to € 900. The lucky winner would be Mr. B, who sold the cow for € 1.000 to Mr. A. He can repurchase a cow on the market for € 900, which let him gain a profit of € 100 due to the difference in prices.

¹⁵⁶ <http://www.ilikeinvesting.com/general-investment-articles/a-forward-contract.php> (22-02-11)

The principles of forwards and futures are simple. If one expects that the prices are going to increase, the future demand can be fixed with a price today. Contrary, if one anticipates that prices are going to fall in the future, one can whether speculate or lock in a fixed price today for selling underlying asset or security in the future.¹⁵⁷

Appendix 2.2 – Characteristics of Futures¹⁵⁸

Appendix 2.2.1 – Positions

In future contracts (or multiple contracts) the positions are defined similar to the one of financial options. In a **long position**, one buys futures for a certain amount, a specific price, to a specific date with a certain quality. However, in a future contract one is obligated to pay on the due date to purchase the underlying asset. On the other hand, the **short position (selling)** commits to deliver the underlying security to the prior agreed conditions.

Appendix 2.2.2 – Settlement

As already mentioned before, futures are mostly traded in forms of commodities or financial instruments which could be currencies, indices, interest rates and others. Financial instruments are not tangible such as commodities and are handled by cash, because an index, for instance, cannot be physically delivered. Hence, one has to distinguish between **physical settlements** (commodities) and **cash settlements** (financial instruments) when trading with futures. Settlements take place at the end of a contract.

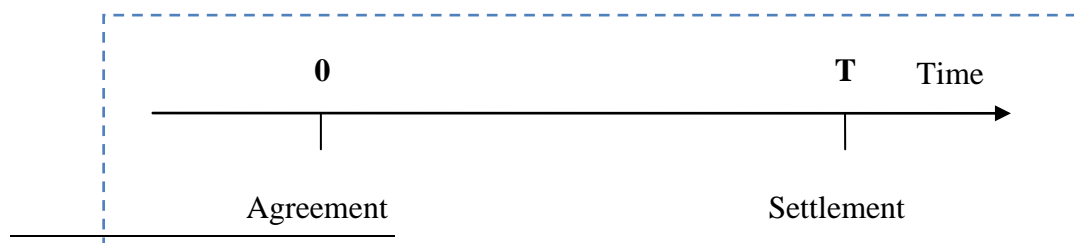

¹⁵⁷ C. Eck, M. Riechert, 2006, *Professionelles Eurex-Trading*. 3rd edition. München: FinanzBuch Verlag [p. 217-218]

¹⁵⁸ I. Uszczapowski, 2008, *Optionen und Futures verstehen – Grundlagen und neue Entwicklungen*. 6th edition. München: Deutscher Taschenbuch Verlag [217-226]

J.C. Hull, 2008, *Fundamentals of Futures and Option Markets*. 6th edition. New Jersey: Prentice Hall [p.17-23]

http://www.futurestradingpedia.com/futures_contracts.htm (03-01-11)

http://www.piptrader.com/contract_size.asp (25-02-11)

<http://daytrading.about.com/od/dtof/a/FuturesContract.htm> (25-02-11)

<http://web.mit.edu/15.407/file/Ch05.pdf> (25-02-11)

Appendix 2.2.3 – Maturity

With a future contract a maturity date will be settled as well. In general the expiration for futures vary depends on the contract and can expire in days, weeks, month or years. Further, depending on the exchange market, some can only expire to certain dates.

Appendix 2.2.4 – Contract Size

The contracts of futures can be single or multiple. Also, the size depends on the underlying asset traded, for example barrels for oil, or bushels of soybeans or ounces of gold have all different amounts.

Appendix 2.2.5 – Ticks

Another feature of futures is the tick. They describe the minimum price fluctuation of a future. In some cases a maximum fluctuation is set as well.

Appendix 2.2.6 – Margin

A future contract constitutes various margins. One of them, the **initial margin**, is a requirement of futures exchange to establish a buy or sell position of a futures contract. Everyone, who wants to trade with futures, needs to establish a margin account with a minimum deposit or balance, the **initial margin**. The initial margin can be a fixed amount or a percentage proportion of the contract.

Another margin is the **maintenance margin**. Generally, the maintenance margin is set at a lower price than the initial margin and determines the minimum mark for a futures contract account. If once, the margin drops below the maintenance requirements, a **margin call** is necessary to bring the account up again to the initial margin. Suppose a futures contract of a commodity was bought for an initial margin of € 500 and possesses a maintenance margin of

€ 400. Then, the price of the commodity drops, which let the value of the contract plunge to € 300.

This violation of the maintenance margin needs be levelled out by a margin call of € 200 to bring the account up again to its initial margin of € 500. If the trader is not able to make the margin call, the account will be liquidated and the remaining balance will be sold to others by the clearing house. When trading with multiple future positions the initial and maintenance margins will be cumulated and dealt as one together. While one can go up in profit some other positions might fall and force a margin call.

Another term is the **variation margin**. It describes the deviation from the initial margin and can be positive or negative, depending if it is a profit or a loss.¹⁵⁹

Appendix 2.3 – The clearing house

Forwards are private and personal agreements and are traded over the OTC. On the other hand, futures are standardized and only traded via exchange markets, which have rather relentless policies and engage a clearing house. A clearing house officiates as an intermediary or connector between the two parties and operates as the buyer to the seller and the seller to the buyer. It assures fair trade plus low transaction costs. Also, the clearing house, as neutral part of such futures contract, eliminates any risk of not fulfilling the commitment of the contracts. In case one party refuse to pay the agreed price or deliver the underlying security, the clearing house keeps it and sends the cash or underlying security back to the owner. Furthermore, the clearing house allows anonymity and thus, inhibits discriminating and manipulative behaviour on the market.

However, such secure trading through the clearing house requires some status. Not anyone is entitled to do forward trades on the market. The accreditation of trading on the derivative markets requires mostly, liquidity and a good credit rating. If someone speculates under a registered member, the person underlies the same requirements.¹⁶⁰

¹⁵⁹ I. Uszczapowski, 2008, *Optionen und Futures verstehen – Grundlagen und neue Entwicklungen*. 6th edition. München: Deutscher Taschenbuch Verlag [p. 217 – 221]

http://commodities.about.com/od/understandingthebasics/a/futures_margin.htm (25-12-2010)

¹⁶⁰ I. Uszczapowski, 2008, *Optionen und Futures verstehen – Grundlagen und neue Entwicklungen*. 6th edition. München: Deutscher Taschenbuch Verlag [p. 216 – 218]

Appendix 2.4 – Bid and Ask Prices

When looking at futures, the investor should get acquainted with two important terms when buying or selling futures. These two prices are also known under the synonym **bid** and **ask price**. The bid price describes the purchase price the investor or buyer is willing to pay for a future and the ask price expresses the selling price for which the seller is willing to sell. In fact the ask price is always higher than the bid price, which is known as the **bid-ask-spread**. For example:

BID (Buy)	ASK (Sell)
€ 100	€ 105

Note that if one wants to buy the underlying security, for instance, from a financial institution it will be sold at the ask price and if one sells the underlying security it will be bought at the bid price. This might sound confusing, but in fact the concept behind it prevents that investors, financial institution and others can make an immediate profit through a buying and selling of the underlying asset. The point of view determines which price needs to be used:

<u>Investor:</u>	<u>Financial Instit.:</u>
<ul style="list-style-type: none"> • Buying at ASK price • Selling at BID price 	<ul style="list-style-type: none"> • Selling at ASK price • Buying at BID price

Therefore, careful when reading bid and ask prices. Although, looking at the point of view from a FI, it could get an immediate profit. Again, a FI cannot buy and sell to its own conditions. They have to buy from another FI.¹⁶¹

J.C. Hull, 2008, *Fundamentals of Futures and Option Markets*. 6th edition. New Jersey: Prentice Hall [p. 26-27]

¹⁶¹ <http://www.stock-market-investors.com/stock-investing-basics/bid-and-ask-prices.html> (30-12-2010)

<http://www.finweb.com/investing/forex-bid-and-ask-price.html> (30-12-2010)

Appendix 2.5 – Costs of Futures

Appendix 2.5.1 – Cost of Carry

Recalling the example with the forward-cow, there are a few more remarks. The question that comes up might be who or how the prices for a commodity and a financial instrument are determined. In the example with the cow, whether the price of the cow rises or falls within one year has to do with the cost of carry.

Consider the costs of keeping the cow in the stable and feeding it over one year. These and other cost, for example, are compared with the benefits of a cow such as the milk it produces. Of course, would the cow generate more than it costs, the price of a cow will rise within one year. Literally, the cow becomes a “cash-cow”, which is actually a marketing term for a product or business unit that generates a lot of cash, but requires a low investment (carrying cost) and preserves a high market share.¹⁶² Then again, should the cow cost more than it might benefit, the market price for a cow will drop, because who wants to buy a cow that earns less than it costs.

The cost of carry will be always put across as the difference between the costs and the income. Therefore, if the cost of carry is positive, then the costs are higher than the income. On the other hand, a negative cost of carry induces that income overbalances the costs. Generally, almost the same assessment procedure as in the example with the forward-cow applies for commodities and financial instruments. Hence, such aspects as cost of carry and benefits are the drivers for the supply and demand, which ultimately shape the market price.¹⁶³

Appendix 2.5.2 – Transaction costs

Additionally, the trading of futures contracts include transaction costs, which should not be underestimated and can account for a significant amount. Sometimes, the transaction costs determine whether a futures contract is a profitable investment or not.

¹⁶² <http://www.quickmba.com/strategy/matrix/bcg/> (25-12-10)

¹⁶³ C. Eck, M. Riechert, 2006, *Professionelles Eurex-Trading*. 3rd edition. München: FinanzBuch Verlag [p. 218 – 219]

I. Uszczapowski, 2008, *Optionen und Futures verstehen – Grundlagen und neue Entwicklungen*. 6th edition. München: Deutscher Taschenbuch Verlag [p. 225 – 227]
<http://www.deifin.de/fuwi010.htm> (22-02-11)

Do not forget that in almost all the examples and explanations in this chapter, transaction costs were ignored. In most of the cases a perfect market was assumed, in which no transaction costs exist, unconstrained purchases can be done, credit and deposit rates are identical and the information about carrying costs are available for everyone.

Unfortunately, in the real world it looks a bit different. For the cost of carry concept some additional factors need to be taken into account such as transaction costs, risks and interest rates.¹⁶⁴

Appendix 2.6 –The convergence of Spot & Future price

The prices for futures are mostly stated higher than the spot price in the beginning because of its time value. However, in the beginning the futures are also more expensive, because the cost of carry exceeds the income. The difference between the futures and the spot price, called basis, is associated to the transaction costs and the cost of carry.

For a stock, for example, the costs of carry emerge in form of interest that needs to be paid in order to finance the purchase of the stocks. On the other hand, some stocks issued by companies pay dividends, which in return brings some income and will be settled with all other costs.

The more the future gets closer to maturity, the smaller is the difference between the future and the spot price, theoretically. At maturity the future and spot price will be almost identical, because the likelihood that the future will generate profits or losses is very slight. When the future is due, the basis will be zero.

The process of the future price approximating the price of the underlying asset until maturity is called the **convergence**.

¹⁶⁴ C. Eck, M. Riechert, 2006, *Professionelles Eurex-Trading*. 3rd edition. München: FinanzBuch Verlag [p.227 – 228]

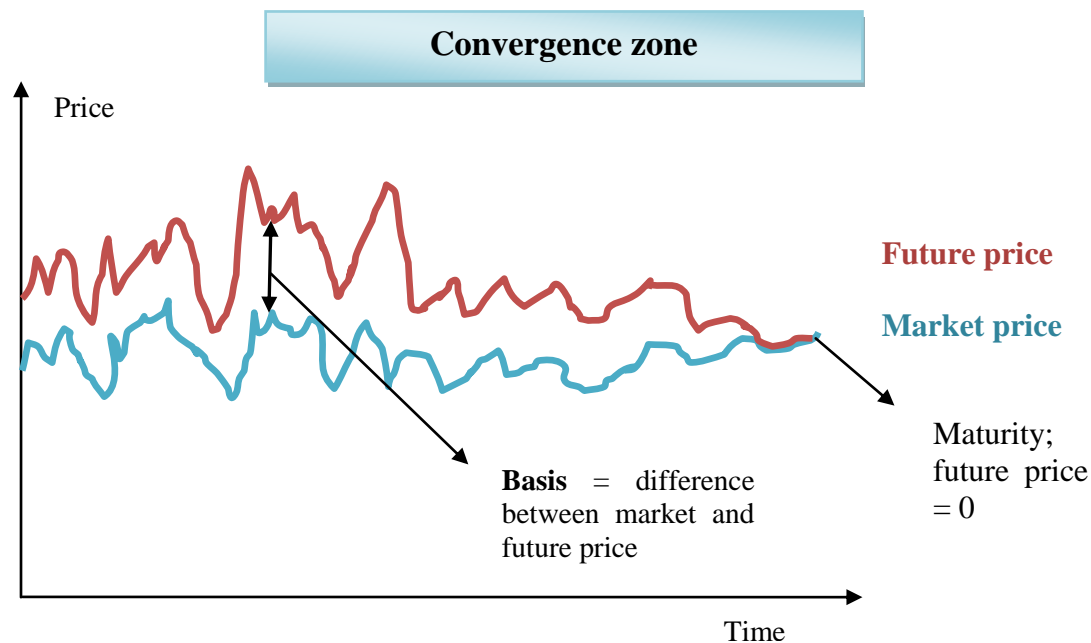

If a futures price is far too over- or underpriced, arbitrageur take advantage. Depending on the mispricing whether futures will be sold (bought) and the underlying asset bought (sold).¹⁶⁵

Appendix 2.7 – Futures pricing

Appendix 2.7.1 – Cost of carry approach

A simple approach to calculate the fair price for a future is based on the cost of carry. As the example with the cow and the chapter about cost of carry introduced, the approach is rather applicable to capital or producer goods (commodities).

Under the assumption that, everybody has the same access to information, no credit risk exists, unconstrained market competition, and some other factors, then the theoretical fair value of a future can be priced.

For the cost of carry approach drop the cost of opportunity for missed out interest income on the invested capital, because during the time until maturity, storage or delivery costs do not increase.

This leads to the simple assumption about the futures fair value:

¹⁶⁵ C. Eck, M. Riechert, 2006, *Professionelles Eurex-Trading*. 3rd edition. München: FinanzBuch Verlag [p. 238 – 240]

J.C. Hull, 2008, *Fundamentals of Futures and Option Markets*. 6th edition. New Jersey: Prentice Hall [p.19-20]
http://www.compareshares.com.au/expert_futures5.php (03-01-11)

$$F_{0,T} = S_0 + C$$

In which,

$F_{0,T}$ = Future price at time t=0, with maturity T

S_0 = actual market price of the stock at time t=0

C = Cost of carry, the difference between the cost and income (mostly presented in percentage terms)

If the relation in the equation fits, then the relation between the futures prices and the spot price (the basis) actually represents the cost of carry.

With this equation the following relation can be deduced as well:

$$C = S_{0,T} - F_0$$

In addition to the cost of carry approach, an alternative becomes effective as soon as the consumption good needs to be stored. Thereby, the cost of carry formula will be extended by the convenience yield, which a basic module for futures pricing, mainly for commodity products that require physical storage, based on supply and demand:

$$F_{0,T} = S_0 + C - y$$

In which,

C = only costs, no difference between costs and income

y = convenience yield (or income)

The convenience yield explains the chances of a shortage that can occur for the underlying asset (commodity). Thus, if one possesses and stores a good (commodity), which demand suddenly, escalates, he or she might be able to receive a high price for it. The other way around it represents the costs that users are willing to pay in order to insure themselves against shortfalls of supply. This gain of the sale, through a high price, might cover the cost of

carry entirely. Hence, the futures price will be noted less than the spot price to prevent advantages.¹⁶⁶

In view on the cost of carry and convenience yield, the upper and lower price limits for futures can be determined. If, the futures prices will be exceed or fall below these limits, then one can reap an arbitrage profit, because the price is assumed to be under- or overestimated.

Appendix 2.7.2 – Basic pricing

Based on the cost of carry approach, the conception can be extended for other products different than commodities such as stocks or indices for instance. For such products the cost of carry looks different since, it does not include storage or delivery costs, but share subscriptions rights to own the underlying asset.

At first, it will be assumed that the underlying security does generate additional income such as non-dividend stocks or for commodities it would be gold and silver.

Mathematically, the formula to determine the fair value of a futures contract, using a discrete interest rate, is expressed as followed:

$$F_{0,T} = S_0[(1 + i \times t)] \quad \text{or} \quad F_{0,T} = S_0(1 + i)^t$$

For continuous compound:

$$F_{0,T} = S_0 \times e^{i \times t}$$

In which,

- F_{0,T}** = Future price at time t=0, with maturity T
- S₀** = actual market price of the stock at time t=0
- e** = base for natural logarithms
- i** = interest rate (percentage term for the cost of carry)
- t** = rest time until maturity (depends on days, month n/360, n/12...)
in futures trading it is assumed that a month has 30 trading days(year: 360)

¹⁶⁶ I. Uszczapowski, 2008, *Optionen und Futures verstehen – Grundlagen und neue Entwicklungen*. 6th edition. München: Deutscher Taschenbuch Verlag [p. 225 – 229]

http://www.godmode-trader.de/wissen/index.php/Futures:Cost_of_carry (25-02-11)

<http://www.deifin.de/fuwi009c.htm> (25-02-11)

<http://www.jrank.org/finance/pages/6910/convenience-yield-%28Commodities%29.html> (05-04-11)

Depending on, whether the future was purchased or sold, the interest rate refers to the interest of a loan or for a deposit. The continuous compound interest rate is assumed when a stock, for instance, has a lognormal property. However, the difference to a discrete interest rate is minimal.¹⁶⁷

Appendix 2.7.3 – Dividend payments

Futures can also contain an underlying asset such as a stock that pays dividends. These dividends need to be incorporated, when calculating the future price. It is the same basis formula with a little amendment:

$$F_{t,T} = S_t \times (1 + i)^t - d$$

In which,

- t** = rest time until maturity (depends on days, month $n/360$, $n/12$...)
- d** = dividend payments (received during the lifespan of the futures contract)

The dividend payments can also appear to be a dividend yield, which is mostly the case for indices and can distributed more than once in year. Thus, the dividends can be calculated separately before deducting them. At first, the dividend payment needs to be calculated.

Assume the index spot value is 1,000 and has a dividend yield of 1.70 % for a year, then:

$$d_t = 1,000 \times 1.70 \% = 17 \text{ basis points}$$

The dividend payment needs to be discounted as well in order to be deducted:

$$d = \sum_{t=1}^n d_t \times (1 + i)^t$$

In which,

¹⁶⁷ http://www.godmode-trader.de/wissen/index.php/Futures:Cost_of_carry (25-02-11)

<http://www.deifin.de/fuwi009c.htm> (25-02-11)

<http://www.cmegroup.com/trading/equity-index/fairvalue.html> (25-02-11)

C. Eck, M. Riechert, 2006, *Professionelles Eurex-Trading*. 3rd edition. München: FinanzBuch Verlag [p. 222 – 225]

http://www.duke.edu/~charvey/Courses/ba350_1997/futures/lecture.htm (25-02-11)

- t** = is the time until the dividend payment
d = dividend payments (received during the lifespan of the futures contract)

Note that the interest rate needs to be adjusted for the discount of the dividend payments, because it is assumed that interest income can be earned on them. For a continuous compound valuation the formula looks different¹⁶⁸:

$$F_{t,T} = S_t \times e^{(i-d) \times t}$$

In which,

- d** = dividend yield

Appendix 2.7.4 – Arbitrage relationships

Remember that in earlier the cost of carry and the convenience yield can be used to form the upper and lower fair value limits for futures prices. However, the transaction costs need to be included to form approximate limits on both sides.

With the transaction costs in mind the formula for pricing futures needs to be restated:

$$F_{0,t} = S_0(1 + T)(1 + C)$$

In which,

S₀ = Spot price of the stock at time t=0

C = Cost of carry, the difference between the cost and income in percentage terms

T = Transaction costs

Consider that the trader has to pay on the purchase of futures contract on the stock price (**S₀**) transaction costs. In addition to the transaction costs that accrue the cost of carry (**C** = financing costs for an underlying asset different than commodity).

¹⁶⁸ <http://www.scribd.com/doc/51239701/49/Pricing-index-futures-given-expected-dividend-yield> (30-03-11)
<http://www.cmegroup.com/trading/equity-index/fairvalue.html> (30-03-11)

Further, for someone in the long position (buying the futures contract) transaction costs get added, while for someone in a short position the transaction costs get subtracted, which allows to form the boundaries for arbitrage free futures. Nonetheless, it is a theoretical model since the transaction costs for members, non-members and market makers are different in the real world. Therefore, the model represents the point of view for one of these participants.

$$S_0(1 - T)(1 + C) \leq F_{0,t} \leq S_0(1 + T)(1 + C)$$

Only if, the prices of futures cross these upper and lower boundaries, arbitrage opportunities arise, because then the futures price is whether over- or underestimated. Traders will pounce on these arbitrage opportunities until prices will be balanced again. ¹⁶⁹

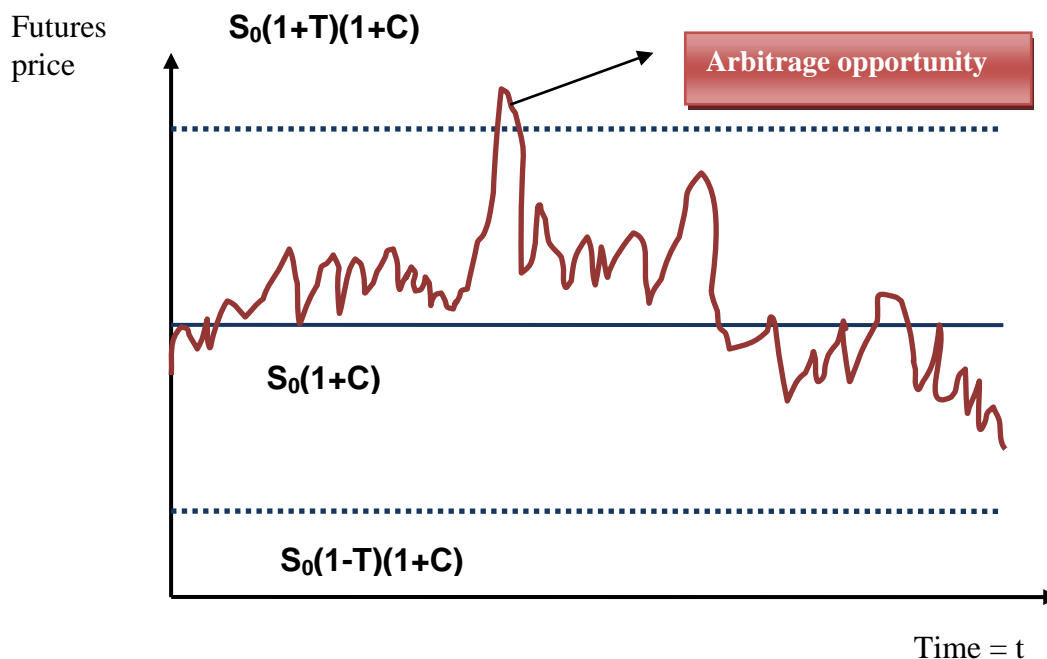

The horizontal line the in the middle describes the fair price of the future without transaction costs. The added transaction costs define the upper and lower limits. If the transaction costs increase, the respective upper and lower limits will increase as well.

However, one asks him or herself how could there be different transaction costs. The same applies, if the interest rates for a credit and for depositing are equal at the same time. However, this works only in a perfect market. Yet, the market is not perfect. Consequently, the interest rates are different for obtaining a credit or for depositing cash. Moreover, a bank

¹⁶⁹ C. Eck, M. Riechert, 2006, *Professionelles Eurex-Trading*. 3rd edition. München: FinanzBuch Verlag [p.232-233]

will offer their clients a lower rate for depositing than for obtaining a credit. The money they make with the spread between these interest rates yields their employees. Furthermore, as it is experienced in many companies, the employees get a discount on products or offerings. Thus, brokers get a better slightly better payoff when trading on the market than private investors.¹⁷⁰

Appendix 2.8 – Basic Futures strategies¹⁷¹

Apart from the day-to-day trading in futures, simple strategies involve buying a futures contract (going long, assuming the price is going to increase) and selling a futures contract (going short, assuming the price is going to decrease).

Appendix 2.8.1 – Going Long

In the long position, one buys a futures contract on an underlying asset and assumes that the price of the underlying asset is going to increase in the nearby future.

Thus, today the futures contract for a stock of company ABC will be locked in at a fixed price, for example, which matures in six month. For simplifications are transaction costs omitted. The following positions are taken in the example:

Futures - Long position					
Time	Activity	Position	Type	Amount	Maturity
Today	Buy	Long	Stock	1	6 Month
??	Sell	Short	Stock	1	??

Depending on how the spot price of the underlying asset develops, a futures contract will be sold. Example:

Going Long	
1 Contract	100 stocks

¹⁷⁰ I. Uszczapowski, 2008, *Optionen und Futures verstehen – Grundlagen und neue Entwicklungen*. 6th edition. München: Deutscher Taschenbuch Verlag [228-234]

C. Eck, M. Riechert, 2006, *Professionelles Eurex-Trading*. 3rd edition. München: FinanzBuch Verlag [p.229-232]

http://pages.stern.nyu.edu/~adamodar/New_Home_Page/invfables/futurearb.htm (26-02-11)

R.Kolb,J.A.Overdahl, 2007, *Futures, Options and Swaps*. 5th edition. New Jersey: Wiley-Blackwell [p.87-90]

¹⁷¹ <http://www.unitedfutures.com/futures-education/basic-trading-strategies.htm>

http://www.Isource4stocks.com/futures/trading_strategy.asp

1 Buy	Stock price	=	€ 10.00
	Time until Maturity	=	6 months
	<u>3 Month later:</u>		
	Stock price	=	€ 11.00
1 Sell	Stock price	=	€ 11.00
	Time until Maturity	=	3 months
	<u>At Maturity:</u>		
			-€ 10.00
			€ 11.00
			<u>€ 1.00</u>
	Result		€ 1.00

After three month the price of the stock increased by € 1. The trader will lock in the current spot price of € 11 to sell a futures contract due in three month, then when the other futures contract is due. At maturity he purchases the stock through the futures contract at a price of € 10 that he locked in six month ago and sells the stocks at a price of € 11 that he locked in three month ago. This results in a € 100 gain, since one futures contract equals 100 stocks of company ABC.

Of course, the opposite effect of the leverage can occur as well, when the price of the stock decreases, causing high losses. Then it makes sense to lock in the decreased price to prevent further losses, because the price of the stock might be able to decline further. Thus, it is a matter of speculating. Also, if the price would have dropped to a certain level, margin requirements are necessary and that can increase losses.

Appendix 2.8.1 – Going Short

Oppositely to the long position, the trader of futures contracts can also speculate on a decrease in price. At first, a price will be locked in to which the trader sells the underlying asset in the future. If the price is going to fall, he will lock in a price to which he will re-purchase the underlying asset and profit from the difference in price.

Futures - Short position					
Time	Activity	Position	Type	Amount	Maturity
Today	Sell	Short	Stock	1	6 Month
in 3 Month	Buy	Long	Stock	1	3 Month

The principles of this strategy are the opposite of going long. Here the same example as above is assumed, with the difference that the price is going to fall.

Going Short			
	1 Contract		100 stocks
1 Sell	Stock price	=	€ 10.00
	Time until Maturity	=	6 months
	<u>3 Month later:</u>		
	Stock price	=	€ 8.00
1 Buy	Stock price	=	€ 8.00
	Time until Maturity	=	3 months
	<u>At Maturity:</u>		
			€ 10.00
			-€ 8.00
	Result		€ 2.00

After three month the price of the stock decreased and the trader will lock in the price at which he will re-purchase the stock in three month, then when the other contract is due. Consequently, at maturity the trader benefits from the difference in prices, which are € 200. At first the stocks will be sold to the price of € 10 and then the stock will be re-purchased for € 8.

Again, this is just an optimal outcome. The price can also increase and hence, the strategy will not yield to any profit. Of course, it is always trivial. It could be that the price increase after two months on € 12. The trader will lock in a futures contract at € 12 to prevent higher losses, in case the price is going to increase further. However, one month before the maturity of both contracts, the price felt down to € 9. Such an unexpected turn cannot be perfectly predicted. Therefore, such strategies entail a certain level of risk, which comes along with the negative side effect of futures high leverage.

Appendix 2.9 – Arbitrage Futures strategies

However, arbitrage opportunities can also occur through a combination of long and short positions. This will allow to benefit from possible inequalities between prices. A “free lunch” an arbitrage risk-free profit can already be achieved through basic strategies.

Basic Futures Trading Strategy

Offset positions at a better price than it was paid for

Long position:

<u>Strategy:</u>	Buy low, Sell high								
<u>Example:</u>	Forward price for a one year future stock at € 300, Forward price for a two year future stock at € 330. No dividends paid. Actual interest rates at 5% for one and for two years. Assuming the two year future is overvalued								
<u>Initial position:</u>	Buy Future due in one year (on credit)								
<u>Offsetting position:</u>	Sell Future due in two years								
<u>Result after two years:</u>	<table border="0"> <tr> <td>Sell future</td> <td style="text-align: right;">€ 330</td> </tr> <tr> <td>Paying back credit for buying the future</td> <td style="text-align: right;">-€ 300</td> </tr> <tr> <td>interest credit (1 year at 5%)</td> <td style="text-align: right;">-€ 15</td> </tr> <tr> <td>Profit:</td> <td style="text-align: right;">€ 15</td> </tr> </table>	Sell future	€ 330	Paying back credit for buying the future	-€ 300	interest credit (1 year at 5%)	-€ 15	Profit:	€ 15
Sell future	€ 330								
Paying back credit for buying the future	-€ 300								
interest credit (1 year at 5%)	-€ 15								
Profit:	€ 15								

Short position:

<u>Strategy:</u>	Buy high, Sell low								
<u>Example:</u>	Forward price for a one year future stock rose to € 320, Forward price for a two year future stock still at € 330. No dividends paid. Actual interest rates at 5% for one and for two years. Taking a short position.								
<u>Initial position:</u>	Sell Future due in one year								
<u>Offsetting position:</u>	Buy Future due in two years								
<u>Result after two years:</u>	<table border="0"> <tr> <td>Buy future</td> <td style="text-align: right;">-€ 330</td> </tr> <tr> <td>Sold future one year ago</td> <td style="text-align: right;">€ 320</td> </tr> <tr> <td>deposited one year at 5%</td> <td style="text-align: right;">€ 16</td> </tr> <tr> <td>Profit:</td> <td style="text-align: right;">€ 6</td> </tr> </table>	Buy future	-€ 330	Sold future one year ago	€ 320	deposited one year at 5%	€ 16	Profit:	€ 6
Buy future	-€ 330								
Sold future one year ago	€ 320								
deposited one year at 5%	€ 16								
Profit:	€ 6								

172

¹⁷² R.R.Warendorf, 2000, *All About Futures – The easy way to get started*. 2nd edition. New York: McGraw Hill [p. 14]

Nevertheless, this is a simplification how an arbitrage strategy with help of basics can happen. However, those “free lunches” appear only for a very short time frame, because arbitrage traders pounce on such profits immediately, which will let market prices adapt and bring them up to normal again.

Appendix 3 – Eurex data

Appendix 3.1 – Eurex trading volume growth rates

$$\text{Annual growth} = \frac{((\text{volume year } t + 1) - (\text{volume year } t))}{\text{Volume year } t}$$

Year	2006	2007	2008	2009	2010
------	------	------	------	------	------

Total Volume	1,526,751,902	1,899,861,926	2,165,043,183	1,687,497,486	1,897,403,285
Percental growth		24.44%	13.96%	-22.06%	12.44%
From 2006 until 2010					24.28%
Average					7.19%

Appendix 3.2 – Eurex trading volume 2006 - 2010

Trading Volumes (in contracts traded)

Year/Month	Eurex Exchange Total	Eurex Interest Rate Derivate	Eurex Equity Index Derivate	Eurex Equity Derivate	ISE Total*
Feb 2011	142,131,030	48,627,488	58,377,631	34,420,766	60,962,016
Feb 2010	148,981,515	48,736,443	67,077,348	32,658,256	59,840,558
2010	1,897,403,285	574,810,201	805,111,732	511,053,917	745,175,111
2009	1,687,487,486	465,683,331	797,500,019	421,324,432	960,247,551
2008	2,165,043,183	658,250,515	1,026,643,557	479,541,752	1,007,661,590
2007	1,899,861,926	771,728,288	753,577,216	374,507,636	804,359,093
2006	1,526,751,902	731,215,924	487,367,500	308,132,141	591,961,518

*Note: ISE launched options trading on 26 May 2000

Source: http://www.eurexchange.com/download/documents/statistic1102_en.pdf (08-03-11)

Appendix 3.3 – Eurex trading volume 2010 by product group

Traded Contracts by Product Group

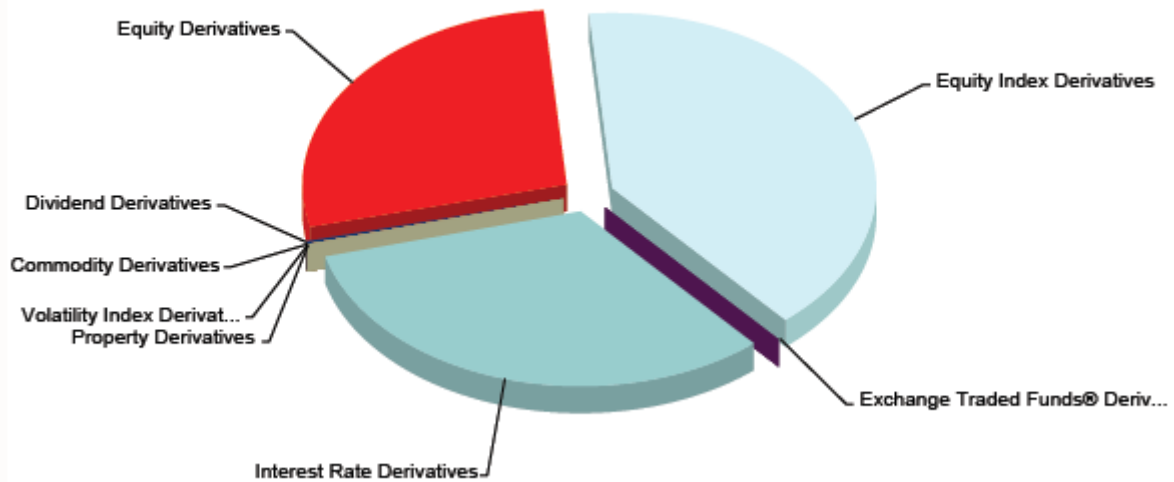

Source: http://www.eurexchange.com/download/statistics/monthly/monthlystat_201101.pdf (31-03-11)

Year 2010

Derivative	Traded contracts	in %
Equity index	805,111,732	42.44%
Interest Rate	574,810,201	30.30%
Equity	511,053,917	26.94%
Dividend	4,526,632	0.24%
Volatility	994,414	0.05%
Commodity	276,132	0.01%
ETF's	141,718	0.01%
Property	1,652	0.00%
Credit	0	0.00%
Inflation	0	0.00%
Weather	0	0.00%
Total	1,896,916,398	1

Appendix 3.4 – Eurex trading volume distribution¹⁷³

Eurex					
Year	2006	2007	2008	2009	2010
Options	566,119,605	753,675,226	933,350,116	758,530,120	661,667,764
Futures	960,632,297	1,080,831,450	1,231,693,067	928,967,366	1,153,431,457
Total Volume	1,526,751,902	1,899,861,926	2,165,043,183	1,687,497,486	1,897,403,285

Eurex trading distribution between options & futures (2006-2010)

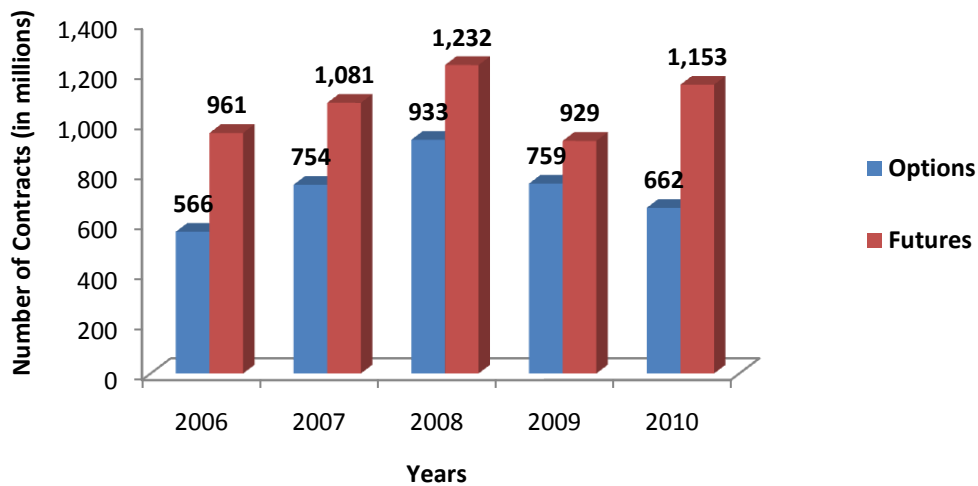

Eurex trading volume (which OTC) 2006 - 2010

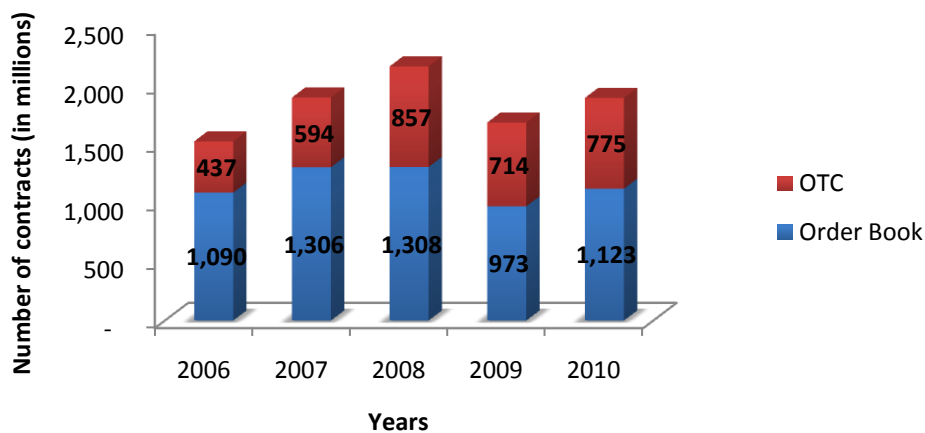

¹⁷³ http://www.eurexchange.com/download/statistics/monthly/monthlystat_201001.pdf (31-03-11)
http://www.eurexchange.com/download/statistics/monthly/monthlystat_201101.pdf (31-03-11)

Appendix 3.5 – Eurex rebate table (Options)

Options					
Product/ Product Group	Order Book & Wholesale Volume				
	Level 1	Level 2	Level 3	Level 4	Level 5
Rebate	20%	30%	40%	60%	80%
Equity Derivatives					
Equity Options	80.001	160.001	320.001	1.000.001	2.000.001
Equity Index Derivatives					
EURO STOXX 50® Index Options (incl. Weekly Options)	80.001	160.001	320.001	1.000.001	2.000.001
DAX® Options (incl. Weekly Options)	40.001	80.001	160.001	500.001	1.000.001
SMI® Options	4.001	8.001	16.001	50.001	100.001
Other Equity Index Options (aggregated)	10.001	20.001	30.001	50.001	70.001
Interest Rate Derivatives					
Options on Three-Month EURIBOR Futures	15.001	30.001	60.001	120.001	240.001
Options on Euro-Bund Futures, Options on Euro-Bobl Futures, Options on Euro-Schatz Futures	90.001	180.001	280.001	480.001	760.001

Source: http://www.eurexchange.com/trading/fees_en.html (08-03-11)

Appendix 4 – Liffe data

Appendix 4.1 – Liffe trading volume growth rates

$$\text{Annual growth} = \frac{((\text{volume year } t + 1) - (\text{volume year } t))}{\text{Volume year } t}$$

Year	2006	2007	2008	2009	2010
Total Volume	730,303,126	949,021,974	1,049,729,625	1,056,012,096	1,222,556,772
Percental growth		29.95%	10.61%	0.60%	15.77%
% growth from 2006 until 2010					67.40%
Average					14.23%

Appendix 4.2 – Liffe Trading Volume 2006 - 2010

LIFFE DERIVATIVE MARKET Trading Volume

Year	2006	2007	2008	2009	2010
Equity products (Individ. + Equity index)	307,470,232	417,806,991	481,605,915	526,170,729	618,226,012
<i>(which Bclear)</i>	52,798,530	122,775,815	190,874,390	260,950,339	340,840,217
Individual equity products	185,067,736	261,419,067	308,574,216	369,915,322	464,562,718
<i>(which Bclear)</i>	38,522,647	100,653,218	162,272,294	226,972,326	316,541,833
Futures	29,515,726	75,266,349	124,468,809	199,044,957	289,334,111
<i>(which Bclear) Futures</i>	23,553,100	72,381,422	120,859,997	197,708,667	288,206,994
Options	155,552,010	186,152,718	184,105,407	170,870,365	175,228,607
<i>(which Bclear) Options</i>	14,969,547	28,271,796	41,412,297	29,263,659	28,334,839
Equity index products	122,402,496	156,387,924	173,031,699	156,255,407	153,663,294
<i>(which Bclear)</i>	14,275,883	22,122,597	28,602,096	33,978,013	24,298,384
Futures	72,135,006	93,284,741	106,099,614	92,867,375	96,479,540
<i>(which Bclear) Futures</i>	3,140,270	4,872,429	5,290,669	8,046,459	7,511,705
Options	50,267,490	63,103,183	66,932,085	63,388,032	57,183,754
<i>(which Bclear) Options</i>	11,135,613	17,250,168	23,311,427	25,931,554	16,786,679
Interest rate products	412,239,663	517,932,820	554,878,193	517,700,337	587,651,754
<i>Short-term</i>	388,994,159	489,138,026	528,578,299	492,024,177	557,330,095
Futures	296,008,444	353,594,479	341,818,210	301,886,363	368,722,985

Convenience comparison of Options & Futures for an market entry
with view to Eurex & Liffe

Options	92,985,715	135,543,547	186,760,089	190,137,814	188,607,110
<i>Medium and long-term</i>	23,245,504	28,794,794	26,299,894	25,676,160	30,321,659
Futures	23,245,504	28,794,794	25,850,165	24,857,924	30,025,395
Options			449,729	818,236	296,264
Commodity products	9,851,385	12,783,848	13,245,517	12,141,030	16,679,006
Futures	9,124,195	11,496,659	11,787,197	10,600,717	14,133,913
Options	727,190	1,287,189	1,458,320	1,540,313	2,545,093
Other products**	741,846	498,315			
Futures	8,807	6,005			
Options	733,039	492,310			
Total Volume	730,303,126	949,021,974	1,049,729,625	1,056,012,096	1,222,556,772
Futures	430,037,682	562,443,027	610,023,995	629,257,336	798,695,944
Options	300,265,444	386,578,947	439,705,630	426,754,760	423,860,828
<i>(which Bclear)</i>	52,798,530	122,775,815	190,874,390	260,950,339	340,840,217

** include currency and derivative warrant products

Source: <http://www.euronext.com/statistics/results/statistics-7327-EN.html?reportTitle=Euronext.liffe%20monthly%20statistics&reportSubTitle=%28NextMonth%29&type=7&displayMode=3>

(10-03-11), Liffe Market Factbooks 2006 – 2010

Appendix 4.3 – Liffe trading volume distribution 2006 - 2010¹⁷⁴

Year	2006	2007	2008	2009	2010
Total Volume	730,303,126	949,021,974	1,049,729,625	1,056,012,096	1,222,556,772
Futures	430,037,682	562,443,027	610,023,995	629,257,336	798,695,944
% growth		30.8%	8.5%	3.2%	26.9%
Options	300,265,444	386,578,947	439,705,630	426,754,760	423,860,828
% growth		28.7%	13.7%	-2.9%	-0.7%

Liffe Trading Volume Distribution - 2006 - 2010

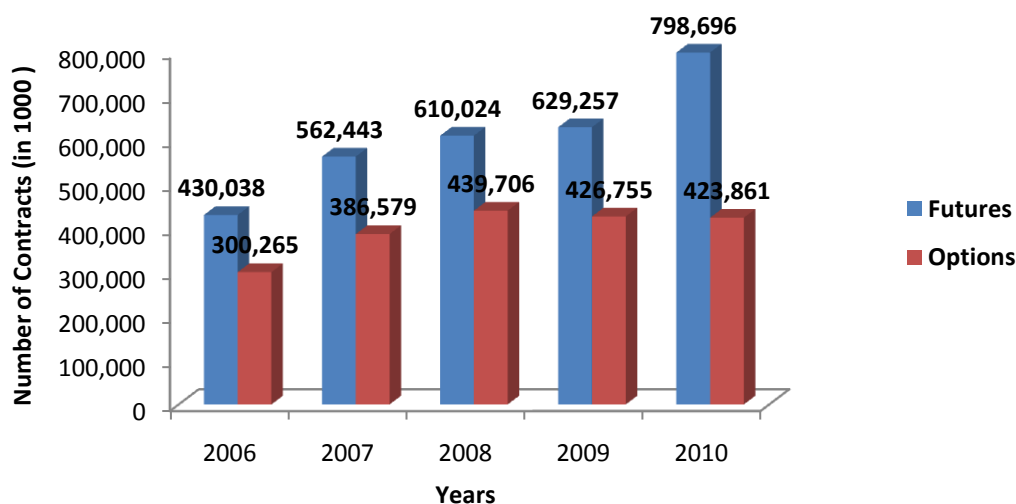

¹⁷⁴ http://www.eurexchange.com/download/statistics/monthly/monthlystat_201001.pdf (31-03-11)
http://www.eurexchange.com/download/statistics/monthly/monthlystat_201101.pdf (31-03-11)