

# ARCHITECTURE IN-PLAY

INTERNATIONAL CONFERENCES JULY 11<sup>th</sup>-12<sup>th</sup> 2016

**CONFERENCE  
PROCEEDINGS**

**ISCTE IUL**

Instituto Universitário de Lisboa

EDITED BY NUNO GUIMARÃES, ALEXANDRA PAIO, SANCHO OLIVEIRA,  
FILIPA CRESPO OSÓRIO AND MARIA JOÃO OLIVEIRA

© Instituto Universitário de Lisboa (ISCTE-IUL), Lisbon, 2016.

Instituto Universitário de Lisboa (ISCTE-IUL)

Forças Armadas Avenue, 1649-026 Lisboa

Tel. +351 790 3000

<http://www.iscte-iul.pt/>

All rights reserved.

© Nuno Guimarães, Alexandra Paio, Sancho Oliveira, Filipa Crespo Osório, Maria João Oliveira,  
editors.

© Architecture InPlay Conferences 2016

© in all texts, projects and images, are owned by their authors

This publication has its origin in the paper proceedings of the  
that was held in Lisbon, from 11th to 13th July 2016.

Edited by Instituto Universitário de Lisboa (ISCTE-IUL)

Architecture InPlay Conferences 2016,

curated by Alexandra Paio,

**Printed in Lisbon, Portugal, 2016**

Paper ISBN: **978-989-732-804-6**

Digital ISBN: **978-989-732-805-3**



## Index

|  |            |
|--|------------|
| <b>Michael Fox - Catalyst Design</b>   | <b>1</b>   |
| Syuko Kato, Ruairi Glynn - <i>Fabricating Performance: A dance of circular feedback processes in constructing spatial notion</i>   | 6          |
| Abdulbari Kutbi - <i>A Robotics of Trivial Mechanisms: The Pirouetting Picket Fence, From Trivial Embodiment to Complex Behaviours</i>   | 14         |
| Maria Genevieve Bezzone - <i>Interactive Architecture In The Digital Age- Parametric Design Of An Open Source Responsive Solar Filter</i>  | 22         |
| Jessica In, Chee Kit Lai - <i>hTYPER [hahy-per] [tahyp]: Interactivity and Performance in the exploration of architectural narratives</i>  | 30         |
| Begüm Aktaş and Şeyma Yıldırım - <i>Breathing Surface: Pattern Generation with Origami Tessellation</i>  | 38         |
| Avanti Dabholkar and Daniel Cardoso Llach - <i>Biometrically-Responsive Architecture: Mapping Biometric Data to Dynamic Spatial Change</i>   | 46         |
| Anna Grajper - <i>Playful experience within Interactive Architecture.</i>  | 53         |
| <b>Ruairi Glynn - Machine Life</b>   | <b>60</b>  |
| Sarah Mansour - <i>Parametric Design as a Design Tool for Adaptive Reuse in Interior Architecture: Studying daylight simulation and shading devices for enhancing building performance</i> | 69         |
| Marie Davidova and Vladimir Koci - <i>Choosing the Material for Environment Responsive Screen Ray: The LCA Comparison</i>  | 78         |
| Kevin Moreno Gata, Ernesto Echeverría Valiente - <i>Experimental Rooms: Integration of parametric tools for designing spaces. Structure, light and sound. Magic Spheres</i>                | 85         |
| Guzden Varinlioglu and Gazihan Alankus - <i>Unfolding Ancient Architecture Through Low Budget Virtual Reality Experience</i>   | 93         |
| Andrew Viny and Daniel Cardoso Llach - <i>[Y]OURS: Distributing Design Agency Through Playful Multi-Modal Interactors</i>  | 101        |
| Maria João de Oliveira and Vasco Rato - <i>Passive Shading System - Towards Parametric Definition And Virtual Simulation</i>   | 108        |
| Damjan Jovanovic, Adil Bokhari - <i>Games as a Model for Architectural Pedagogy: Production of architectural genres</i>  | 115        |
| <b>Arturo Tedeschi - Hyper-meritocracy and architecture</b>  | <b>122</b> |
| Giulia Curletto - <i>Rigid-Foldable Origami Structures: Parametric Modelling With Grasshopper - Geometric And Structural Issues</i>  | 126        |
| Parantap Bhatt, Nicolo Bencini, Spyros Efthymiou, Antoniya Stoitsova - <i>Reconfiguring Structural Assemblies Using Augmented Reality</i>  | 133        |
| Gonçalo Castro Henriques, Andrés Passaro - <i>Defying Gravity: From Statics To Dynamics, From Objects To Systems</i>   | 141        |
| Ines Caetano, António Leitão - <i>Exploring Buildings' Surface Patterns</i>  | 149        |
| Fernando Amen, Marcelo Álvarez, Víctor Vargas - <i>Utopia. Digital Fabrication Of Non-Built Architectures</i>  | 157        |
| Georgios Vlachodimos - <i>The Coherence Between Smart Objects And Artificial Intelligence In Architectural Digital Design Process</i>  | 163        |
| Alexandros Petenarelis - <i>Frei Otto's Contribution: Legacy To Parametric Design And Material Computation</i>   | 171        |
| Michele Calvano, Alfonso Oliva, Mia Tsiamis - <i>Articulated Surfaces: A Parametric Approach to Form-Finding and Structural Evaluation</i>   | 178        |
| <b>Paul Jackson - Folding as a Language of Design</b>  | <b>186</b> |
| Katerina Anagnostopoulou-Politou, Kinda Al Sayed - <i>Spatial Cognition In Virtual Environment. Spatial Cognition In Videogames</i>  | 195        |
| M Inês Chora, José Beirão, José Frutuoso - <i>Game Based Social Housing – Relocating Populations Via Game Based Participation</i>  | 203        |
| Joaquim Reis - <i>Origami: History, Folds, Bases And Napkins In The Art Of Folding</i>   | 211        |
| Cristina Veríssimo - <i>Cork: New Uses In Architecture</i>   | 219        |
| Mohamed Ibrahim - <i>Two Problems: Two Concepts: Two Grammars, Grammatical Exercises To Inspire Problem Solving In The Beginning Design Studio</i>   | 225        |
| Alessio Mazzucchi - <i>Modular Structures: A Kinetic Module Based On A Resch's Tessellation</i>  | 234        |
| Susana Neves, João Sousa, Filipa Osório - <i>Interactive Design For Everyone - From Folding To Programing</i>  | 241        |





## Foreword from the Program Chairs

On behalf of the organization, it is our great pleasure to welcome you and to present the proceedings of the International Conference Architecture In-Play held July 11–12, 2016 at ISCTE-IUL in Lisbon. The event is organized by a partnership between University Institute of Lisbon (ISCTE-IUL) and La Sapienza Università of Roma.

The possibility of hosting such an event at ISCTE-IUL emerged as a great opportunity to bring to Lisbon an international community to present the most recent and unpublished works in research, teaching or practice related to interdisciplinary use of Architecture, Digital Design, Technology, Computation, Mathematics and Geometry. In consequence, contribute to enrich the debate around the use of digital technologies in architecture. The focus of Architecture In-Play is exactly to think about responsive buildings, buildings that reshape themselves in order to respond to a particular need, interdisciplinary approach in Architecture, tools, methods and theories. In sum, bringing together people from all the fields that can merge and create new and improved architectural solutions.

The conference program represents the efforts of many people. We would like to express our gratitude to the Scientific Committee for their hard work in reviewing submissions and selection of the final papers. We are grateful to the authors (from 15 countries) of the papers for their contributions and their participation in the conference. The paper submission and reviewing process was managed using the EasyChair system. The list of reviewers is included in the proceedings.

We also thank the four invited speakers, Michael Fox (FOXLIN Architecture, United States of America), Ruairi Glynn (Interactive Architecture Lab at the Bartlett School, United kingdom), Arturo Tedeschi (Computational designer, Italy) and Paul Jackson (Origami Artist, Israel) for sharing their valuable experiences.

The Architecture In-Play conference is structured in four thematic sessions: (1) Interactive Architecture – adaptive world; (1) Interactive Architecture – laboratory; (2) Computational design; (3) Origami Geometry and Mathematics. Each session starts with lectures by international keynote speakers in the field, that share with the audience some of their most representative work in teaching, researching and practice, followed by paper presentation sessions. At the end of each session the debate allow a reflection on different approaches and results.

We hope that these proceedings can further stimulate research in different subjects and provide practitioners with better methods, tools techniques for architectural design. Hopefully, provide a point of departure for even greater achievements in the field.

Finally, we feel honored and privileged to provide the most recent developments in the field of Interactive architecture, computational design and origami to you through this exciting program. Conference Chairs,

Alexandra Paio, ISCTE-IUL, ISTAR-IUL, Vitruvius Fablab - IUL

Sancho Oliveira, ISCTE-IUL, IT-IUL, Vitruvius Fablab – IUL

Nuno Guimarães, ISTAR-IUL ISCTE-IUL, ISTAR-IUL

## Scientific Committee

- Benamy Turkienicz**, Federal University of Rio Grande do Sul (UFRGS), Porto Alegre, Brazil
- Carol Moukheiber**, John H. Daniels Faculty of Architecture, Landscape and Design –  
University of Toronto, Canada
- Claudia Pasquero**, University College London (UCL), London, UK
- Cornelie Leopold**, Faculty of Architecture, Technical University of Kaiserslautern,  
Kaiserslautern, Germany
- Daniel Cardoso**, Carnegie Mellon University (CMU), Pittsburgh, USA
- Eliana Pinho**, Faculty of Architecture - University of Porto (FAUP), Oporto, Portugal
- Elina Pattichi**, University of Cyprus, Nicosia, Cyprus
- Gonçalo Castro Henriques**, Federal University of Rio de Janeiro (UFRJ), Rio de Janeiro,  
Brazil
- Henri Achten**, Faculty of Architecture, Czech Technical University, Prague, Czech Republic
- Joaquim Reis**, ISCTE University Institute of Lisbon (ISCTE-IUL), Lisbon, Portugal
- José Pedro Sousa**, Faculty of Architecture - University of Porto, Oporto, Portugal
- José Pinto Duarte**, Faculty of Architecture - University of Lisbon (FAUL), Lisbon, Portugal
- Léia Bruscato**, Federal University of Rio Grande do Sul (UFRGS), Porto Alegre, Brazil
- Mário Kong**, Faculty of Architecture - University of Lisbon (FAUL), Lisbon, Portugal
- Nicolai Steinø**, Aalborg University, Aalborg, Denmark
- Nuno Guimarães**, ISCTE University Institute of Lisbon (ISCTE-IUL), Lisbon, Portugal
- Pablo C. Herrera**, Peruvian University of Applied Sciences (UPC), Lima, Peru
- Pedro Januário**, Faculty of Architecture - University of Lisbon (FAUL), Lisbon, Portugal
- Regiane Trevisan Pupo**, Federal University of Santa Catarina (UFSC), Florianópolis, Brasil
- Sema Alaçam**, Istanbul Technical University, Istanbul, Turkey

## Organization Committee

- Alexandra Paio**, ISCTE-IUL, ISTAR-IUL, VFabLab
- Graziano Valenti**, La Sapienza, Facoltà di Architettura
- Sancho Oliveira**, ISCTE-IUL, IT-IUL, VFabLab
- Nuno Guimarães**, ISCTE-IUL, ISTAR-IUL
- Andrea Casale**, La Sapienza, Facoltà di Architettura
- Michele Calvano**, La Sapienza, Facoltà di Architettura
- Filipa Osório**, ISCTE-IUL, ISTAR-IUL
- Maria João Oliveira**, ISCTE-IUL, DINAMIA'CET-IUL, VFabLAB
- João Sousa**, ISCTE-IUL, VFabLab
- Susana Neves**, ISCTE-IUL, VFabLab
- Vasco Craveiro Costa**, ISCTE-IUL, IT-IUL

### **Michael Fox**

*Foxlin Architecture*

*Los Angeles, USA*

As we embrace a world in which the lines between the physical and the digital are increasingly blurred, we see a maturing vision for architecture that actively participates in our lives. In the few years since the original *Interactive Architecture* was published, a number of projects have been built at scales that both move beyond the scope of the architectural exhibit as test bed and push the boundaries of our thinking in terms of material performance, connectivity, and control. Our architectural surroundings have become so inextricably tied to technological trends that the two ultimately and simultaneously respond to and define each other. The promise of ubiquitous computing has secured a permanent foothold in our lives and has begun to infiltrate our devices and objects as well as our buildings and environments.

Such is our physical world: not just digital but also seamlessly networked and connected, an architectural world that is a direct participant in our lives. Bill Gates once predicted that by the end of the first decade of the twenty-first century there would be nothing untouched by the digital.<sup>1</sup> By the end of the second decade, states interaction designer Behnaz Farahi Bouzanjani, this impact will arguably have become so pervasive that computation will not be noticeable anymore.<sup>2</sup> The subject of this book is how architectural design integrates and negotiates the digital; in our contemporary context, this is nothing short of reciprocal innovation. This book surveys the rapidly evolving landscape of projects and trends that are finally catching up with the past. As a matter of definition, interactive architectural environments are built upon the convergence of embedded computation and a physical counterpart that satisfies adaptation within the framework of interaction. It encompasses both buildings and environments that have been designed to respond, adapt, change, and come to life.

Young designers have started to realize that it is possible to build anything they can imagine.

Sensors available today can discern almost anything from complex gestures to CO2 emissions to hair color. An interconnected digital world means, in addition to having sensory perception, that data sets—ranging from Internet usage to traffic patterns and crowd behaviors—can be drivers of interactive buildings or environments. Courses in robotic prototyping and interaction are commonly taught in today's architecture programs, with contextual subjects ranging from urban social issues to practical sustainability. Perhaps equally as important as the rapid advance of such technologies is the fact that both robotics and interaction are technically and economically accessible. The requisite technologies are simple enough to enable designers who are not experts in computer science to prototype their ideas in an affordable way and



communicate their design intent. Architects and designers are not expected, as on exhibit-scale projects, to execute their interactive designs alone; they are expected rather to possess enough foundational knowledge in the area to contribute. In the same way, while architects need to learn structural engineering in school and, until recently, have been required to pass a special section on structures for the professional licensing exam, it is rarely assumed that architects will do the structural calculations for the buildings they design; that work is carried out by professional structural engineers.

The field is fresh with original ideas, illuminated by the built prototypes and architectural projects illustrated in this book. Driven by the applications, these genuinely new developments and ideas

will rapidly foster advanced thinking within the discipline; yet it is important to understand that their foundations have been around for quite some time, dating back nearly thirty years.

### **Catching up with the past**

Essentially, the theoretical work of a number of people working in cybernetics in the early 1960s laid most of the groundwork for the projects highlighted in this book. During this time, Gordon Pask, Norbert Wiener, and other cyberneticians made advancements toward understanding and identifying the field of interactive architecture by formulating their theories on the topic. Pask's conversation theory informed much of the original development in interactive architecture, basically establishing a model by which architects interpreted spaces and users as complete feedback systems.<sup>3</sup> Cybernetic theory continued to be developed into the late sixties and early seventies by the likes of Warren Brody, Nicholas Negroponte, Charles Eastman, Andrew Rabeneck, and others, who expanded upon the earlier ideas of Pask and Wiener. These early philosophies were then picked up by a few architects who solidly translated them into the arena of architecture. This work generally remained in the realm of paper architecture, however. Cedric Price was perhaps the most influential of the early architects to adopt the initial theoretical work in cybernetics, expanding it into the architectural concept of anticipatory architecture. John Frazer extended Price's ideas in positing that architecture should be a "living, evolving thing."<sup>4</sup> Yet it is important to understand that, while architects were developing these concepts, areas of digital computation and human interaction were advancing in parallel fashion within the sphere of computer science. From this work, fields such as intelligent environments (IE) were formed to study spaces with embedded computation and communication technologies, in turn creating spaces that bring computation into the physical world. Intelligent environments are defined as spaces in which computation is seamlessly used to enhance ordinary activity.<sup>5</sup> Numerous technologies were developed in this area to deal with sensory perception and human behaviors, but the corresponding architecture was always secondary as it was developed under the mantra of "seamlessly embedded computation." In other words, there was very little architectural involvement in the developing field of computationally enhanced environments. Corporate interests, meanwhile, established market-driven interests that played a major role in

## Catalyst Design

computationally enhanced environments through the development of numerous market-driven products and systems that directly involved users in the real world. In the 1990s there were “smart home” and “smart workplace” projects being initiated at every turn that relished the newly available technologies. For the first time, wireless networks, embedded computation, and sensor effectors became both technologically and economically feasible to implement by computer science. This feasibility fueled experimentation with many of the ideas of the previously mentioned visionary architects and theoreticians, who had been stifled by the technological and economic hurdles of their day. We are now at a time when the economics of affordable computational hardware and increased aptitude for integrating computational intelligence into our environments has become accessible to architects.

### **A connected world**

The influence of technological and economic feasibility within a connected world has resulted in the explosion of current exploration with the foundations of interaction design in architecture. The Internet of Things (IoT) has quite rapidly come to define the technological context of interactive design as all-inclusive, existing within this connectedness in a way that affects essentially everything, from graphics to objects to buildings to cities. To use an architectural analogy, the theoretical foundations have a structure that resides in the connected worlds of Web and mobile and spatial interfacing, and they are still evolving. Theories of a connected architectural world existed long before mobile devices and Web-interface technologies changed every aspect of our lives and created the discipline of interaction design.

While the first wave of connectivity focused on human-to-human communication, the current focus is on connected things and devices, which extends naturally to buildings, cities, and global environments. There are approximately one billion websites and about five billion mobile phones, while there are approximately fifty billion smart devices.<sup>6</sup> It is the goal (and responsibility) of the Internet of Things to connect them in a meaningful way.<sup>7</sup> These intelligent things are everywhere in our lives, and many of them are already seamlessly embedded in our architecture, from our kitchen appliances and our HVAC (heating, ventilation, and air conditioning) systems to our home entertainment systems. For the time being, most of them are weakly connected at best. Today the Internet supports hundreds of protocols, and it will support hundreds more. While the world struggles with a protocol platform, the battle over which protocol will prevail is being waged at a staggering commercial cost, often referred to as the “protocol wars.”

There are numerous contenders in the game—the IoT needs many. Currently heading the pack are CoAP, MQTT, and XMPP. The important difference between them lies in the distinction of application or the class of use. Devices must communicate with each other (D2D); device data must then be collected and sent to the server infrastructure (D2S). That server infrastructure has to share device data (S2S), possibly providing it back to devices, to analysis programs, or to people.<sup>8</sup> Eventually, all of these connected things will need an infrastructure to enable them to work together. There are a number of companies currently vying for position; their approaches range from

cloud-based software (with precedent in things like vending-machine inventory and engine maintenance) to ultranarrow-band radio transmissions. More than likely, the familiar tech trend will prevail: all of the novel small companies with their individual takes

on a similar problem will be pounced on by Apple, Microsoft, or Google, who will then take the best of each of them and create their own platforms. The goal of these big companies is to lock everything into their powerful existing systems.

There is currently a need for standardization to avoid having one of the big companies determine this eventual fate, which could indeed result in a nightmare where nothing works outside a proprietary system. “By embracing open standards, we can ensure we won’t be locked out of a device or forced to use only one type of connector at the whim of a single company,” says Mat Honan in WIRED magazine.<sup>9</sup> We have in the past embraced such standards, whereby almost all mobile devices already communicate via the same Bluetooth wireless standard. The point is that every existing company needs to rally behind a common standard—and do it soon. Scott Fisher, the founding chair of the Interdivisional Media Arts + Practice (iMAP) PhD program of the School of Cinematic Arts at the University of Southern California, observes: “The growing number of ubiquitous and embedded computing technologies introduces a new paradigm for how we interact with the built environment, while mobile and pervasive devices offer new possibilities for sensing and communicating with buildings and objects in the physical world. These technologies are used not only for collecting and providing data, but also as a way to animate and collectively augment the world around us.”<sup>10</sup> Interactions are no longer limited to those of people interacting with an object, environment, or building, but can now be carried out as part of a larger ecosystem of connected objects, environments, and buildings that autonomously interact with each other. Much of the work at iMAP has been focused on creating interactive architectural environments in which the buildings themselves become storytelling characters. As design researcher Jen Stein states, “By inviting inhabitants to engage with both the building and other inhabitants, we have introduced a new paradigm for place making within an animated, interactive environment.”<sup>11</sup> Usman Haque is a designer with a background in interactive architecture who has led the way in developing a scalable platform for connectivity with Pachube, which provides a platform for connecting various sensor data and visualizations. Through the development of an Extended Environmental Markup Language (EEML), the platform handles both Web-based and mobile applications for the sharing of sensory and environmental data in real time. Pachube was acquired by COSM, then acquired by Xively (LogMeIn), which encourages open digital ecosystems, connecting more than 250 million devices, including electricity meters, weather stations, building-management systems, air-quality stations, and biosensors, to name just a few.

Architectural applications are iterative in such a connected context. The sensors and robotic components are now both affordable and simple enough for the design community to access; and all of the parts can easily be digitally connected to each other. Designing interactive architecture in particular is not inventing so much as understanding what technology exists and extrapolating from it to suit an architectural vision. In this respect, the designers of buildings, cities, and larger interconnected ecosystems have learned a great deal from the rapidly developing field

## Catalyst Design

of tangible interaction, essentially an alternate vision for interfacing that was developed to bring computing back into the real world. Tangible user interfaces were envisioned as an alternative to graphical displays, an alternative that would bring some of the richness of the interaction we have with physical devices back into our interaction with digital content.<sup>12</sup> In contrast, the field of industrial design came to engage with tangible interaction out of necessity as appliances became progressively “intelligent,” containing more and more electronic and digital components.<sup>13</sup> Broadly, tangible interaction encompasses user interfaces and interaction approaches that emphasize the sensory appeal and materiality of the interface, the physical embodiment of data, whole-body interaction, and the embedding of the interface and the users’ interaction in real spaces and contexts.

Tangible interaction is a highly interdisciplinary area. It spans a variety of perspectives, among them human-computer interaction (HCI) and interaction design, but specializes in interfaces or systems that are in some way physically embodied. Furthermore, it has connections with product and industrial design, arts, and architecture. In a sense, interactive architecture falls under the umbrella of tangible interaction along with environments and physical- artifact, product, and industrial design, only the scale is often much larger. Although tangible interaction typically deals with the interfacing of objects and artifacts, the connected capabilities have opened up a wealth of possibilities not only at the scale of the building, but also in the city and beyond. One of the pioneers in this area has been the MIT SENSEable City lab, led by Carlo Ratti (who also comes from a background in architecture). The lab has done extensive research into how real-time data generated by sensors, mobile phones, and other ubiquitous technologies can teach us how cities are used and how new technologies will ultimately redefine the urban landscape. Ratti argues that urban planning is not just about cities, but about understanding the combination of physical and digital. Ratti says “[T]he interesting thing is that now the machine, the computer, is becoming the city. The city has become the interface—to retrieve information, to meet other people, to do all the things happening now with this mixing of bits and atoms. So it’s this new exciting equation, putting together people, space, and technology.”<sup>14</sup> Additionally, the Situated Technologies initiative, led by Omar Kahn, Trebor Scholz, and Mark Shepard, has had a major influence in this area through symposia, competitions, and publications. The initiative, which emerges from architecture as opposed to computer science, takes into account the social dimension of ubiquitous computing.

It is impossible to predict how quickly interactive architecture will be widely executed or what standards and protocols will work their way to the fore. Yet such standards and protocols are becoming an inevitable and completely integral part of how we will make our buildings environments and cities in the future. The platform is ripe to foster unique applications tied to our living trends, which both affect and are affected by digital technology. Within a profession recently dominated by a discourse of style, we have begun to detect a shift away from questions of representation and images toward processes and behaviors.<sup>15</sup> Specific categorical areas have consequently come to the fore as designers have forged ahead to pioneer this new area of design.



# Fabricating Performance: A dance of circular feedback processes in constructing spatial notion

**Syuko Kato**

UCL

*katosyuko@gmail.com*

**Ruairi Glynn**

UCL

*r@ruairiglynn.co.uk*

**Abstract:** The analogue and digital notational systems for documenting choreographic movement provide promising alternative strategies for spatial design. These strategies overlap architectural design and dance choreography to explore reciprocal exchanges regarding the body, geometry and methods of spatial notation.

Analogue and digital notational systems are compared to illustrate a change where, instead of simply recording a performance, the notation is fed back to the performer and used as inspiration for further iterative performances. Whilst the use of analogue notation systems support the criterion of fundamental design, they have limitations which are overcome with the use of flexible digital systems that more readily adapt to change and interrelate to dancer's intentions for movement creation.

Performance-driven fabrication explores practical application of this process. Two stages of 'Performance-driven design' and 'Data-driven fabrication' are combined resulting in a spatial design and construction system that incorporates interactivity between human and robotic performers. As in dance choreography, the motion dynamics of the participants supply data driving the fabrication that, in turn, is fed back to the inhabitants in an iterative process.

**Keywords:** *notation; choreography; performance; fabrication; robotics*

## Introduction

The relationship between architecture and choreography in the construction of space has been a constant source of discussion between architects and choreographers since the 1900s. Reciprocal exchanges of language to discuss the body and its geometry have been assimilated, often altering the meanings of these terms and offering designers and artists new insights into the creative process.

However, architectural drawings rarely capture moving factors typically illustrating frozen conditions, they fail to convey changing environments of human life and its energy.

Digital technologies can address the problem of notating moving elements in dance choreography and architectural design. This paper explores design tools that employ a concept of movement. Subsequently the method is tried and tested on the creation of a spatial environment.

Rudolf von Laban (1879-1958) introduced the term *quality of movement* in relation to spatial interaction - the interconnection of geometry & movement and how physical motion is notated. In this context, Laban conducted research on an icosahedron model (Figure 1), producing diagrams entitled *Labanotation* (1926, Fig. 1), many choreographers have further built on his work.

## A dance of circular feedback processes in constructing spatial notion

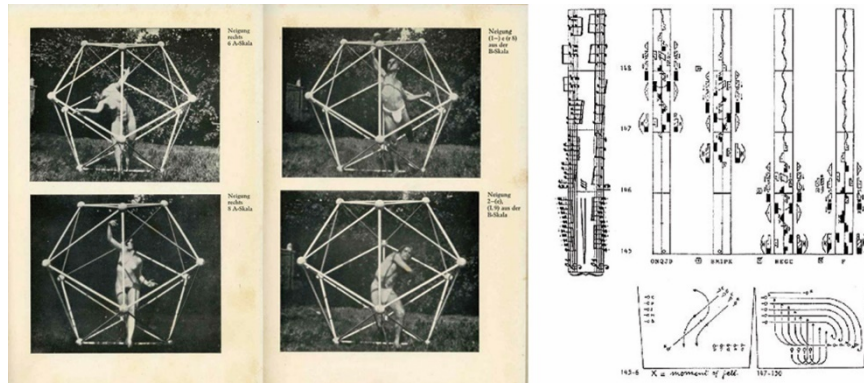

Figure 1. Laban with Icosahedron model / Labanotation

The observed *quality of movement* in Laban's research has a Euclidean exactness. Human sized physical models allowed visual analysis, that could be transcribed into rhythmic patterns, and informed notation. Concurrently Euclidean geometry was helping to describe the *quality of movement* of 'Jitterbug'. Buckminster Fuller (1895-1983) used a kinetic model that morphed between icosahedron, cuboctahedron, tetrahedron and octahedron (Fig. 2).

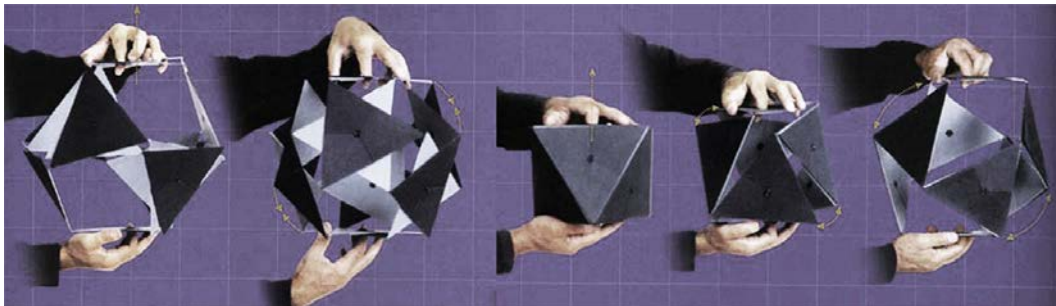

Figure 2. Buckminster Fuller's 'Jitterbug' model

### 1. What value the notation of choreography and architecture?

In the search for defining alternative tools for choreographing movement, it is essential to identify the information of movement (i.e. speed, accent), as well as the physical form of it (i.e. geometry, position, angle). Architects and choreographers attempts of analogue notation are analysed.

#### 1.1 The role of notation in architecture

Drawings and descriptions of designs give architects the means to mediate the relationship between themselves, client and building, setting the rules for negotiation between concept and realisation. Gage (2007) argues for Architects to consider behavioural rules in design and how adaptability and habitation affect occupation of designed space. Notation of movement here may help to predict behaviour.

Notation methods are pivotal in some information diagrams. In the 'Fun Palace' Cedric Price (1934-2003) used mechanical systems to programmatically actuate his building. He used diagrams to explain the movement and behaviours of people and services and notate habitable conditions in the context of a moving building with free flowing people (Fig. 3). Notation allows coherent communication of function and experience.

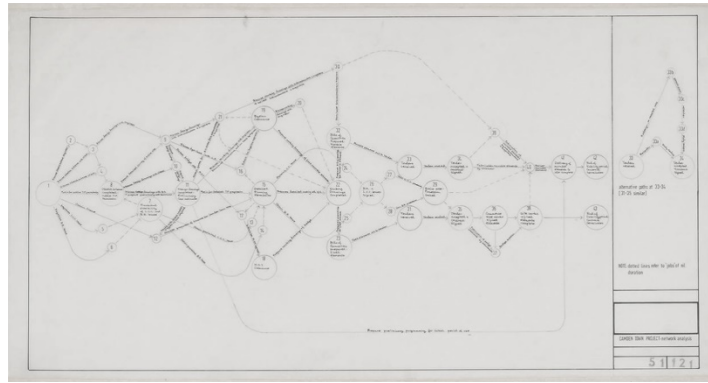

Figure 3. Network analysis diagram for Fun Palace

Following Price's approach, Tschumi (1996) devised modes of notation derived from choreography to expose the complexity of phenomena in architecture and culture he wished to communicate.



Figure 4. Screenplays and The Manhattan Transcripts

Here movement becomes contextual information capturing the implications of spatial arrangement on participation and occupation. The essence of movement appears in drawings and diagrams but the dynamics of interaction between user and space fail to be captured.

### 1.2 The role of notation in dance choreography

Transcribing dance challenges the creative process of choreography. An analogue process traces a transient segment into a frozen state on paper. Languages have developed to expediently notate movement. Trisha Brown, *Locus* (Fig. 5, left), coopted Mathematics to describe movement. Her Scores required dancers to move sequentially through numbered points in a cubed format space.

## A dance of circular feedback processes in constructing spatial notion

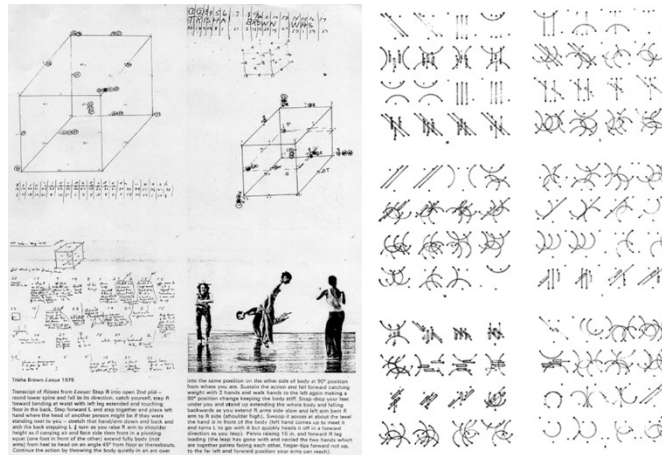

Figure 5. 'Locus' (1975) / 'Melody Excerpt' (1977)

In contrast Lucinda Childs's notations (Fig. 5, right) simultaneously arrange multiple dancers' movements in larger space. Weinstein (2013) explains this successfully organises rhythms and patterns to be executed, as opposed to *Labanotation*, which "does not convey full scalar spectrum of information". This highlights the discrepancy in notations and difference in transcribing movements.

Such attempts show notations cannot simply extract geometrical position information and relay it as two-dimensional records. Where Brown annotates quantitative factors in space, Childs choreographic procedure presents contextual movement in patterns to be interpreted. Analogue techniques now form the basis for notation but have limitations in specificity of movement and scope with multiple dancers.

## 2. What tools measure the perceived *quality* of movement?

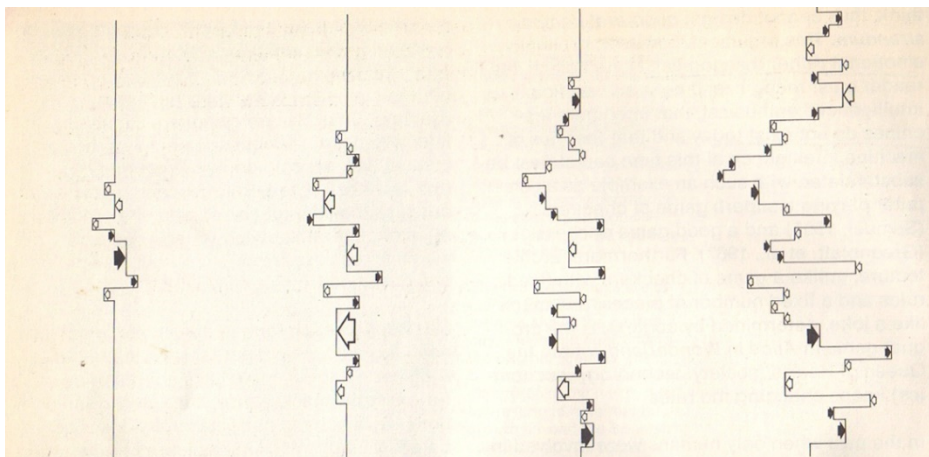

Figure 6. The diagram as a metaphor by Negroponte

Negroponte was keen to use new digital notation methods to help visualise movement and activity in the city. His diagram (Fig. 6) uses visual variables as a means of handling large amounts of information.

### 2.1. Visualisation



For Wayne McGregor's recent piece 'Atomos' (2013), visual artists OpenEndedGroup developed a system to choreograph dancers' movements by screening them a visualisation of biometric data such that the dancers movements are a never repeated response to a related input – a constant and continuous creative process.

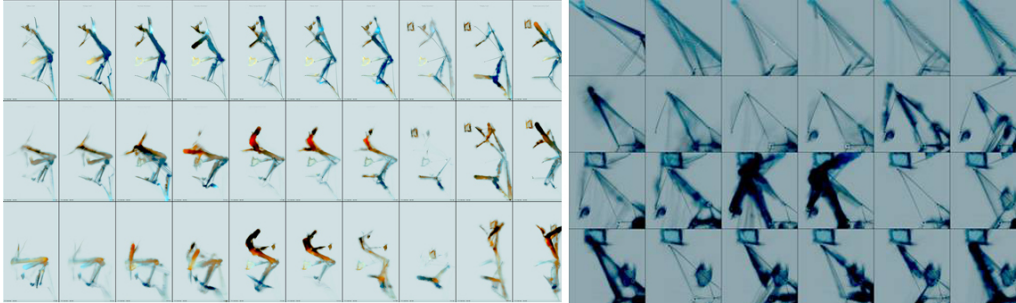

Figure 7. 'Becoming' for 'ATOMOS' (2013)

## 2.2 Scaling

The above project enabled designers and choreographers to use an external variable to conduct a dance, rather than didactic notation. It frees the system from scale.



Fig. 8. 'Moving Target' (1996)

In *Moving Target* (1996, Figure 8), Diller + Scofidio & Frédéric Flamand, the challenge of 'scaling' and 'de-scaling' can be seen. Dancers and projections simultaneously occupy the arena also combining a reflected stage and projected dancers. Encounters between the real dancer's movement and the virtually reflected bodies are merged, while dancer's movements are governed by moving projection targets. Several technologies support an optimised scenography creating deception and dynamic responses.

Here technology turns space into an instrument to be played in a dynamic act - the *quality* of body movement is reshaped each time. Ultimately, they become observable objects as well as being independent from the original scale. Collard (2015) explains "By refusing stable reference points, it shifts our attention from artistic product to signifying process". The evidence of this piece shows how precision is perceived in different individuals.

## 2.3 Timeframing

A timeline offers a way to recognise periodicity within a score. The digital notation allows information on the score to recur freely, but allocates it within a dynamic framework using a set of rules. For Forsythe's piece *One Flat Thing* (2013), 'synchronous objects' (Fig. 9) was developed

## A dance of circular feedback processes in constructing spatial notion

with digital artists at Ohio State University. Codes give hierarchy and individual tasks. It frees dancer's to produce individual movement whilst attention can still be paid to the collective movement. Grove (2012) describes how these scores "do not transcribe movement, but call attention to how ideas produce movement and how movement occasions ideas".

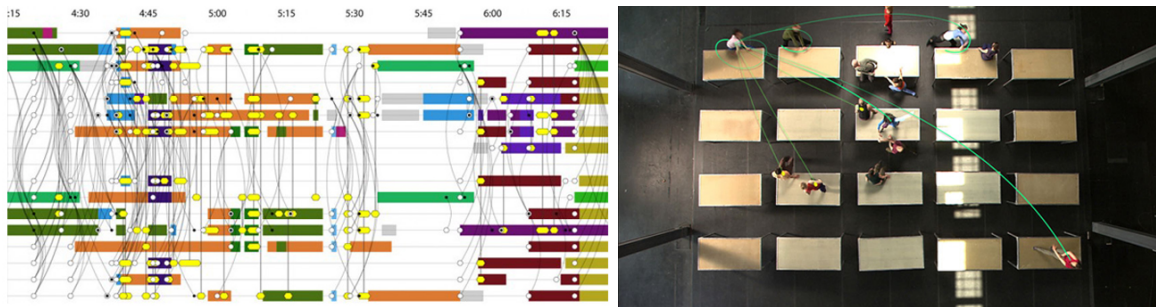

Figure 9. synchronous Objects for 'ONE FLAT THING' (2013)

The timeline can be used in architecture as a tool for organising and situating conditions of changing environments. Kamvasinou (2010) demonstrates this in her 'Stansted project' (Fig. 10). Notation focuses on the experience of space, rather than object. Information of a site is more precisely identified as transitional factors occurring in time. Time based interfaces offer routes for individuals. Digital processes help manage this plethora of data in future design processes.

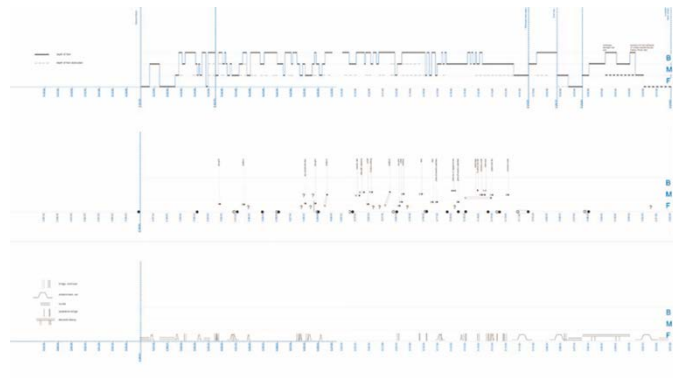

Fig. 10. Timeline notation for 'Stansted project' (2010)

### 3. Performance driven fabrication generates space and form.

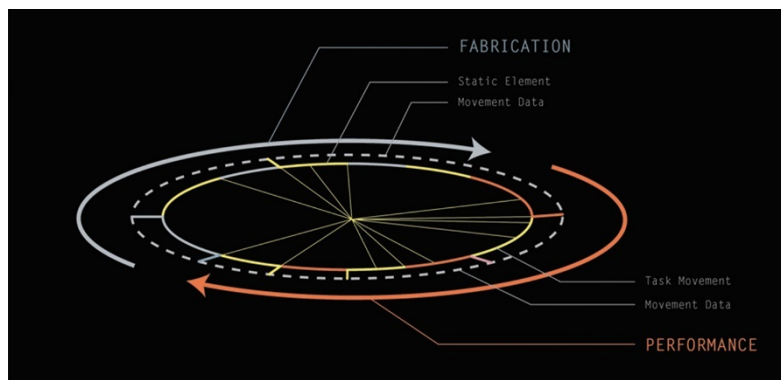

Figure 11. Performance-driven Fabrication Scenario

In our research project "*Fabricating Performance*" developed at the Interactive Architecture Lab, Bartlett, UCL, digital scores are in dialogue with a fabrication system (Fig. 11). An iterative

feedback loop bridging analogue and digital processes, dance, motion capture, digital notation and robotic construction.

'Improvised movement', 'Rule based movement' and 'pre-choreographed movement' (Fig. 12) were examined using an OptiTrack motion capture system. What emerged, was an 'Annotative' activity which offered dancers an opportunity to express a notational system spatially.

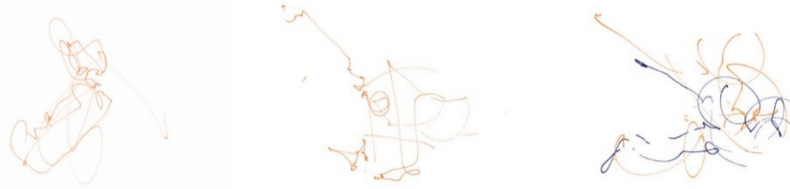

Fig. 12. Data from Improvised, Rule based and pre-choreographed movement.

### 3.2 Data driven fabrications

Aluminium tubing was chosen as the materialisation of the notation. (Fig. 13) for its easy of bending while maintaining structural capabilities. Body movements were rationalised into 'toolpaths' for robotic bending with an applied set of rules that included the constraints of material.

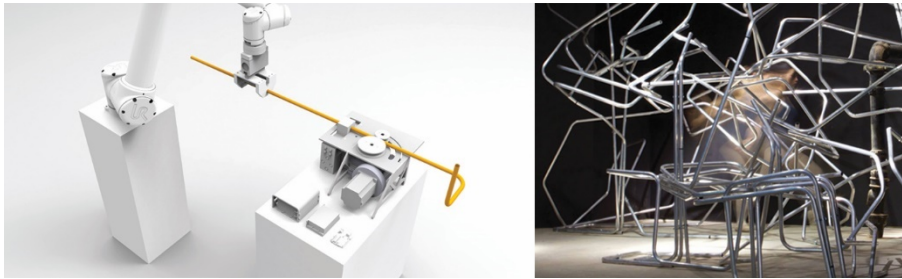

Figure 13. UR 10 Robot and and bespoke end effectors / Fabricating performance

Rationalization of performance data enables the translation of movement into assemblies of discrete gestures. Space becomes an aggregation of moments of communication. Within the repetition and transfer, rhythms are created in which inhabitants can perform and occupy building areas of density and flight.

These iterative qualities of construction challenge the audience as later invited inhabitants to sense and touch the intent of a performance that emerges within the complexity of movement. During this process, the autonomy of such a system draws attention to where the expression of a performers' thinking process is focused (Groves, R., et al., 2007).

This is the cycle of creativity, which happens in the translations and interdependency between attention, thoughts and approaches. Sharing what is happening in the procedures creates an invitation for the information to be kept and renewed. These procedures gradually grow in form, ultimately making the invisible 'quality of movement', visible. The notions of repetition, rhythm and patterns designate vital potential to qualify movement in space and raise questions of how these qualitative segments (movement) can be articulated in quantitative (physical) matter.

## A dance of circular feedback processes in constructing spatial notion

### Conclusion

Using movement to create a designed performance and designed space of performance synchronously, demonstrates how interactive drawing notation might become a more dynamic communication and construction tool. Our circular design process, occurs within changing conditions based on ongoing inhabitant behaviour. The work therefore contributes to both discourse on drawing in the age of digital and interactive representation and in practices exploring the interrelations between body, movement and spatial design.

### References

- Collard, C.: 2015, *Moving or Morphing Target? Hypermedial Hybrids, Diller + Scofidio-style*, Body, Space, and Technology 14, Brunel University.
- Gage, S.:2007, *Constructing the User*, John Wiley & Sons, Ltd., Wiley InterScience, 313-322.
- Groves, R., et al.: 2007, Talking about Scores:William Forsythe's Vision for a New Form of 'Dance Literature', Knowledge in Motion, TanzSctipte, 91-100.
- Kamvasinou, K.: 2010, *Notation timelines and the aesthetics of disappearance*, The Journal of Architecture, 15:4, 397-423.
- Negroponte, N.: 1970, *The Architecture Machine: Toward a More Human Environment*, Cambridge: MIT Press.
- Tschumi, B. (1996), *Architecture and Disjunction*, The MIT Press.
- Weinstein, B.: 2013, *Performing Architectures: Closed and open logics of mutable scenes*, Performing Research: A Journal of the Performing arts, 18:3, 161-168



## A Robotics of Trivial Mechanisms:

### The Pirouetting Picket Fence

*From Trivial Embodiment to Complex Behaviours*

**Abdulbari Kutbi**

*The University for the Creative Arts*

*Canterbury, United Kingdom*

*abdulbari@kutbi.co.uk*

**Abstract:** Distributed computation has been a theme in robotics since the work of Brooks (1999) concerning alternative methods for organising sensing and actuation in robots, what was dubbed 'behaviour based robotics'. This approach generally utilized digital sensing and actuation to recall behavioural decisions often organised as layers of control in variously distributed manners (almost always in a virtual way). The following paper presents an application of distributed computation through reactive, non-digital, physically embodied behaviours. The reactive behaviours are utilized to generate meaningful actions on and in the real world. The work addresses Rodney Brooks' behaviour-based robotics (1999) and Chandana Paul's 'Latent Morphological Computation' (2004); both having previously emphasized the capability of response data to generate computation through actions rather than virtual processes. The approach outlined achieves those aims by means of 'trivially' embodied mechanisms, designed as computational elements that, in combination, output navigational decisions within a simple, structured environment.

An experimental robot was built that links embodied sensing and reacting within an adaptive skeletal morphology. A series of experimental trials are recounted as having produced meaningful behaviours including changing configurative choreographies and navigational choices in relation to the environment. An analysis of these behaviours is used to argue that basic mechanical systems can be organised into colonies of computation generating nodes to accomplish direct behaviours.

**Keywords:** *Subsumption Architecture; Morphological Computation, Embodied Intelligence, Distributed Computation.*

## 1. Introduction

After the tradition of Brooks in behaviour based robotics, research into embodiment has evolved with a focus on virtual models more than experimental devices. This is due to the tendency to emphasize already established methods of research. This meant that there is little work on mechanical embodiment as a computational process. The author proposes that experimentation with physical embodiment yields some unexpected concepts and observations

## **A Robotics of Trivial Mechanisms: The Pirouetting Picket Fence**

that can then feedback into virtual models. The implication of this is an expansion of the possible approaches to solving computational problems.

Maturana & Varela (1991) first proposed the concept of 'structural coupling' as a description for the dynamic information relationship between agent and environment. Others sought to define and explore the possible contributions of an understanding of coupled interactions to applied robotics. Pfeifer (2007) cites "the reciprocal and dynamical coupling among brain (control), body, and environment." as something becoming increasingly important in designing robots. This research is an application of this concept of embodiment on a real world environment through an experimental device, demonstrating how radically embodied agents can contribute to solving basic computational problems through mechanisms of embodiment, structural coupling & layered control. Furthermore, the work is a speculation on possible solutions to spatial problems in the context of navigating and exploring a defined environment.

### **2. Approaches to Action**

There are two ways to think about control and action in an automated device, either through a centralised model, where the world is represented through sensor data and actions are evaluated and carried out on it (centralised control). Alternatively, control can be exerted through distributed actions where "the control system can be viewed as a system of agents each busy with their own solipsist world." (Brooks, 1999)

Brooks' work at MIT paved the way for a novel approach to AI (Artificial Intelligence), based on the idea that intelligence need not come from centralised control & representation. Brooks' work on distributed control systems showed how complex behaviours can emerge through interactions of agents connected through a physical or virtual structure. This "Subsumption Architecture" (Brooks, 1999) made critical use of organising behaviours in a layered hierarchy of constant loops with the world. At any one point the robots would be enacting the most basic level of actions, and more complex behaviours would emerge as their interaction with the world developed, using the world as a resource.

Brooks' Layered systems operate through organising reactive behaviours triggered by virtual sensors. To do this, behavioural elements are separated into modules within a layered architecture of lower and higher actions. In such systems the reactive behaviours are triggered through direct sensor-action loops. This approach dispenses with the need for centralised planning, verification of sensor data, control, and representation of a world on which behaviours are enacted. By removing the need for centralised representation and control, behaviours are enacted as simple reactive responses. This draws similarity with embodiment as it operates in biological organisms as explored by Pfeifer et al. (2007). Such qualities of embodiment have been described by Mataric (1997) as "relying on a direct coupling between sensors and actions and a fast feedback loop through the world."

This summarises how an understanding of the potential of the relationship between body and world can offer opportunities for intelligence to emerge. The remainder of the paper traces the construction of an experimental mobile robot that puts to the test a radical version of these

concepts, an application of distributed computation through reactive, non-digital, physically embodied behaviours. The embodied reactions are utilized to generate meaningful actions in the real world. This approach references McGreer's Passive Dynamic Walking (1990), Brooks' numerous behaviour-based robots (1999), Connell's colony architecture (1987) & Paul's Morphological Computation (2006), all of whom have previously emphasised mechanisms which prioritise the use of the body and the world as computational resources for action. The approach outlined achieves the aims of meaningful behaviours purely by means of 'trivially' embodied mechanisms, designed as computational elements that, in combination, output navigational decisions within a simple, structured environment.

## 2.1 A Hybrid Model

Thus, a combination of these systems was adapted to constructing the Pirouetting Picket Fence (Figure 1). The experimental robot utilised direct response mechanisms in a colony organisation to enact complex actions. Affordable & simple, these mechanisms rely on the construction of a body that has within it the potential to enact a specific range of responses to external stimuli. By doing so, it displaces the burden of reliability from virtual processes to physical processes, enabling us to focus on the design and craftsmanship of the body as a vehicle for 'mind' operations.

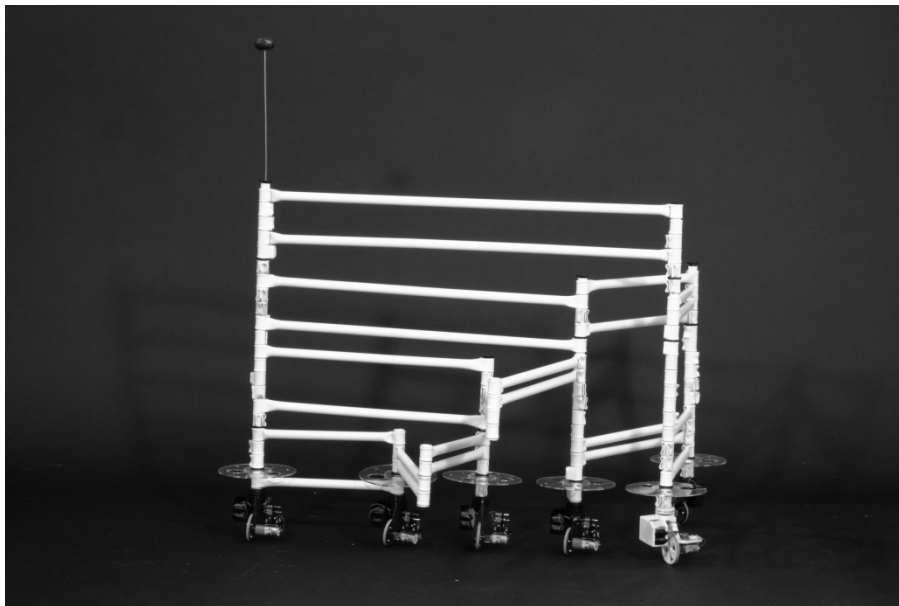

Figure 1. The Pirouetting Picket Fence

## 3. Physical Logic

### 3.1 A Mechanical Skeleton

An experimental robot was built that operates using the embodied reactions of an adaptive skeletal morphology composed of radial arms linked to each other through a pivot (figure 2). The morphology is derived from a parallelogram linkage system where one of the series of links is significantly larger than the rest, allowing the shape to overlap (figure 2). This was built from PVC tubing (electrical conduit tube, 20mm); the skeletal frame is lightweight, easily reconstructed and

## A Robotics of Trivial Mechanisms: The Pirouetting Picket Fence

provides high flexibility, a quality that emerged as vital in the performance of the robot. The components were made from 3 meter segments of PVC tubing, cut and moulded to basic forms by heating it up. These modules were then assembled in jigs (Figure 3) built to maintain the regularity and accuracy of the form.

The device is made up of four arms of varying lengths (300, 500, 700, 900mm) attached to a central point; linked together through dual linkages of 300mm lengths on average. This configuration allows the device to open up to a 270 degree circle when required, in practice this means an ability to change form in reaction to external forces.

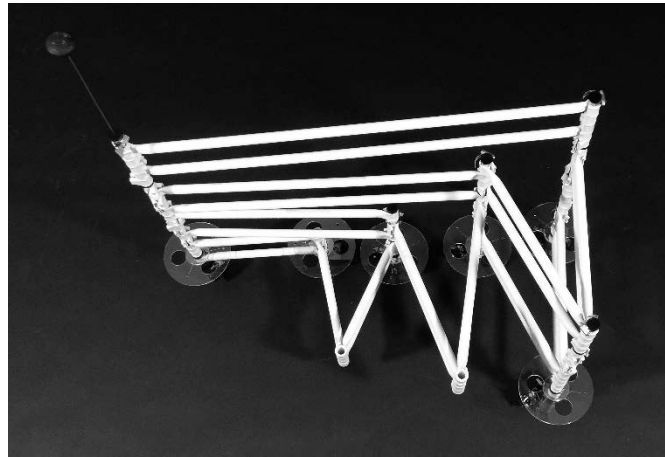

Figure 2. Robot Skeleton Configuration

### 3.2 Computational nodes

The powering component of the robot is its propulsion units, produced using three dimensional prototyping. The iterative process went through 25 variations of the module to arrive at a working prototype; each module contains a 24v DC motor powered by two 9v batteries (figure 4) wired in series to produce double the voltage, effectively 18v. A 70mm wheel is attached to each motor and offset from the centre point of the fixing, this replicates the motion of a castor wheel in reverse.

The functional logic of the nodes is based on a simple premise, collective vectors will follow a common trajectory based on forces exerted on the system, and this also relies on the level of resistance posed by a single agent (modulated by the power of the motor). In our case the system is very flexible and responds to even minor resistance.



Figure 3. Construction Jig Figure 4. Motorised Node

Therefore, the robots behaviours stem from the movement behaviour of the nodes, the lowest in the level hierarchy.

### 3.3 A behavioural Sequence

Level 0: The lowest level is of a single moving node, itself working against the noisy environment to locate an optimum trajectory.

Level 1: The second level is the colony behaviour of the nodes put together; they resolve their network behaviour against any forces to find a global trajectory.

Level 2: The second level is the choreography of the skeletal structure; it changes form in order to accommodate the collection of forces exerted by the interaction of the world and the colony agents.

The collective effect of this sequence (figure 5) of events is complex computational output produced through nothing more than a physical model of an algorithm.

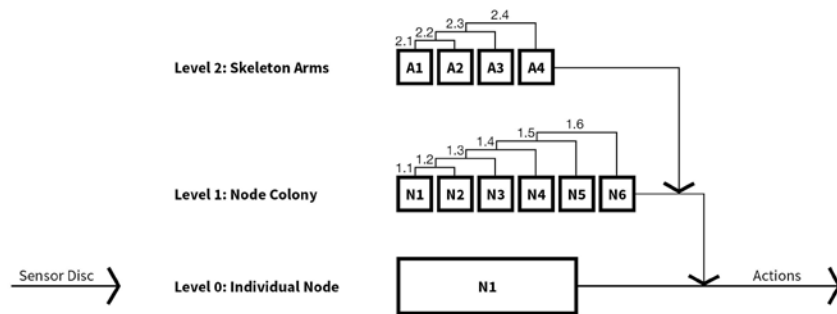

Figure 5. A Layered Behavioural Architecture (Abstracted from Brooks (1999))

## 4. Observations

A total of eighteen (18) hours of operation have been conducted as part of the project, some of those in a gallery setting as part of an exhibition in Conjunction with the Herbert Read Gallery at the University for the Creative Arts in Canterbury, the rest was done during the MA project. In all the instances the robot was limited by the number of battery hours available in the configuration and could only work for a maximum of approximately two to three hours constantly. The tests varied in goals, some presented a labyrinth to the robot, some presented a constricted space for navigating, and some presented a series of small spaces. The environment was always made up of a room with flat walls and cuboid shapes scattered around the room to frame smaller spaces for navigating. In the gallery setting the experiment included people interacting with the robots and nudging them in various directions as well as pushing them around the gallery and exploring their behaviours.

The early tests were focused on discovering how the robots move around and whether the expected behaviours would be recreated, the observed behaviours include:

- A. changing direction based on resistance inputs.
- B. Nodes pushing against each other forcing the choreography of the skeleton to change.

## **A Robotics of Trivial Mechanisms: The Pirouetting Picket Fence**

### C. Changing form in order to overcome obstacles.

Early trials proved the device able to change direction and to change form only when sufficient resistance forced it to do so, while overcoming obstacles was easily demonstrable. The second set of trials was conducted with an improved device and more robust nodes. Expecting longer operation, the robot continued to navigate its way out of tight corners and manage to reverse direction when the space no longer accommodated its form<sup>1</sup>.

With this in mind, the robot has observably demonstrated its ability to change configurative choreographies and to enact navigational choices in relation to the environment. The coupling relationship between the device and the environment is demonstrable most in those moments when it appears to make logical decisions about direction and size, where the decision capacity lies in that dynamic connectivity and interaction between body and world. Having observed this, we can state the following: basic mechanical systems can be organised into colonies of computation generating nodes to accomplish direct behaviours, the nature of the behaviours and their level of intelligence relies on the organisation of the mechanical nodes and their layered relationships.

## **5. Optimising Performance**

### 5.1 Colony behaviour

The issue that took the most time and effort to resolve was making the locomotive nodes operate robustly and as intended. A process of reverse engineering a castor wheel became increasingly subject to requirements of power consumption, operation time and output energy. Once this issue was resolved appropriately, the observed behaviour of the colony was surprisingly successful. As the prototypes had confirmed, the interactions of the nodes produced consistent navigation of obstacles.

### 5.2 Skeleton behaviour

In order to optimise the navigation behaviour of the robot the skeleton had to be engineered to allow for a number of processes to occur simultaneously. It needed to allow for each arm to rotate freely around the smaller arms. It needed to embody enough tolerance for the nodes to interact through its structure. It needed to balance out the weight of overall elements on every side to avoid toppling over. It needed to allow enough space for the linkages to open and close without causing a jam.

A digital simulation model was programmed in order to test the ideal lengths of the arms and the ideal lengths of the linkages, optimising them for all of these conditions (figures 6 and 7). A number of mock-ups were constructed and gradually tested, after which a successful configuration was chosen.

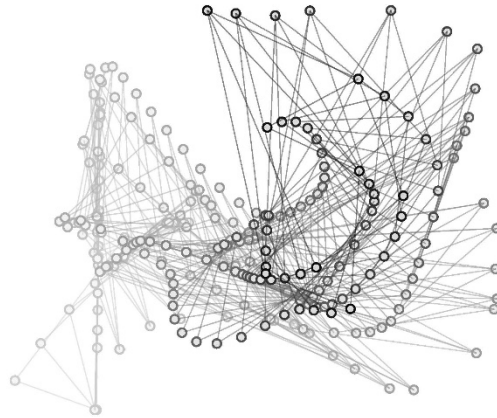

Figure 6. Virtual Simulation of the Robot's Morphology

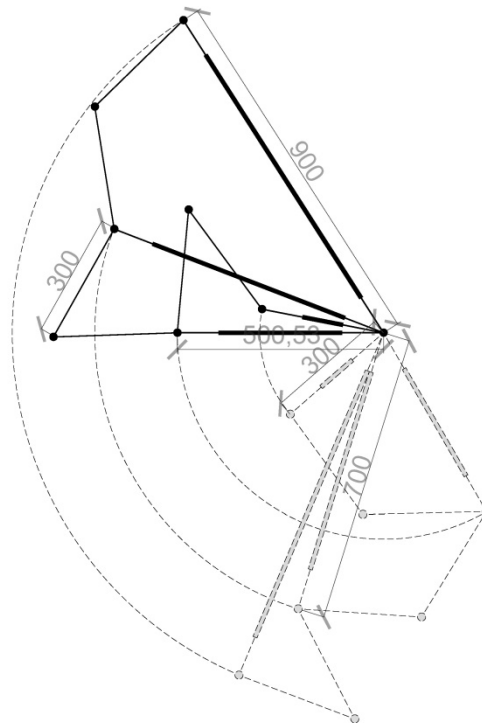

Figure 7. Skeleton Blueprint

## 6. Conclusion

This paper described an experimental mobile robot -*The Pirouetting Picket Fence*- constructed as a test for an entirely embodied behavioural system. The robots construction and design elaborated on the principles set forth by Brooks (1999) for distributed control systems and embodied robots. The robots functions were based on solving navigational problems in a real environment.

The tests recounted demonstrate the viability of the approach in the design and execution of complex behavioural systems in the domain of navigation and morphological transformation. More accurately, the node network abstracted from the device acts as an algorithmic tool for

## A Robotics of Trivial Mechanisms: The Pirouetting Picket Fence

solving domain-specific problems, in this case problems of navigation. The major outcomes of the work are the following in order of significance:

- How layered mechanical embodiment can generate meaningful actions in robotics.
- The significant role of morphology and dynamical coupling in mediating functional exchanges with the world.
- That combinatorial approaches are vital in pushing forward a study of embodiment and artificial intelligence.
- That real-world experiments are a significant driver of creativity and discovery in the field.

### 7. Future Work

The next stage in this work is to develop the network and the mode of interaction with the world to design the next version of a mobile robot. The work is contextualised as part of the broader field of art practice concerned with interactivity and animism. The author hopes that future projects emerging from this research will continue to generate insights into the emergent properties of systems. It is these insights that provide us a glimpse into what is possible.

### Endnotes

1. FILM: <https://vimeo.com/153281505>

### References

- Brooks, R. A., 1999. *Cambrian Intelligence: The Early History of the New AI*. London, England: The MIT Press.
- Chandana, P., 2004. Morphology and Computation. *Proceedings of the International Conference on the Simulation of Adaptive Behaviour*, pp. 33-38.
- Chandana, P., 2006. Morphological Computation: A basis for the analysis of morphology and control requirements. *Robotics and Autonomous Systems*, 54(8), pp. 619-630.
- Gage, S., 2001. The Wonder of Trivial Machines. *Systems Research and Behavioural Science* 23, pp. 771-778.
- Green, D. G., 1994. Emergent behaviour in Biological Systems. *Complexity international*, pp. 1-12.
- McGreer, T., 1990. Passive Dynamic Walking. *The International Journal Of Robotics Research*, April, 9(2), pp. 62-82.
- Pfeifer, R., Lungarella, M. & Iida, F., 2007. Self-organization, embodiment, and biologically inspired robotics.. *Science*, 318(5853), pp. 1088-1093..
- Quick, T., Dautenhahn, K., Nehaniv, C. L. & Roberts, G., 2000. The essence of embodiment: A framework for understanding and exploiting structural coupling between system and environment.. s.l., IOP INSTITUTE OF PHYSICS PUBLISHING LTD., pp. 649-660.
- Rosenblueth, A., Wiener, N. & Bigelow, J., 1943. Behaviour, Purpose and Teleology. *Philosophy of Science*, 10(1), pp. 18-24



# Interactive Architecture in The Digital Age- Parametric Design of an Open Source Responsive Solar Filter

**Maria Genevieve Bezzone**

*Polytechnic of Turin*

*Turin, Italy*

*m.genevieve.bezzone@gmail.com*

**Abstract:** Architecture has to become an active element in a world informed by data. To conceive interaction in architecture can enlarge benefits, also related to building lifespan, declined in adaptive perspective and combined with open source processes. The main scope of this paper is to present the development and evaluation of a responsive solar filter, capable to process solar radiation as inputs and return bespoke outputs to the user. Thanks to the application of an emergent design, the filter reaches swarm dynamics that allow self-organisation, strictly related to circumscribed inputs. Responsive origami shaped modules attempts to regulate the fluctuating luminance of daylight and to optimize daylight uniformity, shading and reflecting direct sunlight. This helps to avoid glare and enhance natural light benefits. Outputs are evaluated against a merely technical approach, in order to enlarge the relationship with the user. Parametric software is used to shape the component and to relate environmental variables, estimating results. The paper presents the analysis of a study case configuration in two opposite conditions of the year; the results show the incrementing quality of natural lighting distribution in the space, due to the fitness of a shaped user approach and a consonance with the context.

**Keywords:** *Parametric; Interaction; Responsive; Emergence; Daylight; Kinetic; Adaptive.*

## 1. Introduction

In the digital age, the continuous decoding of the reality leads to achieve a stream of data that could shape architecture as a living being, able to adapt itself and react to environmental stimuli. The developments of this research are directed to understand how architecture could behave, designed by data, and change according to the inputs received from both the environment and the user, improving the quality of the living space. Solar radiation is one of the main environmental variables that influence the quality of the space, potentially increasing health benefits, energy saving and light control (Lo Verso, 2006). Traditional shading devices provide a rigid and uniform response to the diversified facets of solar radiation, depleting the adherence to the context. The present paper focuses on the design of a solar filter, structured as a responsive surface that, constantly informed, is capable to give a local response to both external daylight conditions and inner functional demands. This allows shaping a bespoke ambient, that goes beyond a merely technical approach and aspires to e-motive architecture (Oosterhuis, 2013).

# Interactive Architecture in the Digital Age: Parametric Design of an Open Source Responsive Solar Filter

## 1.1 Bio-inspiration: emergent system and complex behaviour

The design of the filter is strongly inspired by nature. In natural system, the most of sensing and reactions are exclusively local; then, the product of global action is generated by the behaviour of the whole, which is much more complex than the behaviour of the single parts (Holland, 1998); an irreducible propriety: *emergence*. All natural systems involve movement or transformation to achieve adaptation and responsiveness, through emergence. Responsive and adaptive processes can be referred to a short time period- where the interaction with the context is controlled by movements- and to long periods, where responsive behaviour leads to the evolution of the subject, increased by cyclic transmission of information and feedbacks. In the first case, movements are reversible and generated by the interaction of structures, energy sources and sensors. In the tissue of the leaf, stomata regulate the respiration of the plant: light stimulates the opening and they close at night. Furthermore, chloroplasts on the leaf upper side regulate the sun radiation intensity, adapting the shape and the orientation in the daytime period. Macroscopic behaviour of the leaves also allows protecting the whole plant, avoiding or exploiting sun radiation, through orientation. The phototropism and thermotropism phenomena make leaves orientate in a parallel or orthogonal position, in order to regulate the exposure to direct sunlight (figure 1)

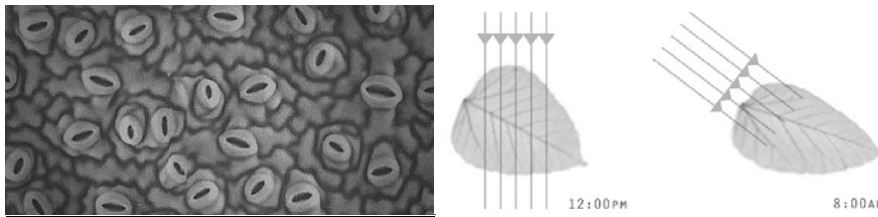

Figure 1. Without any central directing intelligence, collective behaviour of semi-autonomous subject generate adaptive processes. On the left: stomata constitute an emergent system regulating energy exchanges; on the right: leaves regulate sun radiation density in order to protect the entire plant.

Emergence propriety requires the recognition of architecture as a complex system that can interact with the context through self-organisation, instead of a fixed body.

The consolidation of the paradigm of emergence, transposed into architecture, is combined with the logic of industrial production, which demands that we recognise that buildings have a life span. Throughout their life, buildings have to maintain complex energy and material system: a result of the continuous interaction with the context. This concept entails a parallel vision in the project, between collective intelligence phenomena in nature and co-adaptation of buildings to human and society's needs (figure 2).

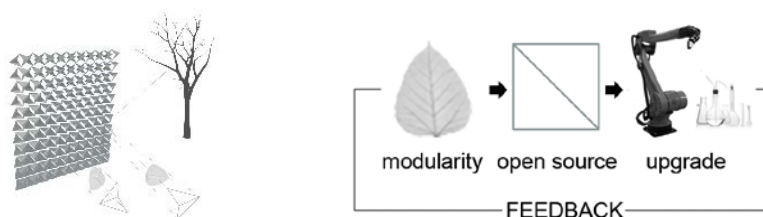

Figure 2. Concept of the project- implies that the filter have to be structured as modular system in order to adapt and upgrade endlessly.

## 2. Method

### 2.1 Design methodology

As structured behaviour emerges from the repetition and interaction of simple rules (Weinstock, 2004), the case study surface is divided into several modules, capable to adapt to different radiation density. Therefore, each single module produces a local response, according both to its position on the surface and light stimuli.

First step consists into produce an element capable to manage sun radiation and the second one provides to populate a case-study surface, in order to generate a complex reaction to sun radiation variables (figure 3).

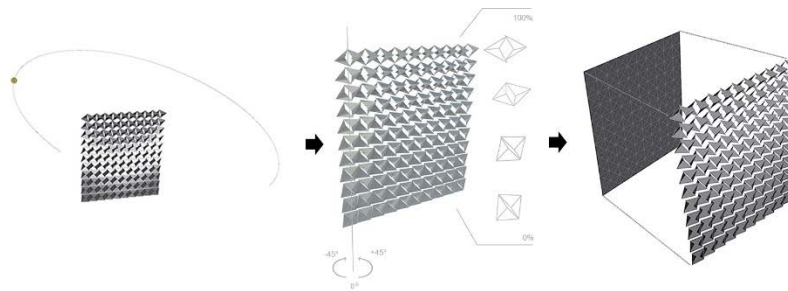

Figure 3. The modules rotate on vertical axis, according to the solar azimuth angle, while they open and close, to enhance illumination, reflecting and shading sunrays.

#### 2.1.1 Responsive component design

Sun radiation has to be considered as a sum of different variables: the light, the infrared component and energy; thus, the reaction of the architecture cannot be reduce to a static, univocal response.

Each surface module can close shading the sun radiation or open reflecting and diffuse the light in the inner space. To intercept sunrays, modules can rotate on horizontal axis of  $+45^\circ$  and  $-45^\circ$ , according to the solar azimuth angle and the constraints of the physical structure (figure 4). Furthermore, the opening and closing of each module are regulated by the sun altitude and by the amount of required illumination falling into the ambient (figure 5).

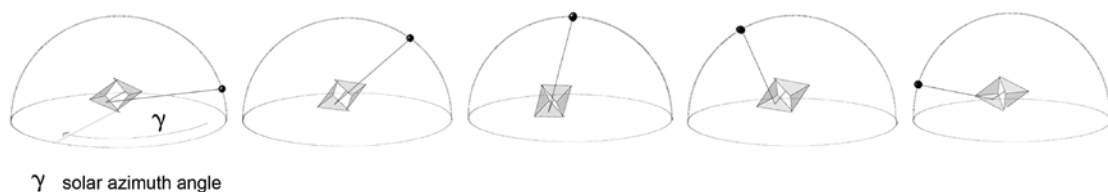

Figure 4. The modules rotate on vertical axis, according to the solar azimuth angle, while open and close to better reflect the sunrays.

## Interactive Architecture in the Digital Age: Parametric Design of an Open Source Responsive Solar Filter

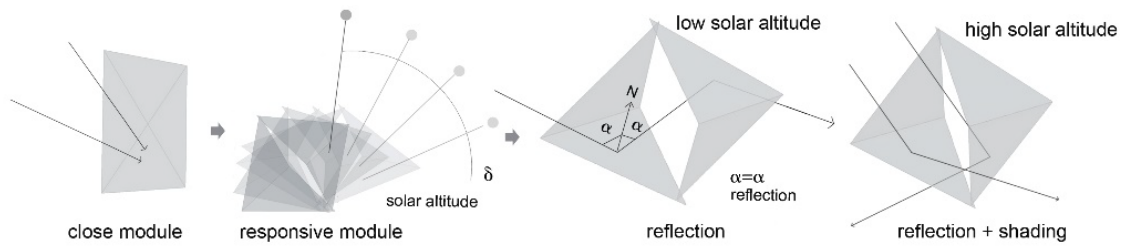

Figure 5. Each surface module unfolds to fit better to sun radiation stimuli. It can partially shadow and reflect the light, orienting according to the sun altitude angle.

Therefore, origami shaped quadrangular modules provides to give a dynamic outline, capable to intercept sunrays and reflect them into the ambient, decreasing direct sun radiation when the solar altitude is maximum and increasing the quality by diffuse lighting with low solar altitude, decreasing risk of glare (figure 11).

### 2.1.2 Implementation with the prototype

In order to start a feedback cyclic process with the physical shape, one single module has been built as a responsive prototype, using Arduino and connecting it to the main model with the Grasshopper plugin Firefly. This procedure helps collect and transmit sensible data from the reality to virtual interface. The movement of the module is related to the variation of illuminance in the real ambient (figure 6).

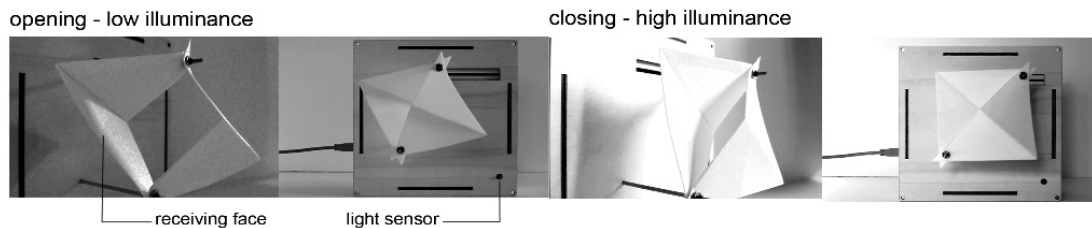

Figure 6. Opening and closing movements according to the sun radiance density, evaluated in lux.

### 2.2 Advanced algorithm

Even though the algorithm works with environmental variables, the filter has also to fit user comfort parameters. Therefore, the whole behaviour of the filter has been related also to user's parameters, coding a local interaction based on the position of the user in the space.

When solar altitude is low, the responsive filter eliminate glare risk, enhancing illuminance. Natural light is redirected in the space according to different position of the module on the filter: upper side modules diffuse the sunrays in direction of the ceiling- that generally has a high reflection coefficient, low positioned modules diffuses the light over eyes position, in order to reduce glare risk (figure 7).

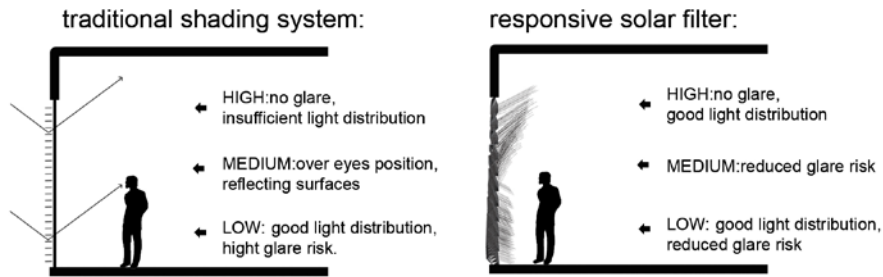

Figure 7. Left: scheme of advantages and risks of traditional shading system. Right: raytracing analysis of solar filter. South-East oriented study case room. Winter solstice 21th December, h. 4 p.m.

In presence of high solar altitude, the responsive filter shades direct sunlight and partially reflect it into the space, in order to decrease overheating without compromising illuminance (figure 8).

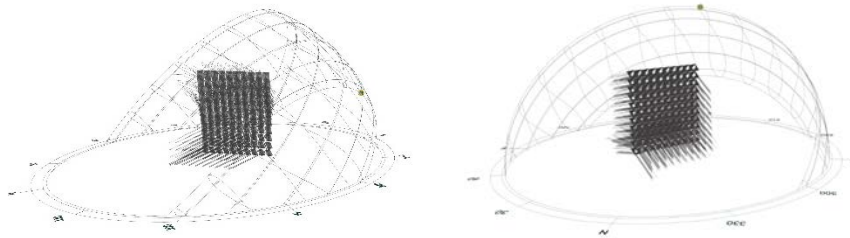

Figure 8. Left: raytracing analysis Winter solstice 4:00 p.m. Right: raytracing analysis Summer solstice 1:00 p.m. South-East oriented study case room.

### 3. Parametric simulation and results

To develop the algorithm and analyse the model, Grasshopper Rhinoceros' plugin was used, with both Diva and Ladybug parametric analysis tools. External variables considered are solar radiation and sun position during summer and winter solstices, at the location of Turin, Italy. The study case filter is South-East oriented. Study case room dimensions are 2 x 3 m, 3 m high. Reflectance parameters (table 1) are used to run illuminance analysis. Raytracing analysis (figure 9) shows the behaviour of the solar filter to capture and reflect sunlight, enhancing illuminance.

**Interactive Architecture in the Digital Age:  
Parametric Design of an Open Source Responsive Solar Filter**

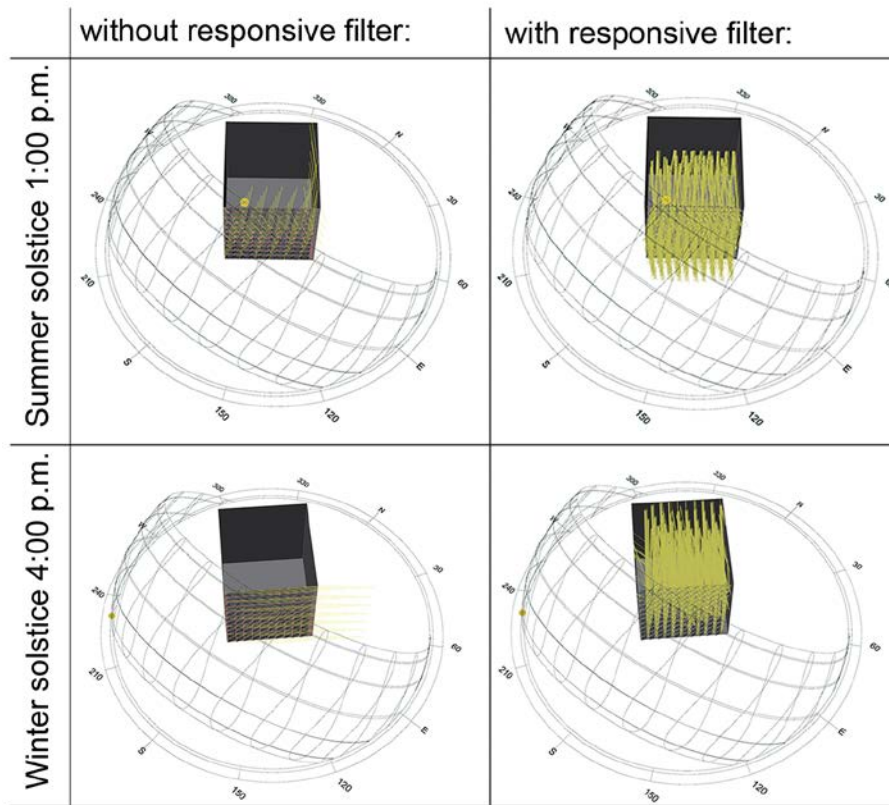

Figure 9. Raytracing analysis in winter and summer solstice, with and without responsive solar filter.

| Indoor space parameters- reflectance |         |       |                   |
|--------------------------------------|---------|-------|-------------------|
| walls                                | ceiling | floor | responsive filter |
| 50%                                  | 80%     | 20%   | Metal diffuse     |

Table 1. Indoor parameters used in illuminance analysis with Diva for Rhinoceros.

While the range of results cannot be considered relevant in term of comfort parameters, because of the limits of the model, the general illuminance standards are respected. The comparison between data shows the aptitude of the filter to shade and reflect sunlight, without compromising illuminance increase (figure 10).

Nevertheless, the uniformity of the illuminance is satisfied. According to standards of ISO 8995- Lighting of indoor work places, the illuminance shall change gradually.



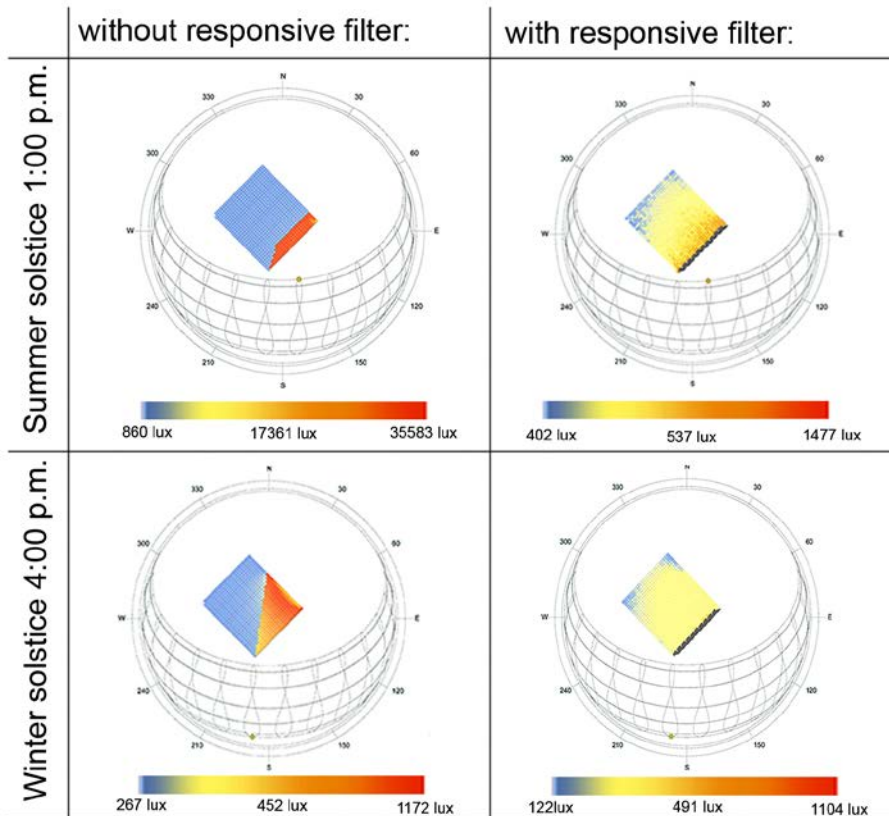

Figure 10. Illuminance analysis- with CIE clear sky, during Summer and Winter solstices: comparison between a model without and with responsive filter.

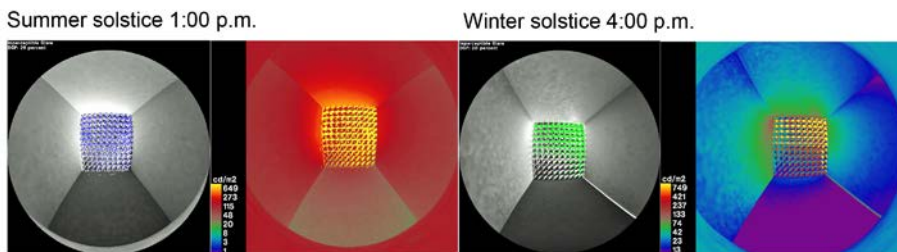

Figure 11. Glare analysis and luminance distribution of the study case room with responsive solar filter. Summer solstice: DGP 26% - imperceptible glare. Winter solstice: 20% - imperceptible glare.

#### 4. Conclusions and discussions

The interactive solar filter has inherent advantages: optimised indoor illumination quality based on user shaped approach. The increment of natural lighting increases psychophysiological advantages, while it helps saving energy, decreasing the use of artificial lighting and air conditioned in summer.

Furthermore, automated interaction with the user is helpful in a perspective that goes beyond a mere functionalism and embraces the existenzmaximum.

However, the project has some limits: dynamical analysis of fluctuating daylight is time consuming, while the degree of accuracy has to be improved. Automated component may have complex electromechanical systems, energivorous and with high maintenance costs. This aspect

# **Interactive Architecture in the Digital Age: Parametric Design of an Open Source Responsive Solar Filter**

could be solved in future developments of the research, integrating responsive material design in the project.

## **Acknowledgements**

The author acknowledges the support of all participants in the project: Pedro Miguel Gomes Januário- from Faculdade de Arquitectura UT in Lisbon; Roberto Pagani and Giacomo Chiesa- both from Department of Architecture and Design, Polytechnic of Turin; Attilio Nebuloni and Giorgio Vignati- both from Department of Design, Polytechnic of Milan.

## **References**

- Aghemo, C. and Lo Verso, V.M.: 2003, Guida alla Progettazione dell'Illuminazione Naturale, AIDI.
- Bing-Yu, C., Jan, K., Tong-Yee, L., and Ming, C.L.: 2011, Interactive Design of Planar Curved Folding by Reflection, Pacific Graphics.
- De Carlo, G.:2013, L'Architettura della Partecipazione, Quodlibet.
- Hensel, M., Menges, A. and Weinstock, M.:2004, Emergence in Architecture, in Architectural Design Emergence: Morphogenetic Design Strategies, Volume 74, Issue 3, Wiley-Academy, 6-9.
- Hensel, M., Menges, A. and Weinstock, M.:2010, Emergent Technologies and Design, Towards a Biological Paradigm for Architecture, Routledge.
- Lakhtakia, A. and Martin- Palma, R.J.: 2013, Engineered Biomimicry; Elsevier.
- Oosterhuis, K.: 2013, Hyperbodies: Towards an E-Motive Architecture, Birkhäuser.
- Park, J.J., Dave, B.:2013, Bio-inspired Responsive Façade, in: 2nd Central European Symposium on Building Physics.
- Schropfer, T.:2011, Material Design: Informing Architecture by Materiality, Birkhäuser.
- Tucci, F.: 2008, Tecnologia e Natura: gli Insegnamenti del Mondo Naturale per il Progetto dell'Architettura Bioclimatica; Alinea.
- Varendorff, A., Garcia-Hansen, V.:2012, Building Envelope: Performance Optimisation Processes for a Daylight Responsive Architecture, in 28th Conference, Opportunities, Limits & Needs Towards an Environmentally Responsible Architecture.
- Weinstock, M. Metabolism and Morphology, in Architectural Design Versatility and Vicissitude, Volume 78, Issue 2, Wiley-Academy, 26-33.
- Weinstock, M.:2004, Morphogenesis and the Mathematics of Emergence, Volume 74, Issue 3, Wiley-Academy, 10-17.



**Jessica In**

*The Bartlett, UCL  
London, UK  
j.in@ucl.ac.uk*

**Chee Kit Lai**

*The Bartlett, UCL  
London, UK  
chee.lai@ucl.ac.uk*

**Abstract:** This paper examines how interactivity allows for the exploration of culturally specific relationships, informing spatial and performative narratives of architecture within the authors' undergraduate design studio *Unit 9* at the Bartlett School of Architecture.

**Keywords:** *Architectural education; Physical Computing; Performance; Interaction Design.*

## **Introduction**

Architecture concerned only with the physical and material is analogous to ubiquitous computing being solely about sensing and responding – i.e. a reductive view of both disciplines and a missed opportunity for both to explore richness and layered meaning in our environments. This traditional balance, between physical and immaterial, between pure utility and constructed affect, provides a dynamic foundation for an architect's cultural explorations. How best to explore interaction and the immaterial in architecture? In addition to more conventional methods, our teaching practice utilizes interactivity - here defined as interaction with computers through physical computing, digital fabrication, computation and augmented or virtual reality - as an exploratory mechanism to study relationships between human/non-human entities. This paper introduces several themes of enquiry that have emerged from our teaching practice and puts forward the potential for this teaching methodology to deepen students' insights and explorations.

## **Responding to Complexity**

Cedric Price in conversation with Richard Goodwin (1979) expressed an interest in responsive architecture to respond to appetites rather than problems, while simultaneously refusing to define the appetites. For Price, architecture has to be very responsive, but rather loose. His methodology is responsive to cultural, social and technological agendas rather than to problems (Hardingham, 2012), and we suggest the looseness is to recognize the danger of generalising our environments into types as if they were finite, discrete categories. Our environments are the expression of a complex and continually shifting network of evolving parts (the physical-material), and the qualities of our cities, architecture and environments are sustained only by virtue of the relationships between these parts (the intangible-immaterial).

## **Interactivity and performance in the exploration of architectural narratives.**

The idea of an Architecture neither explicitly prescribed nor fixed, but arising out of the interactions between its constituent parts and its particular context is of course not new. [Scripted] space is inherited and is always attached to geographies histories and policies (Diller, in Hann 2012), and architecture is in a constant state of construction and reconstruction, [a] co-production of the social and technical (Latour).

Tschumi's ideas of Architecture as both a space and about what happens in that space, and that architecture can generate interaction (Hardingham, 2012), is a key thesis that underpins the thinking of *Unit 9*. We approach the development of this thinking in our teaching practice through two methods – the investigation of the epistemic function of drawing, and design exploration through interactivity. This paper focuses on primarily on the latter but also touches upon how the former, a classic architectural technique, can be reinterpreted in the current technological context.

### **A Hyper Type methodology for architectural narrative**

A strategy for how a student of architecture might begin to understand the complexity of immaterial relationships could begin by identification through exaggeration, or hyper (“over”, in Greek) categorisation (type). A common technique in speculative literary fiction, this method of heightened awareness allows for temporary detachment of any ‘reality’ that might otherwise hinder conceptual development in the early stages of design exploration. In the same way that the ‘novel proper’ lays claim to a certain kind of truth (Atwood 2011), a hyper-type exploration, no matter how seemingly exaggerated, explores core interactions and relationships that are fundamentally relevant to the current cultural, socio-political context.

### **Emerging hyper-types from a Research by Design methodology**

We identify five themes that have emerged from our teaching practice and will be discussed through the work presented in the paper: 1: Human x Human; 2: Body x Machine; 3: Human x Matter; 4: Event x Performance; 5: Urban x Boundary.

#### **Human x Human**

The following three projects examine interpersonal relationships between one or more human entities. Claudia Walton's '*The Path to Social Discomfort*' explores the fundamental role of eye contact in human social interaction and the difference in cultural communication in the impression of the direct gaze. Matthew Taylor examines dating interaction in the age of digital monitoring through an interactive table that ‘scores’ the couple's compatibility. Freddie Hong's Capoeira game reinterprets players' interaction into gestures and moves of *Ginga*, a fundamental movement of the Brazilian dance-marital art.

All three projects require participation with a physical device embedded with simple sensing elements, which reads one or several inputs and reinterprets it into an output, which then provides feedback and influences the participants' interaction. Walton uses eye-tracking software to measure and create a ‘drawing of discomfort’, projected back at the participants in real time; Hong

uses a light sensor to establish the 'grip' that each player has that affects the balance and speed of the resulting dance; Taylor uses pressure pads under the table seats and teapots to evaluate participation, as well as the skin conductance response between his daters to create music. Hong utilises two photocells embedded within the ends of the player's grips to control the speed and direction of the servo motors that drive the device mechanisms.

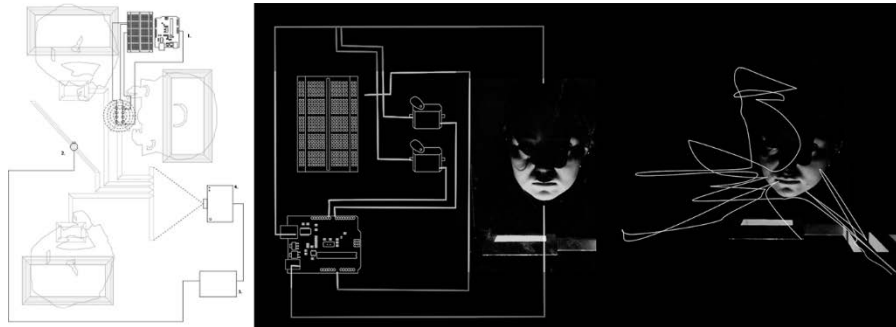

Figure 2, Physical setup diagram (left), and video stills from 'The Path to Social Discomfort', Claudia Walton Y2 2015-16. [vimeo.com/DesignUnit9/ClaudiaWalton001](https://vimeo.com/DesignUnit9/ClaudiaWalton001)

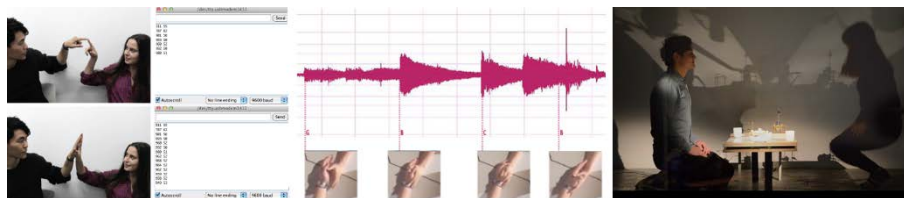

Figure 2, Monitoring physical contact levels (left) and translating contact to sound (middle), and video still (right), from 'Interactive Dating', Matt Taylor Y2 2014-15. [vimeo.com/DesignUnit9/MatthewTaylor001](https://vimeo.com/DesignUnit9/MatthewTaylor001)

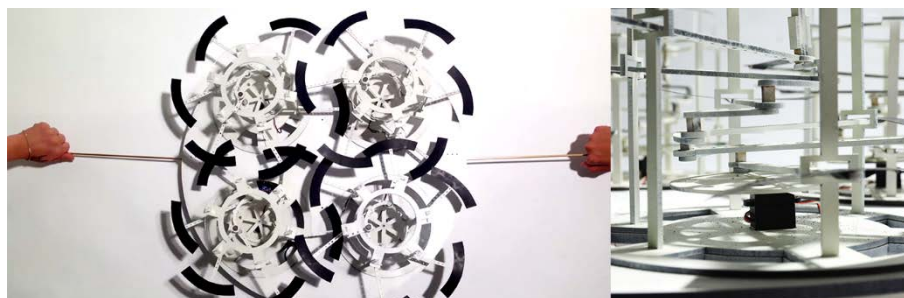

Figure 3, Video still of game interaction (left); game mechanism (right). 'Capoeira Performing Device' Freddie Hong Y2 2013-14. [vimeo.com/DesignUnit9/FreddieHong001](https://vimeo.com/DesignUnit9/FreddieHong001)

## Body x Machine

The following three projects examine and redefine a human techno-identity through a machine. Thomas Chu's 'Hidden Beauty, Dressing Device' deconstructs the dressing rituals of samurai and the hidden Yakuza culture of full body tattoos, and re-clothes the body through 3d scanning and 3d printing UV ink. Inspired by the ancient Japanese knot-tying technique *Shibari* and erotic bondage *Kinbaku*, Achilleas Papakyriakou's project 'Turn Me On' reconsiders the body as a landscape for voyeuristic spectacle. George Proud's 'Secret 3D Tinder Vending Machine'

## Interactivity and performance in the exploration of architectural narratives.

imagines the latest edition of Tinder for Tokyo where users can check out potential date profiles in a virtual vending machine.

All three projects involve the submission of the body before processing and reconstructing its identity in different ways. Both Chu and Proud begin by digitizing the body with a 3d scanner. Chu redraws a UV ink tattoo directly to the scanned arm with a mechanized robotic arm, while Proud recreates your dating profile in a virtual dimension through the Oculus Rift. Papakyriakou captures the body not with a scanned pointcloud but directly with an interactive prosthesis, embedded with photocells by the voyeur through touch, which activates valves programmed to release soft puffs of air while others release frost for pleasure/pain.

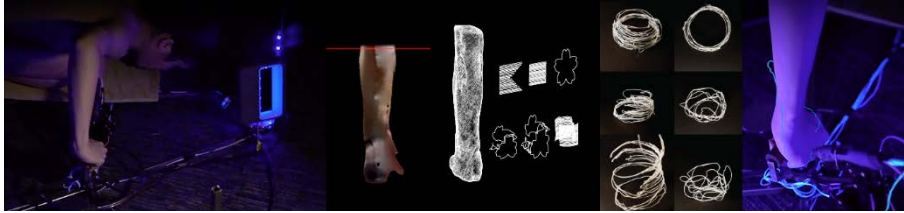

Figure 4 (L-R): Arm scanning; processing of mesh and 'tattoo' toolpaths; test 3d pen plastic prints; 3d pen 'tattooing/dressing' the arm with UV ink. *'Hidden Beauty, Dressing Device'*, Thomas Chu Y2 2015-16.

[vimeo.com/DesignUnit9/ThomasChu001](https://vimeo.com/DesignUnit9/ThomasChu001)

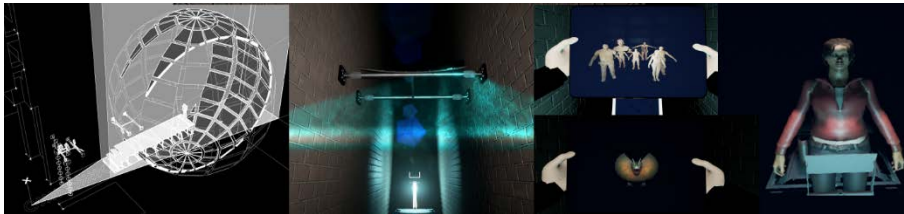

Figure 5 (L-R): Concept Drawing defining physical and virtual spaces; virtual torii gate frames the entrance to the vending machine; Selection of virtual Tinder profiles. *'Secret 3D Tinder Vending Machine'*, George Proud Y3 2014-15.

[vimeo.com/DesignUnit9/GeorgeProud001](https://vimeo.com/DesignUnit9/GeorgeProud001)

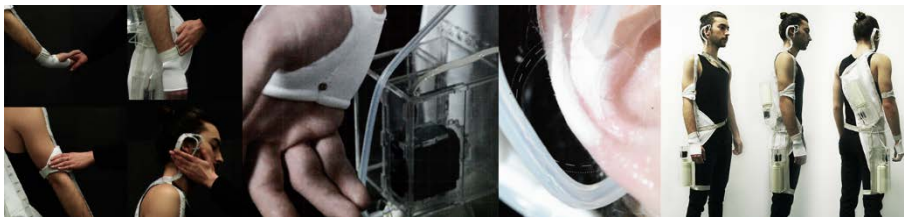

Figure 6 (L-R): Location of photocells in the palm of the hand, the arm, the hip and the neck; Video stills showing rack and pinion mechanism and frozen air on the ear; Device as worn. *'Turn Me On'*, Achilleas Papakyriakou Y2 2014-15.

[vimeo.com/DesignUnit9/AchilleasPapakyriakou001](https://vimeo.com/DesignUnit9/AchilleasPapakyriakou001)

## Human x Matter

The next three projects are examples of work that use light, water or energy to explore an ephemeral relationship. In *'The Transition of Energy'*, Isaac Simpson investigates three parts of Japanese calligraphy – *wabi-sabi*, *sumi* ink, and brush movement - to capture body movement into expressive drawings that capture glitches and mistakes. In Aya Ataya's *'Digital Purification'* the gestures of Japanese Shinto are reinterpreted through a digital light painting device, creating temple memento keepsakes captured through long exposure photographs. Roger Tung's

Interactive Time Fountain, inspired by the traditional Japanese garden cistern *Shishi-Odoshi*, uses water shadows to measure and seemingly control time.

All three projects use motion capture and/or gesture recognition - Simpson and Ataya utilise the Kinect skeleton to capture and translate ritual gestures, while Tung uses an IR sensor to detect proximity. Simpson aggregates three points of movement (head, torso and hand) into a drawing machine driven by three servo motors; Ataya programs an LED strip to move across, up and down a set of rack-pinion rails, reflecting the light through a rotating prism to capture the gestures as voids in the resulting light surfaces. Tung applies the stroboscopic effect to the noncyclical motion of dripping water to effectively stop, slow and reverse the motion of water droplets.

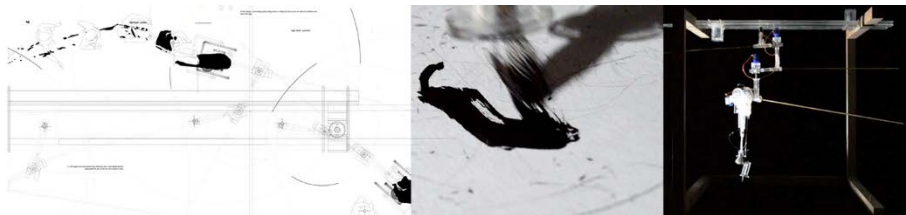

Figure 7 (L-R): Concept Drawing; Video still showing the drawing device in movement; Drawing apparatus. 'The Translation of Energy', Isaac Simpson, Y2 2014-15. [vimeo.com/DesignUnit9/IsaacSimpson001](https://vimeo.com/DesignUnit9/IsaacSimpson001)

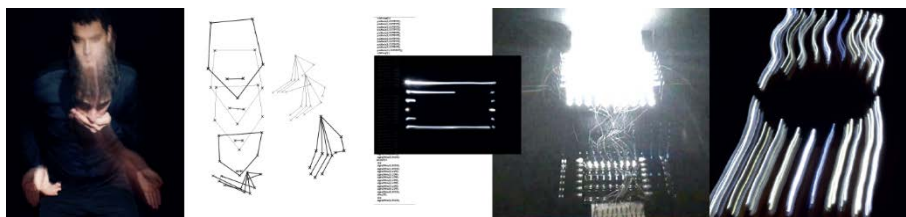

Figure 8 (L-R): Shinto Gesture + Kinect capture; Code sample test for light voids; Video still showing prism movement; resulting light painting. 'Digital Purification' Aya Ataya, Y2 2015-16. [vimeo.com/DesignUnit9/AyaAtaya001](https://vimeo.com/DesignUnit9/AyaAtaya001)

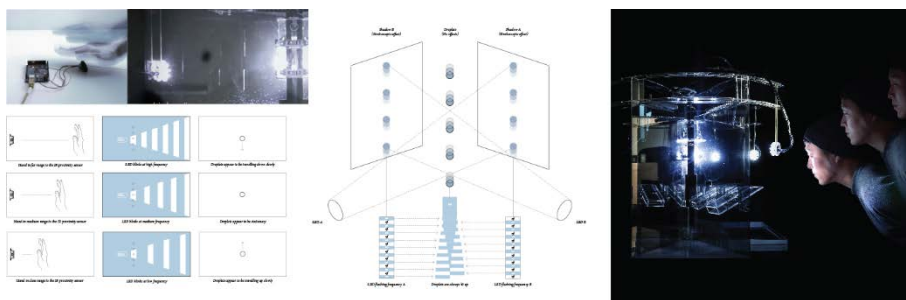

Figure 9 (L-R): IR sensor links proximity to LED blinking rate; LED frequency synchronization diagram to create two stroboscopic effects in the water drop shadows; Video still of the device. 'Interactive Time Fountain', Roger Tung Y2 2015-16. [vimeo.com/DesignUnit9/RogerTung002](https://vimeo.com/DesignUnit9/RogerTung002)

## Event x Performance

The following projects illustrate a performance or event re-interpreted through an interactive device. Amy Begg's *Courtship and Seduction* analyses the dance of courtship displayed by Shanghai Mitten Crabs into a mechanised speculative building component. Gary



## Interactivity and performance in the exploration of architectural narratives.

Edwards' *London Olympic Twitter Feed* responds to the frequency of specific hashtags during the London 2012 Olympics into a scaled urban map with a fluctuating landscape, which later directly informs the roof and façade tectonic of his *CAFA Union* building proposal. Ken Sheppard's 'Ceremony' creates an understanding of Japanese concept of 'Ma' – a moment of reflective pause - through a live light and sound-space installation.

All three projects explore an interaction that is precisely linked to a particular cultural event or performance to create a fluctuating architectural tectonic that becomes a performance in their own right. Begg recreates the dance of the crab with highly intricate motions through a series of precisely weighted pulleys and gears; Edwards employs a simple physical movement driven with elegant programming through *Processing*, with the resulting landscape and roof effectively becoming a live Twitter performance; Sheppard's live performers read a Laban-style score to instruments embedded with IR sensors that drive the laser and light projection, their animations also programmed through *Processing*.

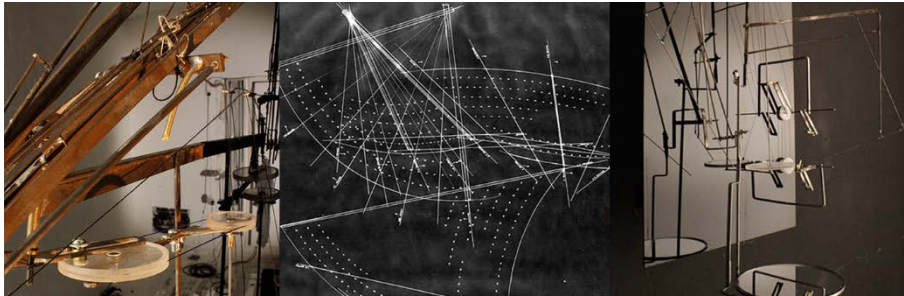

Figure 10 (L-R): Model detail; Motion analysis drawing; Model photo. Amy Begg 'Courtship and Seduction' Y3 2010-11.

[vimeo.com/DesignUnit9/AmyBegg001](https://vimeo.com/DesignUnit9/AmyBegg001)

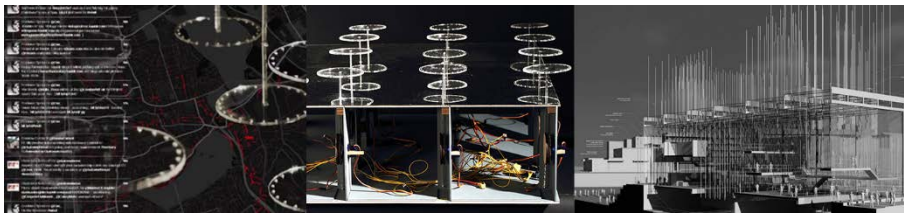

Figure 11 (L-R): Video still showing Twitter feed data driving the landscape model; model detail; render of building's fluctuating roof. Gary Edwards *London Olympic Twitter Feed* and 'CAFA Union'. Y3 2011-12.

[vimeo.com/DesignUnit9/GaryEdwards001](https://vimeo.com/DesignUnit9/GaryEdwards001) and [vimeo.com/DesignUnit9/GaryEdwards002](https://vimeo.com/DesignUnit9/GaryEdwards002)

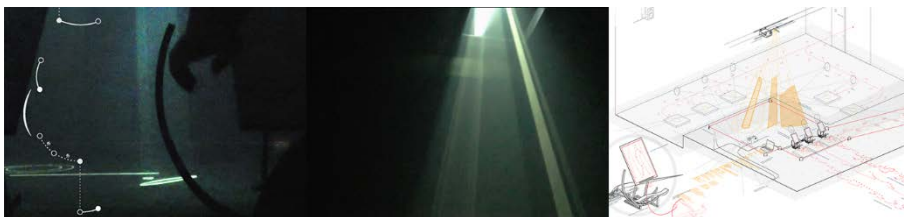

Figure 12 (L-R): Video stills showing players reading a Laban-type notation score, and resulting light boundaries; Concept Drawing. Ken Sheppard 'Ceremony' Y3 2015-16. [vimeo.com/DesignUnit9/KenSheppard001](https://vimeo.com/DesignUnit9/KenSheppard001)



## Urban x Boundary

The final three projects are concerned with the exploration of urban boundaries across digital and physical space. Robin Fu's prototype for an interactive street installation emits a ring of light, the size fluctuates with the number of people it senses, thereby alerting pedestrians of approaching fellow pedestrians. He translates this initial exploration of monitoring into his proposal for a *Sports Park in Rio*, where instead of measuring the number of people he monitors the heart rates of athletes, allowing spectators and pedestrians a glimpse into the intensity of sport events. Max Friedlander translates live weather data to affect the visual permeability and colour of the fluid dynamically driven façade and roof of his proposal for the '*Social Service of Commerce*'. Ivo Tedbury's '*Ghost Landscapes of Rio*' reveal silhouettes of a demolished urban fabric through pixelated light paintings, an invisible critique of the governments' games regeneration. Tedbury utilises the panning photography technique again in '*Circuit Atlantica*', this time to reveal motorsport specific advertising.

Both Fu and Friedlander's projects translate digital feed data into roof and façade tectonics – Fu links a Fitbit type heart monitor and generates his own heartbeat data, while Friedlander taps into Yahoo Weather. Tedbury uses pre-regeneration images from Google Maps and pixelates them into low resolution binary feeds to programme the LED pulse frequencies, generating images invisible to the naked eye but revealed through long exposure panned photographs.

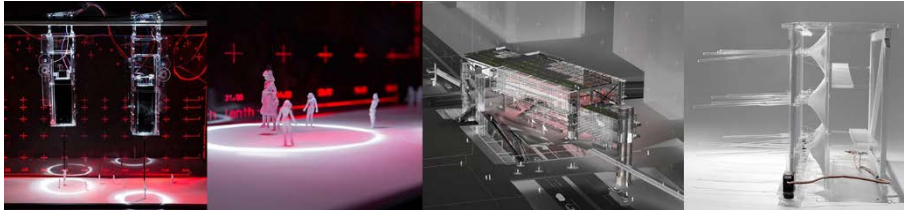

Figure 13 (L-R): Video stills '*Security Ring Rio*', '*Sports Park in Rio*' 3d view and interactive façade prototype. Robin Fu Y3 2013-14. [vimeo.com/DesignUnit9/RobinFu001](https://vimeo.com/DesignUnit9/RobinFu001) and [vimeo.com/DesignUnit9/RobinFu002](https://vimeo.com/DesignUnit9/RobinFu002)



Figure 14 (L-R): Prototype fluid dynamics model; Façade roof interactive model; Roof construction drawing; Final concept model. Max Friedlander Y3 2012-13. [vimeo.com/DesignUnit9/MaxFriedlander001](https://vimeo.com/DesignUnit9/MaxFriedlander001) and [vimeo.com/DesignUnit9/MaxFriedlander002](https://vimeo.com/DesignUnit9/MaxFriedlander002)

## Interactivity and performance in the exploration of architectural narratives.

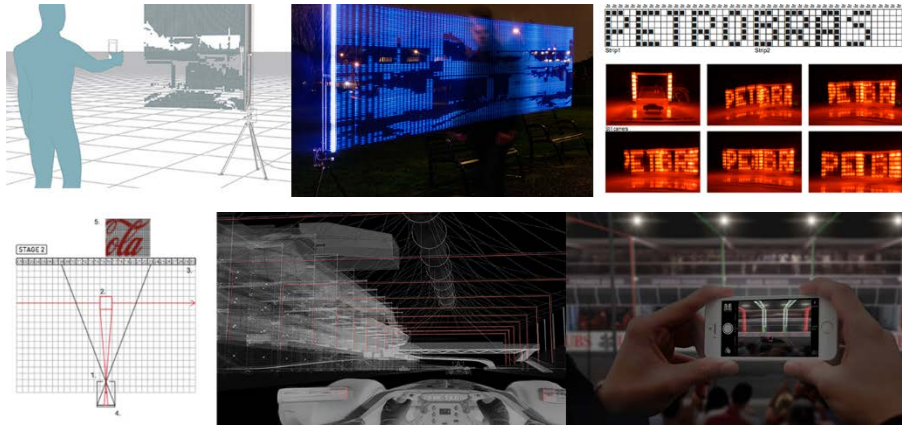

Figure 15 (Top L-R): 3d model sketch; Light painting device; programming advertising tests; (Bottom L-R): capturing advertising through panning photos; Final proposal rendered as a point cloud, car view; Final proposal spectators' view. Ivo Tedbury, Y3 2013-14. [vimeo.com/DesignUnit9/IvoTedbury001a](https://vimeo.com/DesignUnit9/IvoTedbury001a) and [vimeo.com/DesignUnit9/IvoTedbury001b](https://vimeo.com/DesignUnit9/IvoTedbury001b) and [vimeo.com/DesignUnit9/IvoTedbury002](https://vimeo.com/DesignUnit9/IvoTedbury002)

### Conclusions

The agenda of *Unit 9* works with the friction in architectural education between the use of interactive computation methodologies and traditional design teaching. We see Performance and Interactivity as intrinsically linked to the development of technology – technology beyond the discipline of Architecture. Although we are living in an age of technological abundance, we are critical of the passive consumption of technology and the lack of criticality in its application to design processes. We aim to make interactivity and technology work with design and vice versa, as an integral part of the design thinking from inception through to final representation.

Our teaching methodology strives to impart an architectural intent for projects to be engaging, contextual and relevant to its locale, and actively contributing to the discourse. Ultimately we strive to present the viewer a representation as close to the sensation of occupation, rich in ideas, narrative and experience.

### Acknowledgements

Co-Design Tutor (2008-2014): Max Dewdney; Physical computing consultant: Denis Vlieghe; Technical Consultants: Arup Associates (Mick Brundle, Adam Smith, James Ward); Students: Aya Ataya, Amy Begg, Thomas Chu, Gary Edwards, Max Friedlander, Robin Fu, Freddie Hong, Achilleas Papakyriakou, George Proud, Ken Sheppard, Isaac Simpson, Matt Taylor, Ivo Tedbury, Roger Tung, Claudia Walton

### References

- Hann, R.: 2012, Blurred Architecture, Duration and performance in the work of Diller Scofidio + Renfo, in: Performance Research: A Journal of the Performing Arts, Volume 17, Issue 5
- Latour, B.: 2007, Reassembling the Social: An Introduction to Actor-Network-Theory.
- Hardingham, S.: 2012, Supercrit #1 Cedric Price Potteries Thinkbelt, pg.12.
- Atwood, M.: 2011, In Other Worlds, SF and the Human Imagination, pg.58.

## Breathing Surface:

### *Pattern Generation with Origami Tessellation*

**Şeymanur Yıldırım**

*Istanbul Technical University*

*İstanbul, Turkey*

*seyma\_yildirim1007@hotmail.com*

**Begüm Aktaş**

*Istanbul Technical University*

*İstanbul, Turkey*

*aktasbegum@gmail.com*

**Abstract** This paper illustrates the development of kinetic 3D surfaces by utilizing open source prototyping platform Arduino. In order to generate 3D patterns, shape grammars and origami tessellation are utilized.

**Keywords:** *origami tessellation, shape grammar, interactive design, kinetic behaviour, Arduino script, computational design.*

## 1. Introduction

As Demaine, E. and O'Rourke (2007) have pointed out folding and unfolding problems have been examined since Albrecht Durer in the early 1500s but have only recently been studied in mathematical literature . Over the decades, interest in origami has increased among mathematicians, physicists, engineers, architects, and even in biomedical researchers. Origami is the art of folding a sheet of paper into various forms without any intentions of cutting, stretching or gluing other pieces of paper. Origami can be applied to manufacturing complex 3D forms by bending and folding. Based on simple deployment mechanisms, Origami derivative forms and particularly those based on the Yoshimura and Miura patterns allow a controlled transfer of forces without the need for any secondary support structure. These forms also demonstrate kinetic behaviour through translation and rotation. The critical issue is to choose the proper origami tessellation in its natural characteristics of kinetic behaviour through translation and rotation.

This paper is organized as follows. Section II presents shape grammars of Origami and patterns. Section III shows the kinetic and generative relationship embedded in pattern in Origami. Section IV gives builds on this idea as a prototype. Section V presents conclusions.

## 2. Shape Grammar Rules of Pattern and Origami Tessellation

Shape grammars are the algorithmic systems used to analyse existing designs or create new ones. In spite of using text or symbols to express abstract representations, shape grammars aide the creation of novel designs through computational efforts regarding shapes and rules. Shape grammar applications guide the designer towards emergent design possibilities. Many probabilities of rule selections and applications of these rules may generate emergent design

## Breathing Surface: Pattern Generation with Origami Tessellation

solutions or create new design objectives. This paper aims to present shape grammar characteristics and mathematical properties of Origami to allow a new system to be more generative. In order to combine Origami and pattern rules, firstly, Origami shape grammar rules (mathematical and geometrical properties of origami) are investigated. Thereafter, according to what we have learnt from the stages of the development of origami, we studied pattern generation of shape grammar methodology.

### 2.1 Mathematical and Geometrical Properties in Origami

As Arthur Lebee pointed out Origami's mathematical and geometrical properties have been studied for years. There is a deep connection between Origami and mathematics and over the last decades, a dedicated new theoretical field of research has emerged: Origami mathematics.

Although Origami has been acknowledged for a long time, it was in the 80's that seven axioms of the geometrical potential of it were defined, the Huzita-Hatori axioms. Clemen Fuchs presented it was proved by Lang that these axioms completely describe all operations that can be performed by paper folding and therefore they are now the fundamentals of the mathematical theory of paper folding.(figure 1)

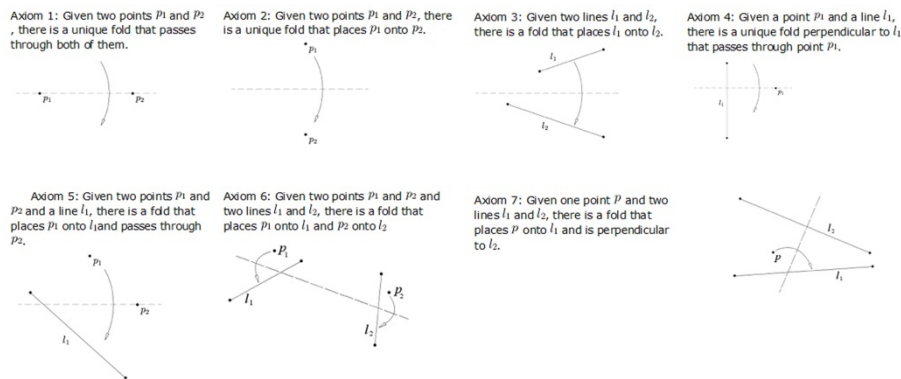

Figure 1

The given set of points and lines on the sheet of paper by observing the Huzita's seven axioms allow the user to create new lines, new intersections and define new additional points. Repeating these steps allow us to generate the crease patterns of the intended final object. From these objectives, we have learnt that every point on a flat surface needs an asymmetrical point in order to generate the pattern relation. Then, we have investigated possible folding patterns to generate other new shape grammar pattern rules, which we defined.

### 2.2 Origami Types

Currently, Origami is categorized into four types; Traditional, Modular, Wet Fold and Rigid. In Traditional Origami, a square of paper is the starting point and it is folded, without cutting or gluing, until it reaches the final object. The most simple and childish figures are done by this type of Origami rules. In modular Origami,

Models are made from units, i.e., identical pieces modelled from several sheets of paper that interlock to form the final model. In Wet Fold Origami, a special type of paper is used as a thickening agent, and modelled by wetting the paper as you fold it. This kind of Origami works more like a sculpture. In Rigid Origami, the final figure is created by folding a single sheet of paper which is not a square, without cutting or gluing. In this type of Origami, the faces must always be flat, that is, the faces cannot bend and it must be possible to flatten the model without creating new creases. For the pattern generation, we need a single piece of sheet to form a 3D surface. Consequently, Rigid Origami tessellation is a good choice of topic to broaden this field of research.

### 2.3 Rigid Origami Construction

As Schenk, M. and Guest, S pointed out rigid Origami folded surfaces are of great interest in the fields of architecture and engineering, not only because of the aesthetic possibilities but also because of the structural and elastic qualities. The most direct mechanical model is derived from the concept of rigid folding. This rigid origami model should have rigid faces with straight fold lines and perfect hinges. Therefore, despite using a rigid material which does not have any elastic properties, the surface has the power to grow, shrink and adapt to many configurations. These are the reasons that make these folded surfaces particularly suited to meet the requirements of kinetic surfaces that one wants to be light, self-supporting and able to assume different forms in a kinetic way.

As Davis, Eli, Erik D. Demaine, Martin L. Demaine, and Jennifer Ramseyer (2013) have pointed out taking full advantage of the elastic properties of Rigid Origami we can find its use in temporary, mountable and demountable structures, such as the Recover Shelter by Mathew Malone or the Corogami Folding Hut by David Penner. The way these authors use the Origami structures allow the structures to be deployed so they can be transported or stored, and when they are in use they are self-supported and do not require any additional structural element, however when not being used they remain static.

By using computational methods, the crease pattern of the Water bomb Tessellation provides us with a basis to apply the agreed pattern onto quadrangular tessellation of origami. (figure 2/c). This prototype was developed by Ron Resch.

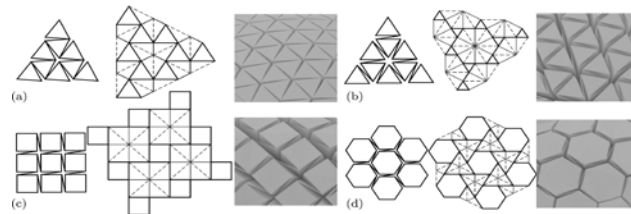

Figure 2

We chose the square (figure 2/c) primarily to enlarge the surface in a rhythmic and regular repetition. In other words, the basic flat pattern consists of square grids and also the folding 3d surface creates cubical volumes. After we decided which particular form of Origami to use, we investigated the shape grammar of that Origami.

## Breathing Surface: Pattern Generation with Origami Tessellation

Here, shape grammars are used to generate dimensional patterns which are then folded into 3D interactive patterns. Meryem Uluç presented in this is a basic concept, developed in six steps.(figure 3)

1. In order to produce the pattern, firstly, the square is accepted as an initial geometry.
2. The edge of the initial geometry (square) is copied and then a mirrored version is placed below this.
3. The geometry is rotated 90 degrees. Then, one edge of the initial geometry is extended as big as the edge and put the mirrored version.
4. The third step is repeated.
5. Diagonals are drawn in the middle of the square.

Finally, choose one of the squares and repeat the same step

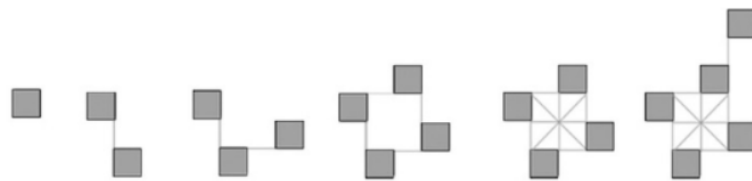

Figure 3. Step 1 Step 2 Step 3 Step 4 Step 5 Step 6

### 2.4 Shape Grammar Rules for Pattern Generation

In the water bomb Origami tessellation, if each square has an identical pattern, there would be no pattern variation when folding a 2d surface. From understanding the water bomb folding grammar, the pattern should distribute itself on a flat surface like an isometric mirror repetition, because when flat surfaces are folded, Origami turns into the generator of the pattern. Basic geometry of a pattern consists of 4 square panels like in the figure.

Basic patterns consist of A, B, C and D cells. From the repetition of these cells, patterns emerge. Therefore, A-B and C-D are mirrored from 1 axis of the square. Moreover, A-C and B-D are mirrored from 2 axes of the square. When a 2D surface turn into a 3D surface, the location of the cells change, and the relation of these is generated. Therefore, Origami becomes a pattern generator.

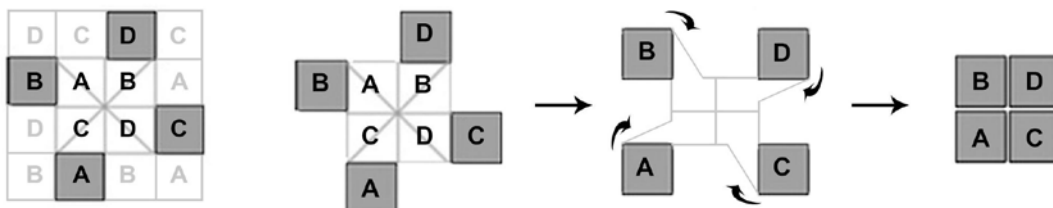

Figure 4

The purpose of our project is to make a pattern surface generator with using computational techniques. After the investigation process, we understood that the transformation part with the Origami tessellation changes the pattern organization as shown in the figure. Moreover, Origami

is a good choice for creating kinetic surfaces and also 3d surfaces with different pattern relations. Then, shape grammar rules are developed to juxtapose with Origami.

Firstly, we defined the existing rules, and then generated new rules. When cells are investigated, cells have a connection with B and C in both situations (in 2D and 3D). However, most importantly, when the origami transforms, the point on the edge of A-B, the point changes location.(figure 5)

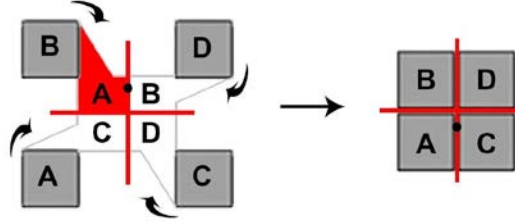

Figure 5

Then, this point becomes a part of the A-C relationship and a dynamic 3D pattern is achieved. These changes supply the dynamic 3D model. The second point is that the square has 4 axes: vertical, horizontal and two diagonals. However, in the pattern generation process, only diagonal axes should be used. If the pattern is symmetric on the horizontal and vertical axes, after the sheet is folded, it does not change and it is only the pattern that shifts as shown in the figure 6. (First pattern on 2D surface, second pattern on 3d surface)

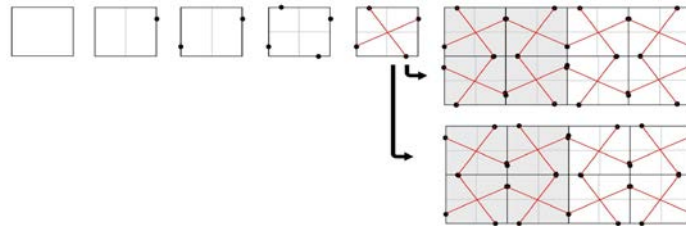

Figure 6

After this attempt, we developed a set of rules to generate designs using the shape operations of addition and subtraction, and spatial transformations familiar to designers such as shifting, mirroring, and rotating.

Shape rules of an embedded pattern in Origami:

1. Like in the Origami folding grammar, define a square.
2. Define a point on the edge of the square.
3. Mirror the point on the diagonal axes of square.
4. Repeat the same transformation on the other diagonal axes.
5. Join the points to create the base of the pattern.
6. Mirror base geometry on vertical and horizontal axes of square.



## Breathing Surface: Pattern Generation with Origami Tessellation

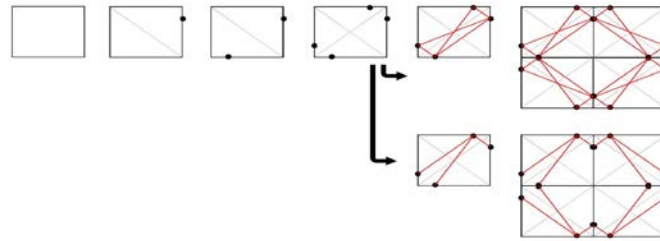

Figure 7

To make the pattern into more complex forms, more points could be added to the edge of the square or other transformation techniques like scale or rotation can be applied to the basic geometry. As shown figure seven, more control points are supplied to create a complex pattern with the same rules (figure 8). This trial is developed for a final installation on a kinetic surface. This will be explained in more depth in this paper.

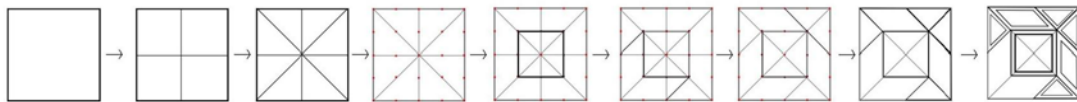

Figure 8

### 3. Kinetic Relation of the Waterbomb Tessellation and Pattern

The aim of the project is to generate patterns on 3d kinetic surfaces. To do this, shape grammar rules that use Origami folding patterns were researched. To supply the kinetic pattern generator, the initial intention was to utilise geometric possibilities of developability, flexibility and forming a smooth flat surface from Origami to modify a sheet of paper. In other words, a two-dimensional plane surface will transform into a three-dimensional square cells which provide kinetic behaviour. That is, cells that can open and close by utilising the interaction properties of Arduino to enhance the dynamic relationship between Origami and shape grammar.

According to the shape grammar, whose rules we have defined, the pattern is distributed on a flat surface with isometric mirror repetition. Then, the surface is folded to create a water bomb Origami 3D pattern. As shown in the figure 9, the first figure represents a flat surface. Moreover, the white parts are closed and not seen when sheet is folded but the gray parts are highlighted when folding the 2D surface in figure 10. These pattern generation rules are defined by the shape grammar rules.

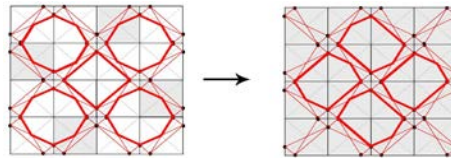

Figure 9

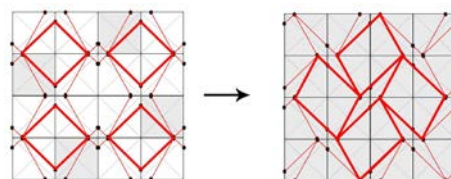

Figure 10

After we studied the working principles of Origami with shape grammar rules, more complex patterns can be created as shown in the figure 11.

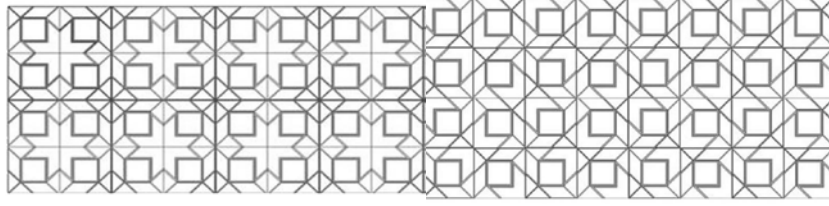

Figure 11

#### 4. Building the Full Scale Prototypes

Arzu Gönenç Sorguç, Ichiro Hagiwara And Semra Arslan Selçuk presented it in today's architecture, conventional static space is no longer adequate to describe the "contemporary space" and more efforts has been spent to provide "flexibility" in order to achieve responsiveness and thus the idea of "intelligence". Moreover, structures should be lighter and "transformable". This trend is called Kinetic Architecture. Origami also has the potential to be used in the search for kinetic structures, and understanding kinetic behaviour. In this sense, Origami can also be considered as the relation of "links" which are designed to yield either translational or rotational displacements without any "locking" problems which are an important obstacle in the design of "mechanisms". When considering the design of a simple four bar mechanism, the calculations of the forces to be applied, the dimensions of links and their proportions may not be very straightforward in the initial phase. However, any Origami folding, even with a very complex folding diagram, can easily be folded and unfolded with a single stroke of a force or torque in a stable way. Therefore, these capabilities of Origami structures are directed to create an installation according to the motion of the interest. Origami structures are light and can be easily moved and folded, in this way they can adapt to their environment with ease.

However, for this project, the goal of the project is to create installation that contains differentiation of visual perception with the generation of the pattern, which is embedded in Origami.

##### 4.1 Breathing Cells Build

Physical models have been key in advancing the project's visual, structural and mechanical aspects. How the model looks depends on how the characteristics of the surface generate different pattern organizations. An interactive prototype has been created, consisting of folded surfaces with embedded motions of cells. In the first stage of the study, motion capability of Origami was studied. For the development of the structures, squaring movable bookshelf project by Sehoon Lee was studied to understand the hinge point and working principle.

In the figure twelve to the left, the gray part shows the flat surface when the Origami is folded. The red line indicates the hinge point of the square and relationship to the others. According to that principle, when the red lines transform 180 degrees, the Origami is completely folded and a new pattern is generated as shown below.

## Breathing Surface: Pattern Generation with Origami Tessellation

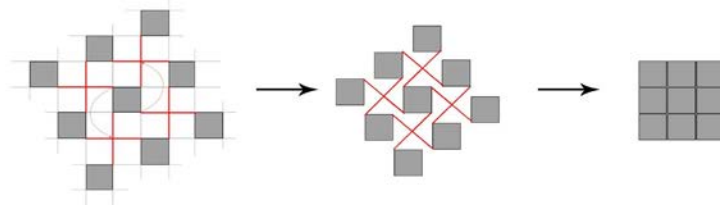

Figure 12

Each of the cells is individually controlled by the script and an Arduino board. In the script, we define the movement of cells according to an ultrasonic sensor that measures the distance of users. When users get less than one meter away, the Arduino system is prompted to start working. The motion of the system creates a twist from a fixed point, and generates new pattern organizations.

### 5. Conclusion

The purpose of this paper has been to show how shape grammars can be employed with Origami tessellation to create a more easily generative and kinetic surface pattern. So that, we presented a generative system embedding shape grammar on water bomb Origami tessellations. The shape grammar of Origami helps to determine that it is possible to get different final products, which have the same initial shape and design templates created with the same rule schemata. In conclusion, kinetic behaviour of Origami is integrated with pattern generation in interactive environments.

### 6. References

Demaine, E. and O'Rourke, J.: 2007, *Geometric Folding Algorithms: Linkages, Origami, Polyhedra*; Cambridge University Press.

Filipa Osorio ,*Geometry of Kinetic Folded Surfaces*, ISCTE-Instituto Universitário de Lisboa

Davis, Eli, Erik D. Demaine, Martin L. Demaine, and Jennifer Ramseyer ,: 2013, *Reconstructing David Huffman's Origami Tessellations*, "Reconstructing David Huffman's Origami Tessellations 1 ." *Journal of Mechanical Design* 135, no. 11

Arthur Lebéé\**From Folds to Structures*, Université Paris-Est, Laboratoire Navier (ENPC, IFSTTAR, CNRS). École des Ponts ParisTech, 6 et 8 avenue Blaise Pascal. 77455 Marne-la-Vallée cedex2

J. Smith,:1992"Understanding Geometry through Origami Axioms" in the Proceedings of the First International Conference on Origami in Education and Therapy (COET91), J. Smith ed., British Origami Society,pp. 37-70

Clemens Fuchs,:2000 *Angle Trisection With Origami and Related Topics*. Mathematics Subject Classification: 51M15, 11R04, 11R32.

Schenk, M.; Guest, S.; 2011, *Origami Folding: A Structural Engineering*

Approach, in *Origami5 - Fifth International Meeting of Origami Science, Mathematics, and Education*; CRC Press by Taylor and Francis Group,

Arzu Gönenç Sorguç, Ichiro Hagiwara And Semra Arslan Selçuk,:2009 *Origamics In Architecture: A Medium Of Inquiry For Design In Architecture* "[http://jfa.arch.metu.edu.tr/archive/0258-5316/2009/cilt26/sayi\\_2/235-247.pdf](http://jfa.arch.metu.edu.tr/archive/0258-5316/2009/cilt26/sayi_2/235-247.pdf)."

Meryem Uluç," <http://www.meryemuluc.com/de-coding-the-origami-pattern.html>"

# Biometrically-Responsive Architecture

## Mapping Biometric Data to Dynamic Spatial Change

**Avanti**

**Dabholkar**

*Carnegie Mellon*

*Pittsburgh, USA*

*avantid@andrew.cmu.edu*

**Daniel Cardoso**

**Llach**

*Carnegie Mellon*

*Pittsburgh, USA*

*dcardoso@cmu.edu*

**Abstract:** This paper reports on a project to use biometric data from human bodies to dynamically transform the thermal, visual, acoustic and olfactory experience of architectural space. Combining methods from both Architecture and Interaction Design, the project’s goal is to enable new kinds of body-space interactions triggered by biometric data. By documenting the development and testing of a series of prototypes —a petal structure that compresses and expands a room, an array of conic elements that modulates light, and finally a personal enclosure with changing sensory properties— the paper suggests an area of design research and practice we term “biometrically-responsive architecture,” or simply “biometric architecture,” linking architectural spaces and the human body in novel ways.

**Keywords:** *biometric data, soft architecture, responsive spaces, computational-driven architecture, human-centered design, human-computer interaction, interaction design, sensory mapping, physiological response*

## 1. Introduction

Unlike product and interaction design projects, such as phones or software interfaces, buildings are rarely designed with an individual “user” in mind. Rather, they are designed as stages for collective forms of experience. By proposing biometric architecture as an arena of design exploration, this paper outlines a human-centered approach to architectural experience that explores, through prototypes, the role of microenvironments in collective spaces and the way individual biometric data may elicit architectural responses.

This work expands beyond the traditional role of architects as designers of static forms, and suggests new guidelines to shape how the built environment is imagined and experienced. Consequently, the paper positions biometric architecture in the context of responsive architecture research, and documents a series of conceptual prototypes culminating in a full-scale installation. However, instead of reacting to environmental data, as many responsive environments do, this work uses biometric data to dynamically transform the sensory experience of a space.

While technical limitations have largely prevented technologists and architects from embracing affect as a design variable (Affective Computing Group 2012), recent advances make it possible to incorporate biometric data as a generative space-making tool. Biometric data sensors fall into two categories: emotion-specific sensors and binary stimulation monitors.

## Biometrically-Responsive Architecture

Sensors such as facial expression tracking, voice recognition and EEG brain mapping associate raw data with a specific emotion, while monitors such as pulse and galvanic skin response (GSR) provide binary data about the user's stimulation. Although the emotion-specific sensors provide more comprehensive data, this work demonstrates that stimulation-level data is satisfactory for initial testing. The decision to prioritize the system's output over the input also influenced the sensor selection process.

The initial prototypes use pulse data to motivate dynamic spatial change. The first prototype explores how an overhead petal structure can compress or expand a space, changing occupants' perception of intimacy in response to heart rate. A second prototype examines how animated fabric cones that control light can be biometrically modulated, also in response to the user's pulse. A final experiment is a four-foot tall personal enclosure embedded with soft architectural capabilities. Soft architecture, characterized as the non-physical manipulation of space through environmental modalities such as light, sound, temperature etc., can create environments through sensory shifts. A companion wearable device, consisting of a GSR sensor, is also designed to collect and send physiological data to the enclosure in real-time.

## 2. Background

Architects and technologists have long used computational systems to make environments more responsive, interactive and 'humane' (Negroponte 1970). Some argued for technology to be integrated with architectural design, seeking participatory design strategies and "better performing, rational buildings" (Negroponte 1975). Others, particularly computer scientists, defined responsive environments as those equipped with "intelligent" objects capable of sending and receiving data. This is now referred to as the "Internet of Things" paradigm (Weiser 1991). In the last twenty years, architectural systems design has focused on optimizing environmental and social efficiency. However, in many of these projects, architectural and spatial sensitivity are absent.

A different perspective is illustrated by the work of architects and artists such as Philip Beesley and Michael Fox, whose projects explore the experiential aspects of responsive architecture (Beesley 2010; Fox 2009). And yet, architects have rarely explored soft architecture based on personal data.

The Blur Building, by Diller & Scofidio, for example, uses both occupant and environmental data to drive a system of water nozzles to create a dynamic fog cloud. The cloud is a soft form that is a critical part of the architectural design even though it is not structural or permanent. The architects also designed "braincoats," computationally-driven raincoats that interact through glowing lights (Diller Scofidio 2002). This smart "wearable" adds to the experience of the structure by providing an user-controlled artifact that acts as a wayfinding tool in the fog cloud. The Blur Building offers a provocative example of how Architecture and Interaction Design might overlap to create a layered spatial experience and influence human behaviour.

Another relevant project is the Convective Museum, by Philip Rahm, which uses heat to create a variable thermodynamic scape (Rahm 2008). Two poles—one hot and the other cold—

create microclimates and flows within the museum, subdividing the larger public space into smaller private zones. In this way, visitors experience a dynamic space that does not require moving parts (Diller Scofidio 2002).

These works are part of a counter-tradition exploring responsive architectures as embodied experiences rather than as instruments of optimization. Seeking alignments with and expanding this counter-tradition, the biometric architecture prototypes in this paper integrate biometric data and spatial response to enhance the way spaces are experienced and shaped.

### 3. Methods

The concepts and prototypes were produced by the first author in the context of an undergraduate architecture thesis at Carnegie Mellon University, chiefly advised by the second author. A broader group of advisors, collaborators and enablers is credited in the Acknowledgments section. Over the course of two semesters, the concept evolved from an interest in responsiveness and emotion toward a focus on biometrically-responsive spaces. Inquiry methods included precedent analysis, analytical writing, diagramming and prototyping. The methodological framing was also enriched by the first author's double major in Architecture and HCI, which provided a hybrid vocabulary of techniques such as interactive prototyping, user testing, multimedia rendering and diagramming.

As discussed, prototypes exploring the relationship between biometric data and dynamic architectural response were produced at various scales and with different intents. The first two prototypes display the collective mood of a public space by averaging the biometric data of inhabitants. While both prototypes interpret sensor data similarly, they explore two different tectonic approaches to creating dynamic spatial change. In the first prototype, petals unfold from the ceiling in reaction to the collective mood of the users underneath, creating an intimate microclimate. The organic movement of the petals give the space a sympathetic personality. Although this was unexpected, the affective impact of animation became a design guideline in the following prototypes (Figure 1).

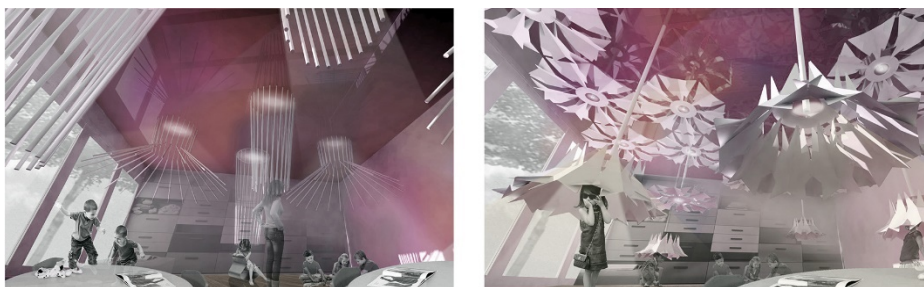

Figure 1. Digital renderings spatializing physical prototypes

The next prototype subdivides space using twisting fabric cones. The rate at which the cones twist and modulate the light was related to the emotional activity of the space, as measured by the inhabitants collective pulse rate. A matrix of these fabric “apertures” that are tuned to the spaces schedule and layout help transition occupants from one activity to another, while also suggesting new areas that are open for exploration.



## Biometrically-Responsive Architecture

Because the first two prototypes rely on a collective averaging of multiple user's biometric data, they conceal the relationship between an individual user's emotional state and the spatial output. For this reason, we shifted the scale of our final proof-of-concept to a personal enclosure -- an architecture intentionally designed for one body. In this way, the final proof-of-concept considers the direct relationship between a user and their sensory experience. This scale was inspired by initial exploratory research into the history of wearables in architecture, namely Suitaloon by Archigram and Flyhead by Haus Rucker Co. The scalar reduction also challenges what it means to inhabit architecture and to be solitary.

The third prototype consists of a four-foot tall crystalline pod structure hanging at eye level from the ceiling (Figure 2). It contains four systems: thermal, visual, acoustic, and olfactory. The thermal and visual systems consist of fans and incandescent light bulbs that regulate the temperature and brightness of the pod. The acoustic system uses real-time audio recording and playback to create an echo that varies in loudness. Finally, the olfactory system delivers four types of scents: tea tree, clove, lemongrass, and cinnamon. These particular scents were chosen based on an olfactory classification system that suggests that each category of scent stimulates a different brain region, impacting the user's emotional state (Kaye 2001).

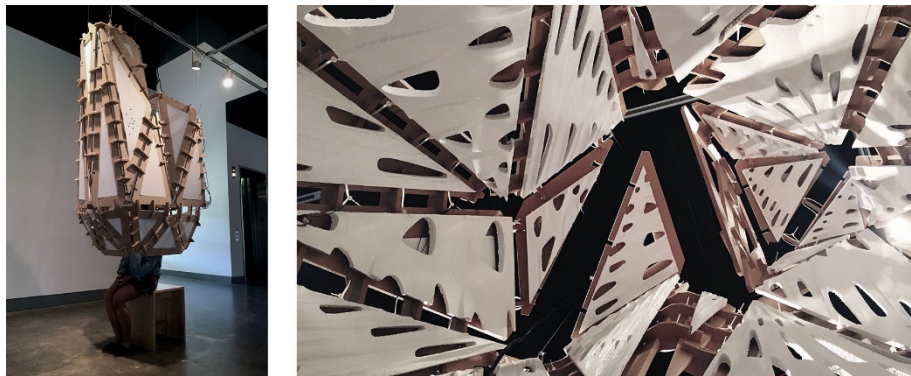

Figure 2. Final full-scale personal pod, exterior and interior

The companion wearable associated with this prototype is a galvanic skin response (GSR) sensor. The GSR sensor measures the micro beads of sweat on a user's skin to quantify stimulation. Because oxygen levels are correlated with the sensor's reading, the sensory experience of the prototype are related to the speed and depth of the user's breath. Shallow, short breaths will cause the pod to brighten, raise in temperature and volume, and release stimulating scents, while longer, deeper breaths will cause the pod to darken and cool down, releasing calming scents.

The associated hardware for each sensory change has been strategically placed in a specific region of the pod, based on an analytical study of the human head and the regions of stimulation for each of our senses. For example, our visual range is 65 degrees above and 70 below eye level, so the lights have been placed exclusively in visible areas. The sensory region subdivision on the geometry of the final prototype can be seen in Figure 3.



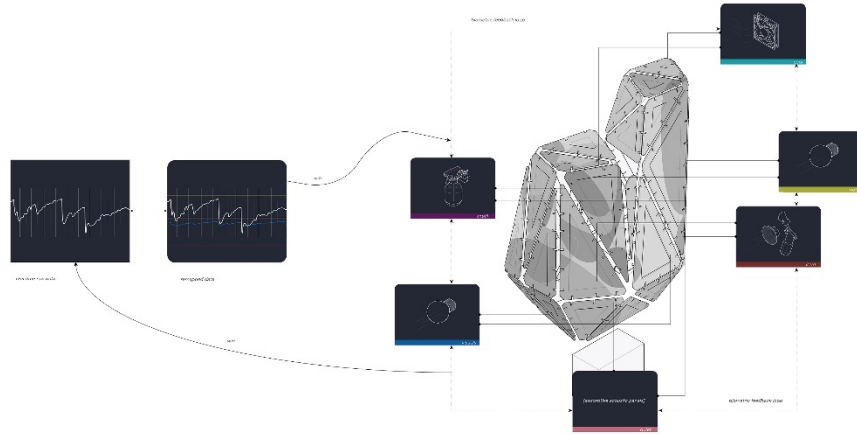

Figure 3. Sensory subdivision of enclosure geometry and associated hardware

## 4. Results and Evaluation

Based on the design, fabrication and testing of our three responsive prototypes, we propose four design guidelines for biometric architecture: sympathy, softness, enclosure and multiplicity.

### 4.1 Sympathy

The system must interact with its users through a sympathetic dialogue, not just creating an optimized feedback loop with the user's physiological response. In order to imbue the biometric architectural system with a personality and character, the response to each user must be playful and unpredictable, not optimized and predetermined. Both the user and the architecture must have agency over the responsive space that are linked but independent.

### 4.2 Softness

Instead of relying on moving parts, which are often too expensive and unreliable, biometric architecture should consider creating a dynamic experience through soft architecture. Through this toolkit, this work critiques the definition of architecture as unquestionably physical or reliant on form.

### 4.3 Enclosure

Perhaps in opposition to the previous guideline, this proposal argues for the inclusion of a static physical enclosure. An enclosure affords a user to make the explicit decision to comply in the interaction. By requiring users to crawl up into the pod, instead of walking straight in, and physically don the GSR sensor, the enclosure successfully creates a threshold that separates the microclimate from the environment it is placed within (Figure 4).

## Biometrically-Responsive Architecture

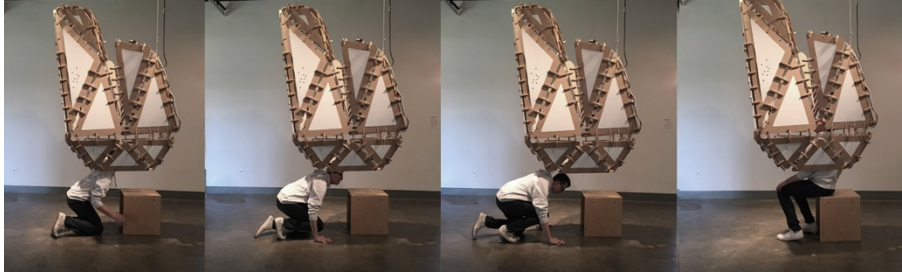

Figure 4. Sequence of entering the hanging pod

The gaps between the panels and the datum at eye level create a visual passage exterior viewers and the interior user. This relationship between exterior and interior is also reinforced by the presence of a physical form.

### 4.4 Multiplicity

It is critical that biometric architecture is able to exist in both individual and collective spaces. By subdividing larger public spaces into microclimates, a biometric space has the potential to create a layered scalar experience that affords many programs of use.

## 5. Next Steps

Four different potential space types for biometric architecture have emerged through this work: a collective space that responds to aggregated mood, a personal enclosure within a public space, a personal enclosure within a private space and a space that uses hidden delivery mechanisms to create sensory microenvironments. User testing at each scale will help validate the most appropriate scale for biometric architecture.

Feedback from real participants will also help uncover how biometric architecture affects social behaviour. The last prototype challenges architecture to exist for a single user in solitude. We will test this prototype to understand how voluntary participation in a solitary architectural system differs and complements the disconnection humans feel when they engage with mobile technology, such as smartphones and laptops. Future interviews with users will also help identify a user's motivation for wanting to participate in this type of interactive environment.

As technologies for sensing, data collection and actuation become increasingly pervasive, new questions about the relationship between our bodies and the spaces they occupy emerge. How may we approach, and shape, this landscape of technological possibility in ways that recognize both its aesthetic capacities and its critical challenges? While confronting these critical challenges certainly demands further work, the speculative concepts and prototypes in this paper outline a possible future where biometric architectures provide soft, sympathetic enclosures for individuals and collectives —ambient interfaces for human expression and performances.

## 6. Acknowledgements

Special thanks to faculty members Mary-Lou Arscott for her consistent enthusiasm and energy, Dana Cupkova for her mind-stretching feedback and Art Lubetz for always keeping an eye on the big picture. Finally, the first author's Fourth Year Design Award, enabled by a generous gift by the Burdett Family to the Carnegie Mellon School of Architecture, was a crucial source of support for this project.

## References

Beesley, Philip, Hayley Isaacs, Pernilla Ohrstedt, and Rob Gorbet. *Hylozoic Ground: Liminal Responsive Architecture*: Philip Beesley. Cambridge, Ont.: Riverside Architectural Press, 2010.

Diller, Elizabeth, and Ricardo Scofidio. *Blur: The Making of Nothing*. New York, NY: Harry N. Abrams, 2002.

Fox, Michael, and Miles Kemp. *Interactive Architecture*. New York: Princeton Architectural Press, 2009.

Kaye, Joseph Nathaniel. *Symbolic Olfactory Display*. PhD diss., 2001.

"MIT Media Lab: Affective Computing Group." MIT Media Lab: Affective Computing Group. Accessed May 07, 2016. <http://affect.media.mit.edu/>.

Negroponte, Nicholas. *Soft Architecture Machines*. Cambridge, MA: MIT Press, 1975.

Negroponte, Nicholas. *The Architecture Machine*. Cambridge, MA: M.I.T. Press, 1970.

"Philip Rahm International." Philip Rahm Convective Museum. Accessed May 07, 2016. <http://www.philipperahm.com/data/projects/convectivemuseum/>.

Weiser, Mark. "The Computer of the 21st Century." *Scientific American* 265, no. 3 (September 1991): 66-75.

# Playful Experience Within Interactive Architecture

**Anna Grajper**

*Wroclaw University of  
Technology and Science  
Wroclaw, Poland  
anna.grajper@gmail.com*

**Abstract:** Play as a form of behaviour is part of human culture from ages as a specific form of conversation between people. Transmitting play to the architectural language, as the interaction between elements of built environment and human, has been changing for the last fifty years - from the static to the interactive surrounding. In the 1960'ies Cedric Price designed "laboratory of fun" - Fun Palace. It was never built but the idea of programmable spaces influenced the future of architecture. In reference to the Price's concept, this research is based on two realised interactive projects: "Urbanimals" and "Interactive Fingers". The study addresses the issue of 'how to design playful experience in interactive environment' - especially in public spaces where users are not prepared for play. To achieve that each project explored different type of activities performed by participants as "exploring" (Urbanimals) or as "competing" (Interactive Fingers).

**Keywords:** *interactive architecture, play, experience*

## 1. Introduction

In the early 1990s Don Norman established at Apple a group called "the User Experience Architect's Office". Within that time Norman defined the term *user experience* to widen knowledge in order to *"cover all aspects of the person's experience with the system including industrial design graphics, the interface, the physical interaction and the manual"* (Norman, 2013). Afterwards, the definition started to be implemented by other designers who translated it by their own interpretation. Hassenzahl stressed that *"User Experience is just a sub-category of experience, focusing on a particular mediator - namely interactive products"*. This point of view focuses mainly on an issue of an essence of interaction between human and products such as computers, phones, or any other objects which represent an interactive system.

But, how to design a specific type of user experience mainly the playful one. As Norman states *"Technology should bring more to our lives than the improved performance of tasks: it should add richness and enjoyment"* (2004). Over the decades, introducing playfulness to objects that surround us became a desirable element of their design - it is especially visible on an example of interfaces and websites.

Thus, this article moves closer to the essence of the experience from the point of view of designing the interactive architecture and games, as the disciplines where the main aim is to stimulate human interaction with an environment. The findings about 'playful experience' in these

two disciplines are used as methodology to design and to analyse the architectural installations: 'Interactive Fingers' and 'Urbanimals'.

## 2. Playful experience

### 2.1 Architecture

*The Fun Palace* as a representation of visions and needs of the British society of the 1960s put an emphasis on the essence of leisure (entertainment) in human life. The project was an answer for emerging new patterns of human daily life, and therefore, as pointed out by Price the architecture in his perception had to be changed for more flexible and adaptable arrangements. Together with Joan Littlewood and other professionals such as Frank Newby, Yona Friedman or Gordon Pask, they designed the space - *a laboratory of pleasure, providing room for many kinds of action* (Price & Littlewood, 1968).

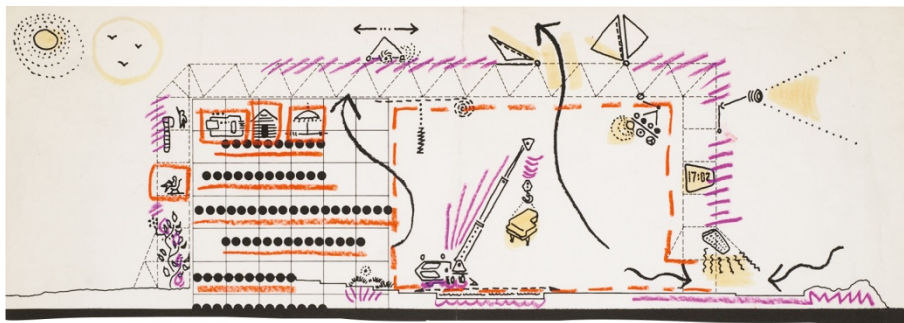

Drawing 1. Cedric Price Fun Palace: Section showing potential use of interior spaces

The concept assumed modifiable configuration of places to provide a wide range of activities. The building itself was an open framework for human performance where flexibility of spatial conditions allowed to play with the space. In that sense, Cedric Price's experimental project 'Fun Palace' was - as the author emphasised - not 'a building' but rather a frame for events. Moreover, the open plan was not only the flexible space for various activities but - as Littlewood described - there will be plenty to engage imagination and enlarge experience (Price & Littlewood, 1968).

One of the main contributor to this project was Gordon Pask with his theory of an aesthetically potent environment as the surrounding which might increase pleasurable interaction. Within that he said that the environment should consist of the following attributes:

- It must offer sufficient variety to provide the potentially controllable novelty required by a man
- It must contain forms that a man can interpret or learn to interpret at various levels of abstraction.
- It must provide cues or tacitly stated instructions to guide the learning and abstractive process.
- It may, in addition, respond to a man, engage him in conversation and adapt its characteristics to the prevailing mode of discourse.

## Playful Experience Within Interactive Architecture

Thus that project is the essence of designing not the form of the building but the possibilities of playful experiences of space. Determinants specified by Pask are used in this paper as the methodology to analyse the final results of two case studies in order to observe if they provide the basic fundamentals for pleasurable space for playful experience.

### 2.1 Game design

Designing for playfulness is strictly connected with games, so at the beginning it is worth to understand a phenomena of play. Salen and Zimmerman stress that play is a "free movement within a more rigid structure to look concretely at the ways that games build experiences for players" (2004). Play is also an activity which "generates novel ways of dealing with the environment, most of which lead nowhere but some of which turn out to be useful" (Bateson & Martin, 2013). If playful experience is so closely connected with human activity the main question arises how to design the possible actions for users for playful interactions.

In the research presented in this paper, the following case studies are designed under the methodology used in game design - 'The Core Mechanic' - which creates patterns of behavior, which manifest as experience for players. Through the core mechanic, each game creates a spectrum of activities which might be taken by users during play. As Salen and Zimmerman state, this activities are created by the system that includes the game's sensory output to the player and the play-er's ability to make input, as well as guiding the internal cognitive and psychological processes by which a player makes decisions. In that sense, creating a game should be based especially on creating not the architecture and characters but on variations of activities for players which repeat during a play.

## 3. Case studies

### 3.1 Interactive Fingers

Location of the structure: public space / main hall of Wrocław Główny Railway Station / Wrocław, Poland

Duration of the exhibition: two days (17 & 18th May 2014)

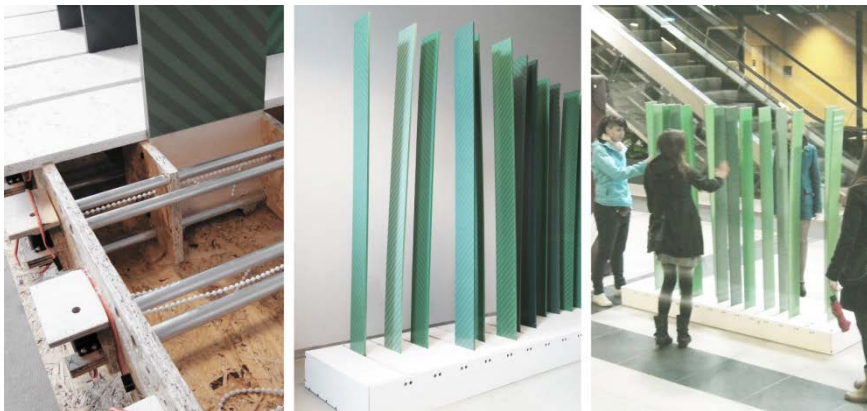

Photos 2-4. "Interactive Fingers" / design: LAX laboratory for architectural experiments

The form of „Interactive Fingers" consisted of: the horizontal base situated at the bottom of the structure, and the vertical elements (fingers) which through the electronic devices and the mechanic construction were able to be moved. The sensors detecting human movement were hidden in the base. The vertical elements were situated in a span of 20 cm from each other, in order to make available the eye contact between participants on both sides of the structure. All the electronic elements were selected to indicate playful experience where human does not need to read instruction to play with the structure.

The core mechanic of possible actions undertaken by users with the installation were designed as two scenarios to stimulate play:

a. the interaction between human and structure, or human and human through the structure.

b. the relationship of the installation with surrounding in the absence of users.

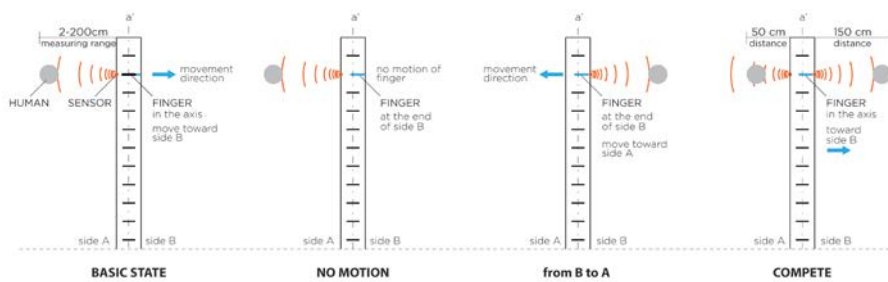

Scheme 5. Scenario type "a"

The interaction in scenario "a" was as follow:

- the basic state: The initial position of fingers was in the axis a'. The movement of particular board was activated by human motion in the scope of 2 meters distance from the sensor. The finger moved opposite to the participant. (human on the side A + the finger in the axis = motion of the finger toward the side B)
- no motion: The finger was at the end of one side (in this example at the end of side B). The movement of the particular board was not activated by human motion when participant stood on the other side than the finger. (human on the side A + the finger on the end of side B = no motion of the finger)
- from B to A: The initial position of the finger was at the end of one side (in this example at the end of side B). The movement of particular board was activated by human motion when participant stood at the same side as the finger. (human on the side B + the finger on the side B = motion of the finger toward the side A)
- compete: This type of interaction occurred when one person played with another through the structure. The initial position of fingers were in the axis a'. The movement of particular board was activated by human motion in the distance of 2 meters from the sensor. In this situation there were two users: one on the side A, and second on the side B. The finger moved opposite to participant who stood closer to the sensor.



## Playful Experience Within Interactive Architecture

The interactions in the scenario "b" - the relationship of the installation with surrounding in the absence of users - provided the random movement of "fingers" for a short interval of time from 5 to 30 seconds, in order to encourage passers-by by motion, to play with the structure.

The core mechanic of that installation was simple - get the finger on your side. The activity patterns of players gave the various possibilities to move the structure, but there was only one hidden rule of play which allowed to move the finger towards player's direction. It could happen when other person who stand on the other side of the installation, starts to interact with you - move with you along the structure.

In this case study, playful experience was brought to users through the set of scenarios which indicated motion of human body as well as motion of architecture. The motion of the structure showed that the scenario "no motion" caused that participants held longer next to the finger and tried to fit it in motion. Some of them started to use hands to pull or push the board in order to set it in motion. Nevertheless, the major amount of people in this situation moved forward to the next finger or went on the other side of the structure. The main essence of option 'compete' was rather very rarely discovered because as observations showed most of the people interacted on one side of the structure.

From the perspective of the assumptions made by Pask, it is worth noting that this case study did not fulfil enough attributions to provide the pleasurable environment. First it did not offer the enough variety and novelty which was observed that people get bored after few minutes. Second, the form of the installation was not enough understandable by people how to use it - the observations showed that they used mainly hands to activate the motion, not legs as it was designed. Thirdly it did not provide enough instructions how it worked which caused that people hardly find a main feature of that structure which was the game - "compete". But, the last attribution of the pleasurable environment was almost performed - it gave the possibility to interact with an architecture through various scenarios, the only missing point was the process of real conversation where human dose not only activate the option but he/she starts a discourse with an architecture. These observations highlighted a lack of proper design of "a core mechanic" as the understandable variations of actions which could be undertaken by users.

### 3.2 Urbanimals

Location of the installation: spaces of transitions / outdoor, 8 spots in Bristol

Duration of the exhibition: two months (mid September-mid November 2015)

"Urbanimals" was the project of interactive visual installations displayed on the empty surfaces across the city. It drew inspiration from the traits of popular animals and implied them into an adequate activity. One could met Urbanimals in every space of transition in the city of Bristol, and actively participate in their performance.



Photo 7. Urbanimals / design: LAX laboratory for architectural experiments

Play with the city through Urbanimals was based on behaviour patterns of four animals which differ their activity from each other.



Drawing 8. Urbanimals / design: LAX laboratory for architectural experiments

The core mechanic of possible activities with the surrounding were designed particularly for each animals as follow:

- a rabbit: the goal of interaction was to manage to touch it. The achievement of this depended on the human body movement - a speed. The slower participant moved toward rabbit, the longer it stayed in one place.
- a dolphin: an interaction was based on the goal that participant has to follow and to mime behaviour of dolphin.
- a kangaroo: actions and reaction depended on human movement - human was the main initiator of kangaroo's behaviour.
- a beetle: participant tried to disturb it rolling over a ball.

The playful experience was brought through jumping, sneaking, crouching or waving hands. The goal was to catch a rabbit, jump higher than kangaroo, stroke the dolphin, or get the beetle's ball. The solution how to achieve these goals was not presented for users - each of them had to discover it by him/her-self. The helpful signals were their personality hidden in their appearance which is strongly connected with human imagination about these animals in nature or toys world.

The observations of interactions between people and Urbanimals showed that the project meet the assumption of the pleasurable environment (Pask). Each animal provided wide variety of behaviours as well as novelty each time when people started to play with them. The second attribute was also satisfied because people easily learned and interpreted what the possibilities of play were. The third issue also was provided through behaviour of animals, each of them

## Playful Experience Within Interactive Architecture

repeated some of actions to indicate the next actions. As well the last attribution was attained through the random loop of possible movements made by animals toward people.

### 5. Conclusions

This study examined playful experience as a experience which emerged through play as a specific type of interaction between human and environment. In this research the playful experience was mostly visible through the participant's engagement with installations illustrated by the movements and actions taken by people. Like in the essence of 'The Fun Palace', the realised case studies were not focused on appearance but rather on possible events which might happen within interaction between human and interactive objects. The human activities presented in case studies showed that the core mechanic as the possible spectrum of actions within game, plays an important role in order to design the playful environment. It means that the activities which players might perform within the event can stimulate to further, deeper and longer play. Moreover the observed participants' forms of behaviour stressed that they are eager to interact with extraordinary environment, even in public spaces, they just need to be stimulated and encouraged in a proper way.

### References

- Bateson, P., & Martin, P.(2013). Play, playfulness, creativity and innovation. Cambridge : Cambridge University Press.
- Hassenzahl, M. (2010). User Experience and Experience Design. in The Encyclopedia of Human-Computer Interaction, 2nd Ed. <https://www.interaction-design.org/literature/book/the-encyclopedia-of-human-computer-interaction-2nd-ed/user-experience-and-experience-design> (accessed 25 March 2016).
- Mathews, S. (2005). The Fun Palace: Cedric Price's. *Technoetic Arts: A Journal of Speculative Research* Volume 3 Number 2. , 73-91.
- Norman, D. A. (2013). *The Design of Everyday Things: Revised and Expanded Edition*. New York: Basic Books.
- Norman, D. (2004). *Emotional Design: Why We Love (or Hate) Everyday Things*. New York: Basic Books.
- Pask, G. (1970) A Comment, a Case History and a Plan in J. Reichardt. (ed.), Rapp (ed.), and Carroll (ed.) *Cybernetic Serendipity* (1970) reprinted in J. Reichardt. (ed.), *Cybernetic Art and Ideas*. (1971) London: Studio Vista. pp. 76-99.
- Price, C., & Littlewood, J. (1968). The Fun Palace. *The Drama Review: TDR* , 127-134.
- Salen, K., & Zimmerman, E. (2004). *Rules of Play - Game Design Fundamentals*. Cambridge: MIT Press

### Images:

Drawing 1. © CCA, Cedric Price fonds, Collection Centre Canadien d'Architecture/ Canadian Centre for Architecture, Montréal <http://megaestructuras.tumblr.com/page/8> (accessed 20 March 2016).

Photos 2-4. Image by Sebastian Dobiesz

Photo 7. Image by Paul Blakemo

**Ruairi Glynn**

*Interactive Architecture Lab*

*Bartlett School, London, UK*

*1st Author email*

At Trinity College Dublin, in 1943, to a packed audience of academics and dignitaries including then-Taoiseach Eamon de Valera, Austrian physicist, Erwin Schrödinger, delivered his illustrious Lecture titled *What is life?* Taking principles of his own scientific field and placing them onto the study of cell biology he proposed the idea of a “code-script” with all living things holding the “entire pattern of the individual's future development and of its functioning in the mature state.” (2012: 21) Within a decade Watson & Crick's confirmed his hypothesis describing the double-helix structure of DNA, the hereditary mechanism of all biological life and the foundations of the science of genetics. In honour of Schrödinger's contribution, Trinity College Dublin in 2012 hosted another packed audience including standing-Taoiseach Enda Kenny for a follow up Lecture. Again titled *What is life?* The appetite for answers was clearly undiminished. Its speaker, American geneticist, John Craig Venter, offered his definition.

*All living cells that we know of on this planet are DNA software driven biological machines comprised of hundreds of thousands of protein robots, coded for by the DNA, that carry out precise functions.*

Researchers at the J. Craig Venter Institute had sensationally announced to the world in May 2010 to having successfully constructed the “First Self-Replicating Synthetic Bacterial Cell.” By substituting the genome of a host bacteria with a fully synthesized genome they had in effect created the first synthetic life form. To distinguish their computer programmed DNA from the original genome it was copied from, they encoded the names of the authors of the research, a website address and for good measure three quotes touching upon the significance of their endeavour. “To live, to err, to fall, to triumph, to recreate life out of life” was chosen from James Joyce's, *A Portrait of the Artist of a Young Man* (1916) and from American Prometheus (REF), the biography of Robert Oppenheimer, “See things not as they are, but as they might be”.

The third and final encoded statement “What I cannot build, I cannot understand”, attributed to physicist Richard Feynman transpired to be a misquote of “What I cannot create, I do not understand.” (Venter, 2012). Regardless of this minor but somewhat embarrassing error, either version touches on the underlying reason for perhaps humanity's greatest technological and philosophical project. Motivated by questions, both metaphysical and scientific on the origins of

## Machine Life

life and consciousness – with ever greater resolution – man has mimicked the forms and behaviours of life to better understand them.

Venter's view of life is unapologetically mechanistic. His code instructions programme protein automaton, just as a roboticist may engineer a servomotor mechanism. His work and that of his team, is the latest step in a long and extraordinary history of machine making. Of artistic and scientific enquiry that with every step has further dissolved distinctions between natural and artificial, animate and inanimate, animal and automata.

*"What we observe is not nature itself, but nature exposed to our method of questioning"*  
Werner Heisenberg (1958:58).

The technologies of their time give the instrumentation for examining *life* and at the same time shape our conception of it. To provide a full historical account is beyond the focus of this discussion, but its useful to reflect on how today's concepts of machine, autonomy, adaption, emergence and complexity – formed from the conflict between a human tendency towards *Vitalism* and modern science's tendency towards reductive mechanism. Neither have provided entirely satisfying answers to the questions of *What is Life? Or perhaps how we experience the performance of life?* But the friction between has inspired great inventions of technology, philosophy and art that continue to inspire discourse. So I will begin by skipping the legendary mythological automaton makers of Daedalus and Pygmalion, the early inventors Ctesibius (285–222 BC) and Heron (10 - 70AD), and illustrious Ismail al-Jazari (1136–1206AD) and we will start with where an Architect, unintentionally inspired the beginning of the end of animism in Western Philosophy.

### A Living Architecture

In 1598, Tommaso Francini, a Florentine architect accompanied by his brother Alessandro arrived at the gardens of the royal chateau of Saint-Germain-en-Laye to begin building what are considered the high point of Renaissance automaton (Bedini, 1964:27). Hydraulic statues enacted mythological tales, danced, played music and even spoke in what must have been for visitors of the time, an extraordinary, perhaps even supernatural experience. In 1614, a young man recovering from the first of several breakdowns hid himself away in Saint-Germain for two years. So fascinated by automata, records suggest he built his own (Smith, 1978:81). But it was not so much what he made, but how these artful machines shaped his way of thinking that was to cause perhaps the greatest epistemological shift in the western world. A way of looking at the world that exorcised science of its animist tendencies.

*Revolutions in thought are usually steady maturations suddenly completed. In emotional moments the gathered ideas of one mind decisively collect into a single vivid intuition. In such a*

*moment of the year 1619 the Angel of Truth announced to the dreaming Descartes that the material world was geometrical. In that moment of insight Descartes beheld a physical world of extended things with figures and motions. The vision perpetuated a permanent conviction that the material world was a vast assemblage of figured bits of extension in motion, or with relative rest... Versions of physical nature provided by the animate model, by the analogy of the living thing, gradually waned, and then dramatically succumbed, before the mechanical philosophy of the geometric ideal. (Gregory 1927:305)*

The influence of Descartes division of matter, machine and the body on one side from mans thinking, mind and soul on the other, presented God as the Architect of a marvellous automaton. The physical world became ordered, just as a clock or water-driven organ might be, so that things and their behaviour with study, could be mechanically explained. The *enlightenment* had begun, and so with it, the age of machines in which automaton flourished with exuberance.

While I could now recount numerous artisans who would follow the work of Francini Brothers, I'll mention just one who optimises the parallel pursuits of artistic and scientific invention characteristic of the great automaton makers. A Jesuit trainee monk, Jacques Vaucanson born 1709 in Grenoble, France, developed an interests in mechanics by making flying automaton angels. Finding his Jesuit superiors disapproving of his hobby – so much so that they destroyed his workshop – Vaucanson left the church and began a career that earned him the reputation as Historian Silvio Bedini described it, of 'Unquestionably the most important inventor in the history of automata, as well as one of the most important figures in the history of machine technology.'(1964:36) Vaucanson first made his name with a series of life size flute playing androids, but it was an infamous mechanical duck (1739) that secured his name in the history of performing machines.

The life size automata would eat, drink, stamp its webbed feet in water and most momentarily digest food and excrete much like a living duck might do. It was a phenomenon, and toured internationally performing to enchanted crowds, bringing him wealth and notoriety. Vaucanson's interest in replicating digestion had however begun before his musical automata. Having studied anatomy and with an interest in medicine, he had earlier tried unsuccessfully to build a workings imitation of a functioning human body. His failure to have achieved this ambitious goal, would it seem, to have provided the necessary lessons to allow him to achieve his comparatively simpler but nonetheless critically acclaimed automata.

*All the movements and attitudes of this automaton faithfully reproduce nature, copying it to the life even down to the tiniest detail, so much so that for a moment we are tempted to believe that there is a real duck before us..... we have no doubt that the discoveries of this master mind will make his name immortal (Chapuis and Droz 1958:239)*

Beyond his theatrical achievements, Vaucanson was to discover a means of making flexible tubing from Indian rubber, probably while trying to replicate vocal cords or the digestive

## Machine Life

tract. The discovery was to find countless applications in industrial applications. He was also to make improvements to machine tools decades ahead of their time but it is undoubtedly his invention and refinement of an automatic weaving machine erroneously attributed to Jacquard (Name 1964:38), that Vaucanson deserves greatest mention for. It was the genesis of programmable machines that were to lead to the age of computing.

Vaucanson alongside other great automaton makers such as Leonardo da Vinci, Wolfgang von Kempelen, James Cox and John Joseph Merlin, Pierre Jaquet-Droz and his son Henri-Louis, dazzled the world while innovating in machine technology. Surprisingly their machines were often treated as mere curiosities to the artistic and scientific communities alike – yet their works have been immortalized in the history of technology. For those seeking mechanistic explanations of life, in alignment with the astronomy, mathematics and physics, of Copernicus, Kepler, Galileo, Bacon, Descartes, and Newton – these machines took a theatrical role in the exorcism of vitalist science. If Vaucanson could make a duck so lifelike, how long before man could indeed play God?

When in 1780, Italian physician Luigi Aloisio Galvani discovered the muscles of dead frogs' legs jumped when stimulated by an electric charge, he was the first to recognize a relationship between electricity and *life*. It also deflated if you'd excuse the pun, other theories of animation such as the balloonists who believed muscle contraction involved fluids or gases. Soon the making of lifelike machines would move from pneumatic and hydraulic mechanisms towards electromechanical brains and servomechanisms in the perennial search for evermore lifelike forms of behaviour.

## Cybernetic Life

Neuroscientist W. Grey Walter came to an interest in Cybernetics recognising that negative feedback control processes in machines were analogous to those found in biological nervous systems. The dynamic stability of sensory-motor systems was as Walter pointed out, something that physiologists had a head start on studying before engineers began formulating their own principles of control (1950:207). Machine's provided a necessary means of physically modelling sensory-motor behaviour, that Walter hoped might uncover some of the many mysteries of the human brain. He built a series of *Electro-Mechanical Animals* called *Machina Speculatrix*. Due to their domed shell body and slow pace they were often affectionately called *tortoises* and among some of the earliest autonomous robots built.

Each tortoise consisted of a pair of electrical circuits built to simulate nerve cell functions coupled to motor functions. A photo-electric *receptor* enabled the tortoises to sense and steer motion towards light – *positive phototropic behaviour*. The second *receptor*, an electrical contact switch, sensed collision with obstacles altering direction of travel. The robots would explore continuously their environment attracted to light sources until a threshold of light exposure would be met, at which point they would turn away – *negative phototaxic behaviour* – and the process



would begin over again. A *recharging hutch* with a light above it assisted the tortoises in finding their way to a source of energy giving them the ability to sustain continuous activity autonomously. These robots, even by the engineering standards of the day, were electro-mechanically primitive. The *extreme economy* of design as Walter described it, didn't lead however, to an economy of behaviours. Instead the robot performed a variety of complex patterns of movement.

*Most compellingly, these behaviours were “remarkably unpredictable” with a “strange richness ... [found in] animal behaviour—and human psychology”. A quality of “uncertainty, randomness, free will or independence” Walter remarked, “so strikingly absent in most well-designed machines.” (1950:44)*

These were the successors to life imitating automatons, representing a radical shift in approach. Whereas Pierre Jaquet-Droz's *The Writer* (1772), consisted of 6000 exquisitely crafted mechanical parts, Walter had built his from only a handful of electro-mechanical components. Whereas programmable automatons were completely predictable and repetitive, Walter's two tortoise named *Elmer* and *Elsie* would never repeat the same exact behaviours twice. Neither entirely consistent, nor random in motion – they seemed to operate on the threshold between order and chaos, performing qualitatively differently to anything built to imitate life before them.

The sensor-motor nervous system of the animal brain now had an electro-mechanical simulacrum in machines. Unlike the animal brain however, it consisted of only 2 analogous cells rather than the billions of cells of a human brain. Nonetheless to observers, the volitional behaviour of these tortoises was compellingly *intelligent*. While the other famed early Cybernetic Machine - the *Homeostat* – by Ross Ashby, attempted to find stability within itself, Walter's *tortoises* attempted to find stability through their interaction with their surrounding environment. By modifying the environment, such as the location of sources of light or obstacles, a surprising variety of patterns of behaviours would emerge.

One of the most interest examples given by Walter, was observed when a tortoise passed in front of mirror. An on-board indicator light – intended only for Walter to observe the machines internal state – was detected by the tortoises own photocell causing an unexpected flickering behaviour. The light sensed by the photocell activated a change in state in the robot that in turn switched off the light, which in turn changed the state of the robot back to its original light on state, which in turn switched the light off again, leading to an oscillating motion and corresponding flickering light. Walter quipped, such a behaviour could even be (mis)interpreted as form a self-recognition. When *Elmer* and *Elsie*'s were observed close to one another, a similar but distinctive pattern of behaviour would occur. Each attracted by the light of the each other, would enter into a reciprocally oscillating motion. Author of *The Cybernetic Brain*, Andrew Pickering, likened it to a tragic mating dance (2010:43), a lively and seemingly creative higher-order behaviour emerging from the interaction of a pair of robots endowed each with only a couple electro-mechanical nerve cells. Such interpretations of course were not beyond dispute, raising questions of where indeed the *intelligence* and *novelty* lay in the behavior of these machines.

## Machine Life

### Behaviour & Performativity

The tight-coupling between the features of the environment and the tortoise's behaviour presented Walter with the opportunity to study his *Machina Speculatrix* by modifying the environment they inhabited, rather than tampering with their internal electro-mechanical composition. This approach was strikingly similar to the deductive study of animal behaviour exemplified by Pavlov (1927) Thorndike (1898) and Skinner (1938) where the inner workings of the brain are inaccessible, so environmental stimuli are modified and resulting behaviour observed. In electrical engineering, deductive methods, are also common whenever parts of a system are inaccessible. Ashby describes an engineer "given a sealed box that has terminals for input, to which he may bring any voltages, shocks, or other disturbances he pleases, and terminals for output, from which he may observe what he can." (Ashby 1956:86) Without access to the box the engineer has no choice but to develop a hypothesis, observing the relationship between in- and output signals. The hypothesis can be tested and refined over time although though it may never be possible to know the contents of the box. The goal therefore is not to necessarily *know* what is in the box, but rather how it performs.

*"What is being suggested now is not that black boxes behave somewhat like real Objects but that the real Objects are in fact all black boxes, and that we have in fact been Operating with black boxes all our lives." Ashby, An introduction to cybernetics (1956, 110)*

Borrowing from engineering terminology, Ashby adopted the expression, *Black Box*, extending it to describe the problem of studying all behaviour. Dedicating considerable attention to it in *An Introduction to Cybernetics* (1956), he develops the argument that the *Black Box* encapsulates how we all encounter the world and make sense of it. The *modus operandi* of all human interaction with the world, he gives an example of a child who learns to control a door handle without seeing or understanding the internal mechanism. Once mastered, most people live a comfortable life never looking too closely at a door handle again and such little mysteries constitute one of the innumerable daily *Black Boxes* we engage with in a world not fully open to inspection.

*"Ashby went so far as to suggest the Black Box might not be just a useful device, but universal, suggesting that we never really see what's causing a change, only some explanatory principle we take as a mechanism." Glanville (2002: 62)*

Ashby's *Black Box* develops Cybernetics as an approach to understanding the world through a performative lens. As an approach to scientific study, it counters the classical fixation with needing to "know what's inside", as such knowledge doesn't necessarily help predict or study the emerging behavioural phenomena. In the case of Grey Walter's electro-mechanical animals – even with his intimate understanding of the material composition of the machines he found "it is

often quite impossible to decide whether what the model is doing is the result of its design or its experience" (1953: 271). Ross Ashby's Black Box was undoubtedly shaped by the challenges he faced in building and studying his own Homeostat. Challenges all too familiar to pioneers of robotics and autonomous systems ever since. As the study of systems became increasingly complex, from the tortoise's simple two neuron brain up to the many millions of animals, from individual animals to ecologies, from company accounting machines to entire economies, the performative approach to studying behaviour appears increasingly necessary. To take a Cybernetic approach to a subject is to be concerned with what neurophysiologist Warren McCulloch and Kenneth Craik called "the go" of things, the relations between things and their changes over time, the patterns of behavior and qualities of interaction that emerge.

Along with Ashby and Walter, many of the early Cyberneticians including Norbert Wiener and Claude Shannon, built electro-mechanical models to study *self-organising behaviour*. While the singular *Watts Governor* may have symbolised the Cybernetic principle of circular feedback control, it was multiplicities of interacting feedback mechanisms, and their emergent self-organising behaviour that captured the pioneer's imagination. Emergence and Self-organization are essentially interchangeable terms in Cybernetics. While Self-organization saw less use beyond the field, Emergence had a wider although somewhat notorious philosophical position within the arts and sciences.

### **The Environmental Half**

Returning to the richness of Walter's tortoise behaviour, let's remind ourselves that the lifelike behaviour arose out of its relationships to its environment, whether from its encounters with mirrors, light sources, obstacles or another tortoise. An environment in the Cybernetic frame as "all objects a change in whose attributes affect the system and also those objects whose attributes are changed by the behavior of the system" (Hall & Fagen, 1956:20). From its first principles, Cybernetics implicitly recognises the behaviour of an agent-system is coupled to its environment. Whether it is in the study of the brain, or social or economic systems, behaviour does not occur within a vacuum, but rather is a continuous performative exchange with an environment.

*There can't be a proper theory of the brain until there is a proper theory of the environment as well. . . . the subject has been hampered by our not paying sufficiently serious attention to the environmental half of the process. . . . the "psychology" of the environment will have to be given almost as much thought as the psychology of the nerve network itself. (Ashby 1953: 86–87)*

I consider this to one of Cybernetics key contributions to understanding the sources of emergent life, intelligence and consciousness and it encourages us to rebalance our attention to design problems. Wherever one is engaged in crafting behaviour, from typical robotics markets

## Machine Life

through to emerging applications in architecture, arts and performance, the *environmental half* – which I will argue had been understudied – must be more fully considered.

The *environmental half* is a messy concept, and creates considerable challenges for designers. If an environment is the context in which an agent-system is intended or observed to exist within, then two observers may well have different ideas about what constitutes a given agent-system's environment. Ashby's Black Box construct, warns us that there may be things that are "out of view", and these may be of greater importance than we fully anticipate or appreciate. Where environments are incorrectly or under-defined, this can lead to potentially catastrophic consequences for a designed agent-system and indeed the environment it inhabits. This can happen at the scale of urban infrastructure projects as much as at the scale of nano-robotics. Such failures are mostly likely to occur when the authors of these systems become too confident that they have a complete understanding of the dynamics of their model. We only have to look back at the recent crash of international monetary markets in 2008 to show how quickly and catastrophically systems that are believed to be robust can fail. These are what Cybernetician Stafford Beer called "exceedingly complex systems", one that are impossible to know and control fully (Beer 1959:12) and which necessitates a type of design strategy that accepts inherent fallibility in the model.

A growing reliance on discrete computational – inherently incomplete – models in the design industry are developing presently with worryingly minimal concerns for the *environmental half* to use Ashby's phrase. In 2013, I organised and chaired the *Smart Geometry: Constructing for Uncertainty* conference at the Bartlett, to interrogate what I perceive as a flawed and potentially damaging ideology of reliance on these systems – whether they're at the scale of parametric urbanism, building information modelling, or space syntax. As the debate on the use of discrete computational models in architectural design is still in a process of maturing, we are better served by examining the fields of computer science, and artificial intelligence that have wrestled with the theoretical and technical challenges of *messy* complex and continuous-physical environments for over half a century.

Whereas Cybernetics conceived of intelligence as a continuous embodied exchange between agent-system and environment, A.I research, built on the binary logic of computing science, took the view that intelligence exists entirely in the computer's brain. Intelligence was disembodied rather than in concert with its environment. This Cartesian dualism led to what Stevan Harnad called the "Symbol Grounding Problem" (1990), where engineers had made great progress in highly structured symbolic environments such as chess games, but struggled to build computer controlled robots able to achieve even the simplest of navigational tasks in physical environments. Rodney Brook's *Elephant's Don't Play Chess* published in 1990 was one of a number of scathing critiques that emerged leading to a revival of the non-cognitive and nonrepresentational forms of embodied intelligence characteristic of early Cybernetic devices.

## A Behavioural Approach

The value in revisiting these Cybernetic principles, that Brooks demonstrated through machines of his own such as Genghis (1989) is to remind ourselves where the *qualities* of life and intelligence can be abundantly found without resorting to computationally heavy processes. Nature after all was not full of intelligent forms of behaviour by animals with minimal neural capabilities. As social scientists Herbert Simon pointed out in *The Sciences of the Artificial* (1969/1996 : 52) “An ant, viewed as a behaving system, is quite simple. The apparent complexity of its behavior over time is largely a reflection of the complexity of the environment in which it finds itself.”, he goes on a page later to argue that human behaviour is also “largely” explained by the same principle.

What Cybernetics argues so compellingly for is an equality of design opportunities in designing environments as well as in designing agent-systems to occupy them. It also provides a coherent and holistic theoretical framework for studying behaviour. The inherent unpredictability and the emergent novelty to be found in designing behaviour in concert with its environment has important implications for design that are under-appreciated in Architecture but appear essential to understanding the mechanisms and possibilities of a future living architecture.

## References

- Ashby, W. R. (1956) *An Introduction to Cybernetics* (New York: Wiley).
- Ashby, W. R. (1953) “Homeostasis,” in H. von Foerster, M. Mead, and H. L. Teuber (eds.), *Cybernetics: Circular Causal and Feedback Mechanisms in Biological and Social Systems: Transactions of the Ninth Conference* (March 20–21, 1952)
- Beer, S. (1959) *Cybernetics and Management* (London: English Universities Press).
- Brooks, R. A. (1990). Elephants don't play chess. *Robotics and autonomous systems*, 6(1), 3-15.
- Gregory, J. (1927). *The Animate and Mechanical Models of Reality*. *Philosophy*, 2, pp 301-314.
- Glanville, R. (2002). Second order cybernetics. *Systems Science and Cybernetics*, 3, 59-85.
- Hall, D and Fagen, Robert E. (1956), "Definition of System", in: *General Systems*, Vol. 1 (1956). p. 18-28;
- Harnad, S. (1990) The Symbol Grounding Problem. *Physica D* 42: 335-346.
- Heisenberg, W. (1958). *Physics and philosophy: The revolution in modern science*.
- J. Craig Venter Institute, (2010). *First Self-Replicating Synthetic Bacterial Cell*.
- Simon, H. A. (1996). *The sciences of the artificial*. MIT press.
- Venter, J.C. (2012) 'What is Life? A 21st century perspective', EuroScience Open Forum, Trinity College Dublin. Thursday 12th July 2012, viewed June 2015. Available online <https://www.youtube.com/watch?v=qi2MhsUSu0U>
- Walter, W. G. (1950a) “An Imitation of Life,” *Scientific American*, 182 (May), 42–45.

# Parametric Design as a Design Tool for Adaptive Reuse in Interior Architecture

*Studying daylight simulation and shading devices for enhancing building performance*

**Sarah Mansour**

Alexandria University

Faculty of fine arts

Alexandria, Egypt

nizayamer@hotmail.com

**Abstract:** This paper is presenting an investigation about using parametric tools and its efficiency to be used as an assistant factor in the terms of adaptive reuse for old abandoned sites on the interior architecture scale. This is complementary part from my Ph.D. thesis. The site location of the study will be “Kafr Ashri at Mina El pasal Old Train Station, Alexandria Egypt“. The study will deal with the integration of daylight analysis tool with the design process enhancing the sustainability matching with the style and nature of the site .Moreover to reach the optimum solution of a digital fabrication and prototyping proposal for a building ceiling retrofit which has been totally demolished. The main objective was to use parametric simulations and modelling to conduct design decisions, as an aid to the new transformed function for the main building in this train station to be art platform. Considering being a focal point to revive and maintain the history, character and skyline of the city. It will be a more sustainable and rational approach towards the conservation and reuse of heritage.

**Keywords:** *Adaptive reuse; Daylight simulation; Parametric design tools; Sustainability.*

## 1. Introduction

### 1.1 Background and Motivation

*"It is not the strongest of species that survive, nor the most intelligent, but the one most responsive to change "Charles Darwin".*

Nowadays, in a global context. adaptive reuse has evolved into a strategy to reconnect with heritage, address all tangible and intangible values of a place and give new life to community. It is an approach that is not only connected to *economic* benefits and is not reduced to the scale of one single building.

The reuse of existing buildings often becomes a tool to attract both future users, and possible investors, as well as to densify areas and create vibrant living environments. (1)

Adaptive reuse explore successful design approaches for visible interaction between new and old architectural styles, and to illustrate these approaches using and apply parametric design tools in case study (kafr Ashri at Mina El pasal Old Train Station) indicating the interventions

potentials to old buildings. These interventions will feature the interior alterations, as well as additions fused to the original building. The common thread among the designs selected is a thoughtful and clear vision of how new can interact with old. (2)

The main motivation refer to both the vital location (In the middle of the old city ,the currently wasted void connected to the city's urban fabric. via Alexandria port, main streets, Mahmoudeya Canal, monuments landmarks, etc.), Fig 1 & 2 adding to its historical value, as it is claimed to be the oldest train station in the middle east.

## 2. Same space, different function, cutting edge technology

Since society is under a continuous evolution, the need of adapting and reusing buildings to fulfil different functions is a necessity for future architectural projects. The evolution of human activities has influenced the way spaces are designed. Not only to fulfil a specific purpose, but to embody a series of different configurations. The flexibility of a space can provide a higher value for the building, as it can adapt to future needs. Due to the constant evolution of technology, the architectural space gains new principles and possibilities regarding its configuration. The space becomes an adaptable and flexible element, capable of changing its function in correlation with the necessities. (3) Hence the notion of using Parametricism as a design strategy to INVESTIGATE the space using relationship between the tools used and the way we understand space, and therefore the way our mind engages the creative process of designing, is a constant dialectic and dynamic process. (4)



Figure1.picture of the site accessibility "Work of year 3, Architecture dep. Alexandria university, faculty of fine arts, design studio, second semester 2014/2015.



# Parametric Design as a Design Tool for Adaptive Reuse in Interior Architecture

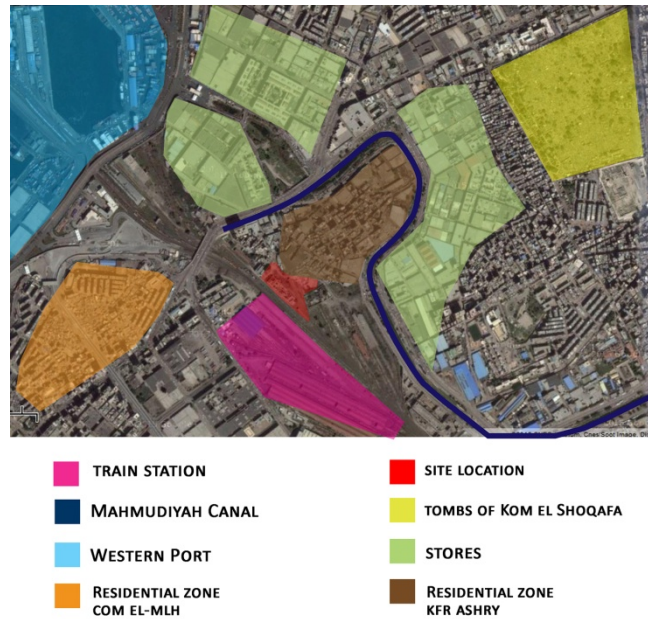

Figure 2. picture of the land-use "Work of year 3, Architecture dep. Alexandria university, faculty of fine arts, design studio, second semester 2014/2015.

## 3. Parametric design strategy

### 3.1 Objective

Resolving the demolished ceiling and the possibility of applying a screen system for façade too, adaptable to the daylight and the weather data conditions, using parametric tools. Adding to develop material suggestions to adapt to the existed materials, besides being a smart, sustainable one with many alternatives. Not to be oblivious for the aesthetic side of the parametricism, as it could be an effective optical and functional stimulant. If Generative system allow designer's creativity to redefine shapes, forms, configurations and organization system as relational, it's also reflects a new aesthetic, the aesthetics of relations or the aesthetic of sublime. (5) Fig.3.

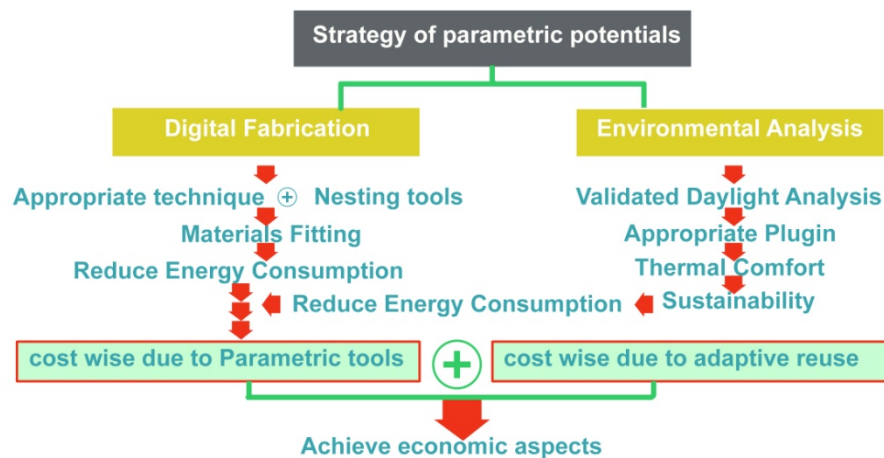

Figure 3. shows the design strategy that leads to fulfil economic aspects. Author work

### 3.2 Process

In past few decades the interior space considered to be an extended part of the outer building envelope. But in the old heritage buildings it's a totally different situation. The intersection between the old parts and the new is a challenge as we might need to integrate a new inner envelope to the space just to maintain and preserve the existed condition of the building itself, and that's for the preservation terms due to the physical condition.

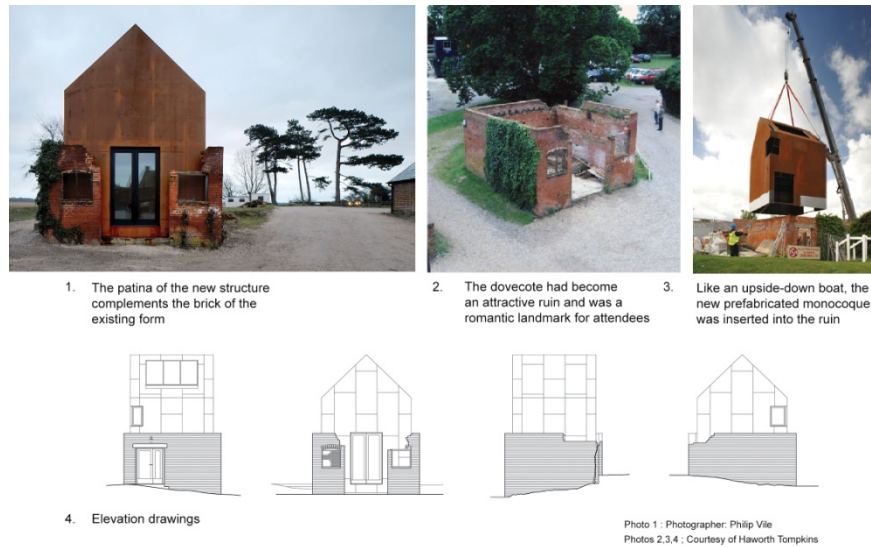

Figure 4. Shows the ruin previous parts of Dovecote Studio and after the intersection (6)

An obvious example was " Dovecote Studio". A redbrick building was run down and its roof had collapsed, it was an attractive ruin and a romantic landmark for attendees of the yearly Aldeburgh music festival, UK.Fig.4

Inserting new volumes and installations in the inner envelope add an enhancement and control the space .As the motives for adding a significant new form to a building vary widely, ranging from the need for more floor area to the complete reworking of the interior to accommodate a new program. A large addition to a building, however, substantially alters the visual perception of the site as the new hybrid takes on a character very different from the original. (7)

## 4. Design Challenge.

### 4.1 Adaptability criteria

Adaptability is obviously a key attribute of adaptation. It can be defined as the capacity of a build-ing to absorb minor and major change (Grammenos and Russell, 1997). (8) The motivation for the case study, the site we have many strength points such as; the building is historical, the spaces are vitiated between large – Medium – Small in areas, moreover the building contains steel structure – bearing wall structure and light structure. Fig5.

## Parametric Design as a Design Tool for Adaptive Reuse in Interior Architecture



Figure 5. Shows the site of study and its existed condition (9)

### 4.2 Generative performative design

The parametric tools will intensify and invigorate the design potentials, adding more tolerance and adaptability due to availability of initials design prototyping and optimize the most distinctive solution fitting with the building condition. As sometimes the physical condition of building fabric cannot sustain any accidental miss. Fig 6.

The area of study will be the main exhibition hall in the art platform, depending to insert a new volume into the midst of the patio and between the arches, represented as a temporary installation in a pavilion form, which could be changeable according to the events. Fig7. as the silhouette of the new addition matches with the outline of the Victorian style of the building.

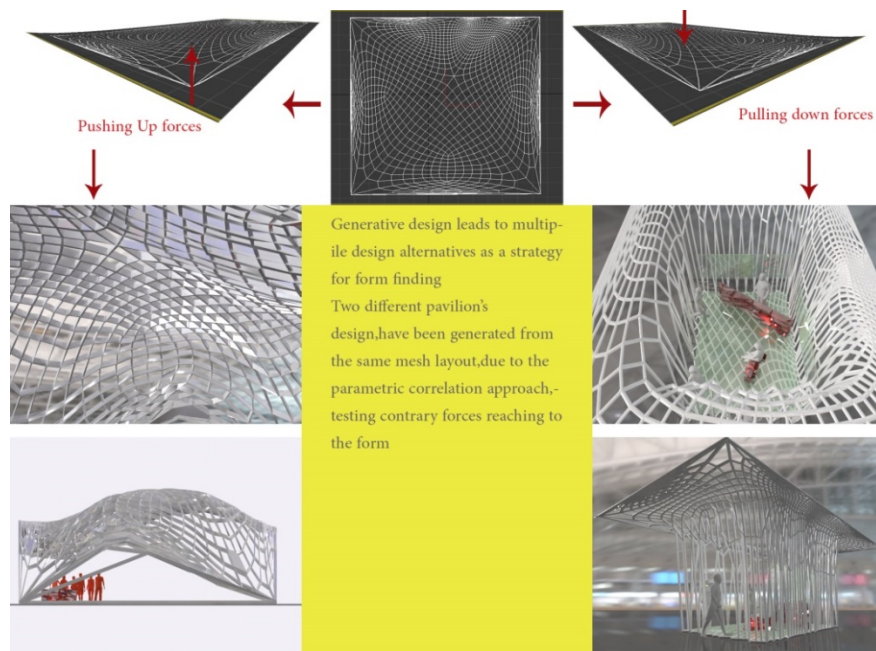

Figure 6. Form finding study .Author work



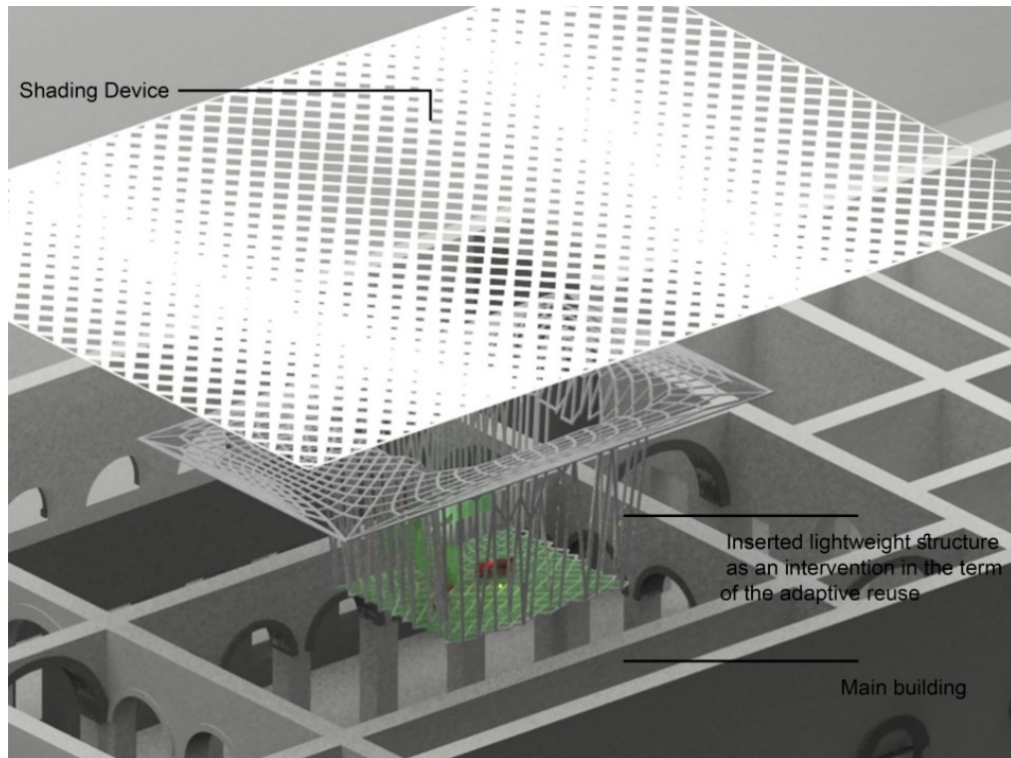

Fig 7. Inserting a new structure into the aged envelope to be used as the main hall for the new space function “exhibition hall”. Author work

## 5. Daylight study.

By creating a skin as a shading device for the devastated ceiling, another parameter considered was the light filtering effects of the apertures on the space occupants. One way to think about achieving this was by creating light channels into the space. The element of light poses as a significant factor in the way it interacts with structural forms. The spotlight of the sun will enhance the aesthetics of the structure through the reflection of it onto the surface and the appeal in distortion and manipulation when direction becomes involved. With the addition of perforations and apertures, this will allow for maximum exposure through the layer, and therefore reflecting intriguing shadows for greater aesthetic appeal. (10) Fig 8.

Developing ceiling pattern using grasshopper to generate design based on curve attractor definition, to enhance the building performance, Diva for Rhinoceros has been used for the daylight analysis simulation which based on Daylight Grid Based, illuminance metric “Point-in-Time Illuminance”, with clear sky condition with sun. Minimum illuminance was 300 lux, and the maximum simulation was 3000lux. By running two different simulation before and after applying the shading device over the space roof.

## Parametric Design as a Design Tool for Adaptive Reuse in Interior Architecture



Figure 8. The effect of the perforated shading device in manipulating with the natural daylight and the shadow that have been created in the space, adding to allow more natural ventilation using outdoor thin fabrics like ETFE. Author work

Analysing the daylight simulation results, it's totally clear that before applying the shading device over the building, that 97% of the space area are above 3000 lux, which is considered to be over lit, while the percentage has been totally changed after the design solution to configure that 79.2% of the space area is between 300&3000 lux, 18.5% of the area is more than 3000 lux, and 2.3% of area is below 300 lux. Remarkable difference between the results to enhance the building performance driven design approach which *used to input for parametric control of geometric model elements.* (11) Fig9.

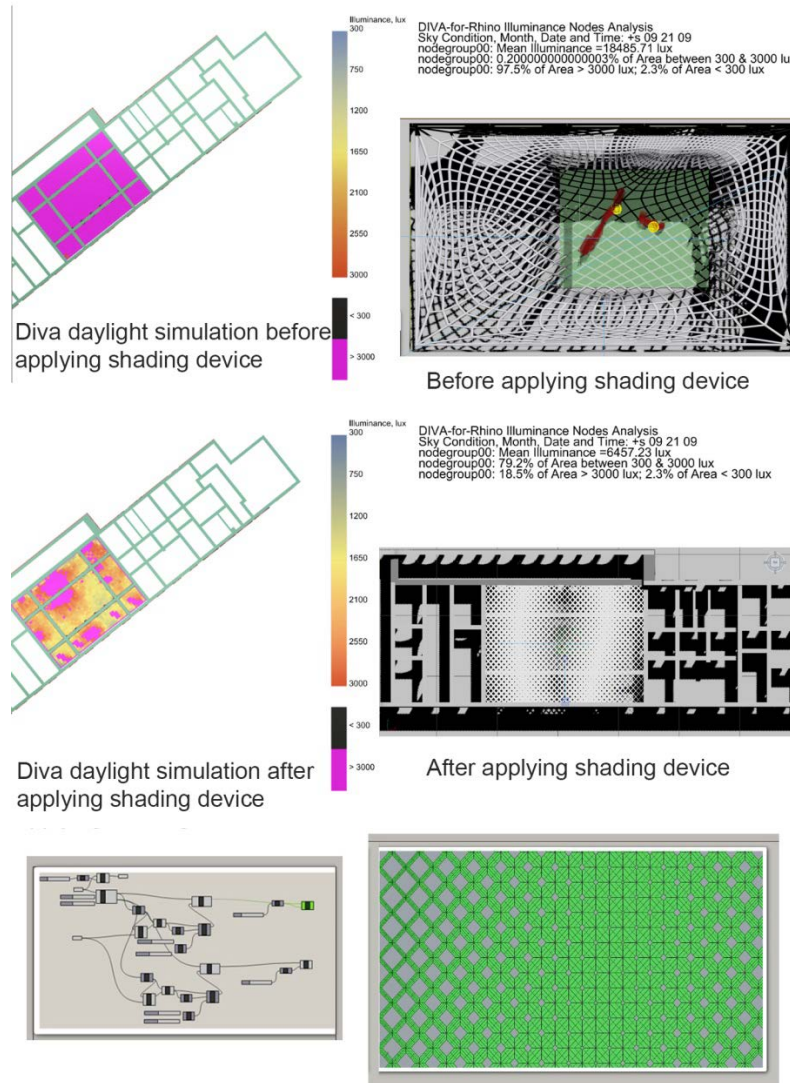

Figure 9. Diva simulation analysis. Author work

## 6. Fixing and Material Experimental design.

Suggested sustainable material like palm leaves mat, come in sheets (4\*2.5m<sup>2</sup>) allow transmitting light due to the weaving ability of the material nature. Fixed by electrical horizontal roller shutter. The shading device could be double layer, creating overlapped design and different alternatives. Fig10.



Figure 10. Transmitting light from palm leaves mat. Perforated, different, overlapped layers, give many different parameters. Author work.

# Parametric Design as a Design Tool for Adaptive Reuse in Interior Architecture

## References

- (1) Anagnostopoulos, Ioannis and Lampropoulou, Angeliki, (June 2015), Design for Sustainable Development, SK.Future adaptive reuse in the SKF quarter in Gamlestaden, Goteborg, Master thesis at Chalmers university Architecture department, p:13. Available on [https://issuu.com/johannes.anagnostopoulos/docs/skfuture\\_-\\_adaptive\\_reuse\\_in\\_the\\_sk](https://issuu.com/johannes.anagnostopoulos/docs/skfuture_-_adaptive_reuse_in_the_sk)
- (2) Bloszies, Charles, Old Buildings, New Designs. Architectural transformation, 2012, Princeton Architectural Press, 1<sup>st</sup> edn, p:25, downloaded from: <https://issuu.com/vladimirchuzhinov/docs/oldbuildings>
- (3) Dragan, Marius-Bogdan, ( March 201 ), Reuse London's industrial heritage, dissertation, Department of Architecture University of Strathclyde Glasgow, p:41 available on [https://issuu.com/mariusbogdan/docs/dragan\\_marius\\_dissertation\\_final/1](https://issuu.com/mariusbogdan/docs/dragan_marius_dissertation_final/1)
- (4) Tedeschi, Arturo, (2014), AAD\_ Algorithms -Aided Design. Parametric strategy using Grasshopper, 1st edn, 3.p:293.
- (5) Tedeschi, Arturo, (2014), AAD\_ Algorithms -Aided Design. Parametric strategy using Grasshopper, 1st edn, p:293.
- (6) Bloszies, Charles, Old Buildings, New Designs. Architectural transformation, 2012, Princeton Architectural Press, 1<sup>st</sup> edn, p 69,70 downloaded from <https://issuu.com/vladimirchuzhinov/docs/oldbuildings>
- (7) Bloszies, Charles, Old Buildings, New Designs. Architectural transformation, 2012, Princeton Architectural Press, 1<sup>st</sup> edn p.95 downloaded from <https://issuu.com/vladimirchuzhinov/docs/oldbuildings>
- (8) Douglas, James, Building adaptation, (2006) Heriot-Watt University, Edinburgh, UK. 2nd edn, p.33. downloaded sample, [http://samples.sainsburysebooks.co.uk/9781136425103\\_sample\\_895099.pdf](http://samples.sainsburysebooks.co.uk/9781136425103_sample_895099.pdf)
- (9) Photographer: Architect-Mohammad Elgohary.
- (10) WYNDHAMeGATEWAY PROJECT, Design Journal p.10,12. Downloaded from; [https://issuu.com/mitch\\_23/docs/journal\\_export/1](https://issuu.com/mitch_23/docs/journal_export/1)
- (11) Perkins+will, Re-Skinning: Performance-Based Design and Fabrication of Building Facade Components, research journal, 2012 / VOL 04.01, p;20, downloaded; 04.01.p.20 [http://www.perkinswill.com/files/ID%20\\_PWRJ\\_Vol0401\\_02\\_Re-Skinning%20Performance-Based%20Design%20and%20Fabrication.pdf](http://www.perkinswill.com/files/ID%20_PWRJ_Vol0401_02_Re-Skinning%20Performance-Based%20Design%20and%20Fabrication.pdf)



# Choosing The Material for Environment Responsive Screen Ray:

*The LCA comparison*

**Marie Davidová**

*Faculty of Art and Architecture,  
Technical University of Liberec*

*Prague, Czech Republic*

*Marie.davidova@tul.cz*

**Vladimír Kočí**

*Dept. of Environmental Chemistry,*

*University of Chemistry and*

*Technology Prague*

*Prague, Czech Republic*

*vlad.koci@vscht.cz*

**Abstract:** Wood performs based on its material properties by shrinking, expanding or warping due to the changes in relative humidity and temperature. This property intends to be utilized in architecture for purposes such as ventilation or thermal comfort. This concept was developed in the design of Ray 2, a screen that airs in dry and is resistant in humid weather. Two material options are available. Following the contemporary research, a plywood could be used performing on 'bi-metal' principle of different shrinkage of different wood species. In reference to the past, the tangential section applied in traditional Norwegian panelling, where different fibre density on opposite sides of the plate cause warping was proposed for the prototype. The plywood research shows better programmability. However, our paper claims that the use of solid wood, at least in the Czech context for the particular product of Ray 2, is more sustainable and therefore it is in our best interest to explore past knowledge in the field. The data from the local manufacturers, as well as from the related universities, were utilized to compare both of the cases in LCA analysis among all showing the energy savings and lower carbon emissions for solid wood.

**Keywords:** *Performance Oriented Architecture; Responsive Wood; Life Cycle Computer Modelling; Simulation Of Production Complexity; Solid Wood Versus Plywood; Sustainability.*

## 1. Introduction

Wood is the main renewable and recyclable building material that has been tested over generations, though administratively rejected due to the fire issues in many countries. Our study compares two ways of its use for design of performative screen Ray 2 that reacts to relative humidity and temperature of the environment. It is worth noting that no analysis is able to predict the future and account for all the circumstances. However, we decided to compare solid wood and plywood material in LCA analysis for this particular design. The screen is designed to be used on buildings and therefore is not a conventional product. This difference for Life Cycle Assessment is explained by Bribián et al., stating that LCA was mainly targeted at other low environmental impact products than buildings. Reasoning the difference in long life span, frequent changes, multiplicity of functions, inclusion of many different components, local production, uniqueness, causing of local impact, integration with infrastructure, unclear system boundaries, etc. (Zabalza Bribián et al. 2009). All these facts have to be taken in consideration when discussing our results and utilized data. Our focus was in the comparison of two materials for one

## Choosing the Material for Environment Responsive Screen Ray: The LCA Comparison

product in a certain location over an established period of time. The following summary explains the application for both of them.

### 1.1 State of art

While the current research in the field has been conducted on laminates or plywood, the traditional architecture was applying solid wood, cut in tangential section, for the performance. Therefore the paper's research question is which approach is more sustainable for the particular first author's design in certain location.

The natural property of wood is warping. When the material is cut in the tangential section it generates a so-called 'cup' across the grain (Knight 1961). Humidity responsive panelling systems based on the tangential section used in traditional Norwegian architecture were described by Larsen and Marstein:

'The boards are nailed towards the upper edge, just below the joint where they overlap. In dry weather, the lower board ends bend outwards, allowing dry air into the construction. In wet weather the boards close again.' (Larsen & Marstein 2000)

The first example in today's research, when the installation of Asif Amir Khan illustrated pine wood laminate-humidity interaction at the AA School of Architecture under the supervision of Michael Hensel and Achim Menges under Morpho-Ecologies project (Hensel & Menges 2006). The prototype provides more extreme performance in the organisation of the system towards openness and closeness, also showing the relation of scale/size in two directions. A Master thesis of Linn Tale Haugen supervised by Michael Hensel at the Oslo School of Architecture and Design proposed a way more durable plywood, performing on the different shrinkage of plies of different wood species (Haugen 2010). Ray 2 (see figure 1), the design by the first author, returns to the roots of Norwegian traditional panelling.



Figure 1. Ray 2 – Prototype after Three Years of Being Exposed to Weather (photo: Davidová 2016)

It uses the fact observed on the samples that the tangential cut panels in the shape of triangles warp twice as much as squares. The system was explained as:

'.... wooden environment responsive screen system that reacts to changes in relative humidity. Based on the material properties of wood cut in the tangential section, the system opens in dry weather, thus airing the construction, whilst in the humid conditions it closes, not allowing the moisture into the structure.' (Davidová 2014)

This refers to Berger et al. (Berger et al. 2015), stating that moisture has an impact on the indoor air quality and the hygrothermal comfort of the building's occupants. From their observations on laminates, Holstov et al. (Holstov et al. 2015) conclude and suggest that the thickness of the active layer (means wood) is also the main factor affecting the response speed. Composites with comparatively thick active layers can be applied where the response to longer term changes in the surrounding conditions is required (i.e. daily, monthly or even seasonal changes), whilst thinner composites can react rapidly to hourly changes of ambient humidity or sudden rain. The thickness of the panels was selected at 0.8 cm as a compromise between amount of warping and reaction speed contra durability of the panel.

Samples observations prior to the decision were made hourly within 24 hours with the changes ranging from 10% to 90% RH on plates with the thickness of 0.3; 0.5, 0.8 and 1 cm when 1cm was considered to perform too little and too slow and 0.5cm was considered too fragile during the summer storms.

## 1.2 Conclusion for Material Selection Chosen for Comparison

This resume shows that current research at the other institutions has been done on laminates and plywood. Compared to the laminates, the plywood seems to be much more durable when it comes to vandalism, as it can combine the directions of the fibre. The laminates are very thin veneers with textile laminates that break very easily. Therefore, the plywood option was used for comparison with solid wood in Life Cycle Assessment analysis on the case study of the Ray 2 concept.

From the forest analysis of Central Bohemia, where the research is located, it became reasonable to use the combination of pine wood and false acacia. The solid wood model comes from pine wood. Pine wood is native to Central Bohemian forests (or Czech forests in general, as it grows there in all the places with low nutrients), therefore it is good to support its growth and harvest. At the same time it has very high performance when it comes to warping in the tangential section. On the contrary, false acacia is a dangerous, invasive species with no local enemies. False acacia should be harvested and its roots excavated, as it is the way it reproduces, poisoning the soil, thus disabling natural biodiversity. Pine wood and false acacia have reasonably different tangential shrinkage, therefore its veneers would perform well on the concept of so called 'bi-metal'. As a result, the species for both of the Ray 2 concept products were chosen, on one hand for its suitable material properties, on the other hand for its positive impact on local ecosystems with low carbon footprint during its transportation.

## Choosing the Material for Environment Responsive Screen Ray: The LCA Comparison

The speculation of the advantages of solid wood considered the energy and carbon emissions, but also the evaporation of poisonous chemicals. As Wójcik & Strumillo puts it:

'Today, remanufacture of timber, i.e. the production of timber derived sheet components and glulam beams, is a way to meet the needs of modern economy. That is not without an impact on the environment. Processing a material means energy expenditure and may have an impact on health risks posed by this material, and also on its recycling.' (Wójcik & Strumillo 2014)

### 2. Method - LCA:

The methodology of life cycle assessment used in this project was based on ISO 14040 (Anon 2006a) and ISO 14044 (Anon 2006b) with detailed specification according to EN15084 (Anon 2014), that can be used as product category rules for construction products. For detailed evaluation of environmental impacts, not only were impact categories required in EN 15804 was calculated, but additional impact categories based on USETox (Henderson et al. 2011) and ReCiPe (Goedkoop & and coll 2009) were calculated as well.

The aim of the Life Cycle Assessment based comparison of the panelling compared to the Ray 2 design concept was to evaluate environmental burdens and/or benefits of having the panelling made of solid wood and or plywood. The functional unit chosen was one square meter of panelling possessing its fully-functioning ability for a reference lifetime of 20 years. In this study, the Life Cycle Assessment was principally performed on the production of panelling, its application including repair, and finally on waste management and energy utilisation of used wooden parts. Used system boundaries include wood production and atmospheric CO<sub>2</sub> utilisation and incorporation into wood biomass, panelling production, transportation, production of the ancillary materials and energy carriers, consumption of fuel and water, as well as atmospheric, aquatic, and soil pollution produced. The end-of-life phase of the panelling Ray 2 concept was modelled as in solid wood and/or plywood-contained energy recovery and its use for avoiding emission related to the production of the same amount of thermal energy.

LCA methodology was used to calculate the possible environmental interventions (inventory profile) and characterisation profiles (results of impact category indicators) (Koci & Trecakova 2011). The pollution from diesel consumption and electric production, as well as the relevant processes dealing with polyurethane glue, were derived from use of the GaBi 6 Professional database (thinkstep).

### 3. Results and discussion

Outputs of inventory analysis are summarized for following modules of life cycle: upstream module; transport; core module; energy recovery and end of life (EoL) module. Within upstream module all processes dealing with production of materials and energy carriers are included. Transport module covers production of during transport consumed fuels and emissions dealing with transport within all life cycle. In core module in site manual production of Ray2 panels and its estimated repair during 20 years of use. EoL summarizes inputs and outputs within waste

management and Energy recovery demonstrate potential benefits of use of wooden parts as biotic fuel during end of life of panels.

Solid wood Ray2 needs a lower amount of all consumed resources and, in the case of the energy-carrying resources and water, avoids consumption of a higher amount of resources (expressed as numbers below zero). The main resource consumption is due upstream module and end of life module. Although during the core module there is principal consuming of Pine and/or False Accacia wood as a biotic resource.

The assessment of possible environmental impacts was conducted using CML IA. USETox characterization was used for evaluating toxic and ecotoxic impacts of both scenarios. The ReCiPe characterization method was used for sensitivity analysis.

Similarly as in the evaluation of resource consumption results in impact categories due to the energy recovery of end-of-life wood and plywood express negative values, meaning the positive effect on the environment- so called avoided emissions/impacts. As the values decrease, the amount of avoided emissions rises. It seems that both of the products would be truly sustainable as the environmental impact of wood and wood products in general seems to be lower than other materials used in the building industry. This has been also concluded by a literary study comparing the results for cca. twenty years in Europe, Northern America and Australia by Werner and Richter (Werner & Richter 2007). The LCA results argue for the use of solid wood with negative values in most of the categories. Therefore it seems that solid wood is more suitable for Ray 2 product for Czech Republic.

#### **4 Conclusions**

The experience of vernacular carpenters, accumulated throughout generations, has been overlooked during modern times and must be revisited through 'Research by Design' in transdisciplinary teams by samples observations and the construction of prototypes in 1:1 scale. The Life Cycle Assessment of wood and plywood panelling clearly demonstrated that solid wood-based panelling of Ray2 exhibits substantially lower environmental impacts than plywood, having lower results in almost all the values for the Czech Republic. This statement is valid for all applied impact categories and is not sensitive to the selection of impact assessment methodology. Therefore, research on performative wood should also consider the direction of solid wood.

From the designer's perspective, it is an important fact that Life Cycle Assessment is utilizing the most up-to-date data even for the calculations of the future and not the speculations of its possibilities. In this way, the system avoids failures of predictions in development, but on the other hand, it is unable to be precise in its life cycle nor accurate in the evaluation.

#### **References**

Anon, 2014. EN 15804:2014 Sustainability of construction works – Environmental product declarations – Core rules for the product category of construction products,

Anon, 2006a. ISO 14040:2006(en), Environmental management — Life cycle assessment — Principles and framework, Available at: <https://www.iso.org/obp/ui/#iso:std:iso:14040:ed-2:v1:en> [Accessed April 3, 2016].

## Choosing the Material for Environment Responsive Screen Ray: The LCA Comparison

Anon, 2006b. ISO 14044:2006 Environmental management - Life cycle assessment - Requirements and guidelines, Available at: <http://www.standardsbis.in/Gemini/scoperef/SRIO14044.pdf> [Accessed April 3, 2016].

Berger, J. et al., 2015. Factors governing the development of moisture disorders for integration into building performance simulation. *Journal of Building Engineering*, 3, pp.1–15. Available at: <http://www.sciencedirect.com/science/article/pii/S2352710215000212> [Accessed April 3, 2016].

CZU, 2016. Faculty of Forestry and Life Sciences, Czech University of Life Sciences in Prague. CZU. Available at: <http://www.fld.czu.cz/en/> [Accessed March 29, 2016].

Davidová, M., 2014. Wood's Material Performance: Ray2. In *Wooden architecture, tradition, heritage, present, future – Proceedings1*. Gdansk: Wydział Architektury Politechniki Gdańskiej za zgodą Dziekana, pp. 93–99.

Dřevostavitel, 2015. Hmotnost dřeva. Dřevostavitel. Available at: <http://www.drevostavitel.cz/nastroj/hmotnost-dreva> [Accessed April 3, 2015].

Eštoková, A. & Porhinčák, M., 2012. Reduction of primary energy and CO<sub>2</sub> emissions through selection and environmental evaluation of building materials. *Theoretical Foundations of Chemical Engineering*, 46(6), pp.704–712. Available at: <http://link.springer.com/10.1134/S0040579512060085> [Accessed April 3, 2016].

Gaudreault, C. et al., 2012. Life cycle greenhouse gases and non-renewable energy benefits of kraft black liquor recovery. *Biomass and Bioenergy*, 46, pp.683–692. Available at: <http://www.sciencedirect.com/science/article/pii/S0961953412002693> [Accessed April 3, 2016].

Goedkoop, M. & and coll, 2009. ReCiPe 2008: A life cycle impact assessment method which comprises harmonised category indicators at the midpoint and the endpoint level., Netherlands. Available at: [http://www.leidenuniv.nl/cml/ssp/publications/recipe\\_characterisation.pdf](http://www.leidenuniv.nl/cml/ssp/publications/recipe_characterisation.pdf) [Accessed April 3, 2016].

Haugen, L.T., 2010. *Shaping Wood*. Oslo School of Architecture and Design.

Heijungs, R. et al., 1992. *Environmental Life Cycle Assessment of Products, Guide and Backgrounds*,

Henderson, A.D. et al., 2011. USEtox fate and ecotoxicity factors for comparative assessment of toxic emissions in life cycle analysis: sensitivity to key chemical properties. *The International Journal of Life Cycle Assessment*, 16(8), pp.701–709. Available at: <http://link.springer.com/10.1007/s11367-011-0294-6> [Accessed April 3, 2016].

Hensel, M. & Menges, A., 2006. *Morpho-ecologies*, London: AA Publications. Available at: [https://scholar.google.com/scholar?q=intitle:Morpho-Ecologies&hl=en&as\\_sdt=0,5&scilu=8198627336292636716:1&scisig=AMstHGQAAAAVwDefIU6mMt6tBv0rn\\_ok0Y5t\\_y7BUaC&gmla=AJsN-F4hr4Nv6mVgFNEJeVlcMZgKSueIvN3KPUllWN3ekEi2xc7VAidixHpcL6934x\\_8pPyQCTYefp3QwKFc92KT0j\\_](https://scholar.google.com/scholar?q=intitle:Morpho-Ecologies&hl=en&as_sdt=0,5&scilu=8198627336292636716:1&scisig=AMstHGQAAAAVwDefIU6mMt6tBv0rn_ok0Y5t_y7BUaC&gmla=AJsN-F4hr4Nv6mVgFNEJeVlcMZgKSueIvN3KPUllWN3ekEi2xc7VAidixHpcL6934x_8pPyQCTYefp3QwKFc92KT0j_) [Accessed April 3, 2016].

Holstov, A. et al., 2015. Towards Sustainable Adaptive Building Skins with Embedded Hygromorphic Responsiveness. In O. Englhardt, ed. *Proceedings of the International Conference on Building Envelope Design and Technology - Advanced Building Skins*. Graz: Institute of Building Construction, Graz University of Technology, pp. 57–67. Available at: <http://lamp.tugraz.at/~karl/verlagspdf/advanced-building-skins.pdf>.

Knight, E., 1961. *The Causes of Warp in Lumber Seasoning*, Oregon.

Koci, V. & Trecakova, T., 2011. Mixed municipal waste management in the Czech Republic from the point of view of the LCA method. *The International Journal of Life Cycle Assessment*, 16(2), pp.113–124. Available at: <http://link.springer.com/10.1007/s11367-011-0251-4> [Accessed April 3, 2016].

Larsen, K.E. & Marstein, N., 2000. *Conservation of Historic Timber Structures: An Ecological Approach*, Oxford: Reed Educational and Professional Publishing Ltd.

Pawelzik, P. et al., 2013. Critical aspects in the life cycle assessment (LCA) of bio-based materials – Reviewing methodologies and deriving recommendations. *Resources, Conservation and Recycling*, 73, pp.211–228. Available at: <http://www.sciencedirect.com/science/article/pii/S0921344913000359> [Accessed February 29, 2016].

Slovak University of Agriculture in Nitra, 2016. Horticulture and Landscape Engineering Faculty, Slovak University of Agriculture in Nitra. Available at: <http://ww.uniag.sk/en/horticulture-and-landscape-engineering-faculty/> [Accessed April 3, 2016].

Werner, F. & Richter, K., 2007. Wooden building products in comparative LCA. *The International Journal of Life Cycle Assessment*, 12(7), pp.470–479. Available at: <http://www.springerlink.com/index/10.1065/lca2007.04.317> [Accessed March 17, 2016].

Wójcik, M. & Strumillo, J., 2014. BackToBack - A bio-cybernetic approach to production of solid timber components. In E. M. Thompson, ed. *Fusion - Proceedings of the 32nd eCAADe Conference - Volume 2*. Newcastle upon Tyne: Department of Architecture and Built Environment, Faculty of Engineering and Environment, Newcastle upon Tyne, pp. 159–168. Available at: [http://cumincad.scix.net/cgi-bin/works/Show?\\_id=ecaade2014\\_140&sort=DEFAULT&search=W%f3jcik&hits=2](http://cumincad.scix.net/cgi-bin/works/Show?_id=ecaade2014_140&sort=DEFAULT&search=W%f3jcik&hits=2) [Accessed April 3, 2016].

Zabalza Bribián, I., Aranda Usón, A. & Scarpellini, S., 2009. Life cycle assessment in buildings: State-of-the-art and simplified LCA methodology as a complement for building certification. *Building and Environment*, 44(12), pp.2510–2520. Available at: <http://www.sciencedirect.com/science/article/pii/S0360132309001188> [Accessed July 16, 2014].



## Experimental Rooms: Integration of parametric tools for designing spaces. Structure, light and sound.

*Magic Spheres*

**Kevin Moreno Gata**

*Universidad de Alcalá*

*Alcalá de Henares, Spain*

*Kevin.morenogata@gmail.com*

**Ernesto Echeverría Valiente**

*Universidad de Alcalá*

*Madrid, Spain*

*Ernesto.echeverria@uah.es*

**Abstract:** The progress in architecture design has always been connected to the contemporary technology innovation. This new techniques have been associated to every scale and elements that compound an architectural design. Nowadays, computer-aided technology, besides the advantages on display, computer graphics and artificial experimentation with architecture, also allows us to create structures and elements that would be very laborious and sometimes impossible to carry out without them. These methods accelerate the designing process by connecting the parameters that compose them, in a way that, if we modify them, we will not have to redo the initial design. In addition, these parameters are able to store information, transform it, and produce graphic variations.

The Experimental Room is a real architectural space, where the user can interact to transform the environment. The subject to present for the congress deals with the research and exposition of a project which seeks for the complete integration of all the parametric processes. The purpose of this project is to prove that, thanks to the architectural space parametrization we can assign real and virtual variations to modify his entity.

**Keywords:** *Parametric Design; 3d Printing; Programming; Interactive Architecture; Virtual Reality.*

### 1. Introduction

Parametric structures not only allow us to configure spaces creating structures with mathematical developments, we can also build prototypes quickly using machining systems. It is also interesting include external factors as other design parameters, such as light, movement and sound, capable of being measured with digital tools and being participants in the design.

For the design and production of the pavilion it has been used tools and open source software like Grasshopper, Firefly, Arduino®, Repetier-Host and 3D printers using prototyping system of RepRap printers.

Currently "Experimental Rooms" is a research project that it is being conducted at Universidad de Alcalá, in the department of Graphical Representation, thanks to the scholarship program: "Introducción a la Investigación".

## 2. Precedent

Experimental Room belongs to the Magic Spheres series (Figure 1), proposals designed to be implanted in the cities by way of pavilions or temples of the new contemporary society where people could increase the relationship with architecture.

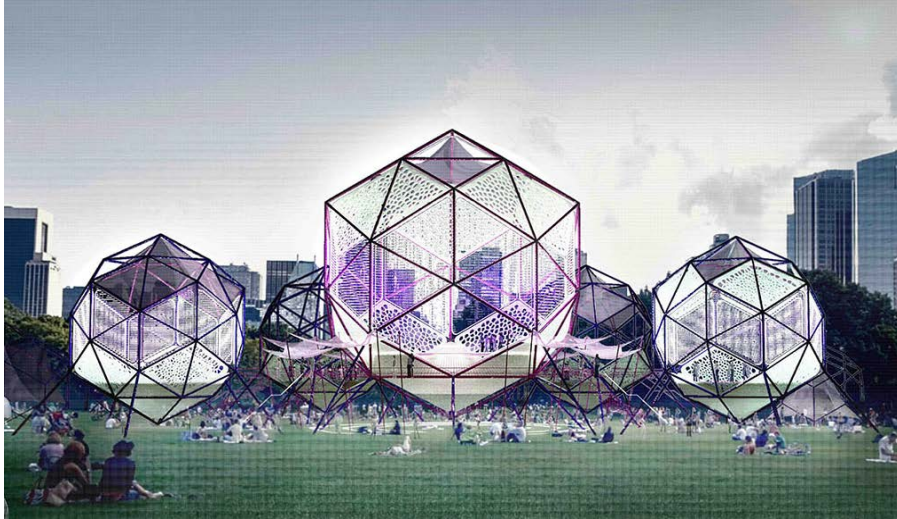

Figure 1. Magic Spheres. Utopian Pavilion which integrates all parameters.

However creating spaces for experimentation is closely related to the Expressionism of early 20<sup>th</sup> Century (Figure 1). Overlapping layers facades manages to create different optical illusions. These utopias are examples of experimental spaces whose function is also to be monumental and increase the perceptions with architecture.

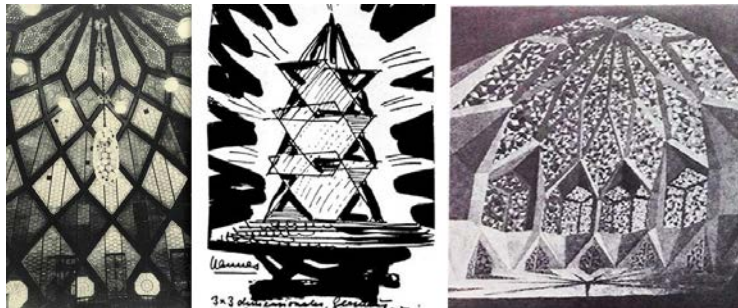

Figure 2. From Left to Right: Taut, B., 1914. Glass Pavilion, Cologne; Scharoun, H., 1920, Three Dimensional Glass House; Luckhardt, W., 1920.

The Magic Spheres are compounded of self-built structure (Figure 3) that may vary with different panels witch cover the space: Textiles, translucent walls and LED screens. The latter are the most characteristic elements: the LEDs are mounted on a fine sub-structure, so that during the day, are turned off and it is possible to see through. In the evening, on the contrary, the pavilion lights and the user can experience a virtual environment of light and sound.

## Magic Spheres

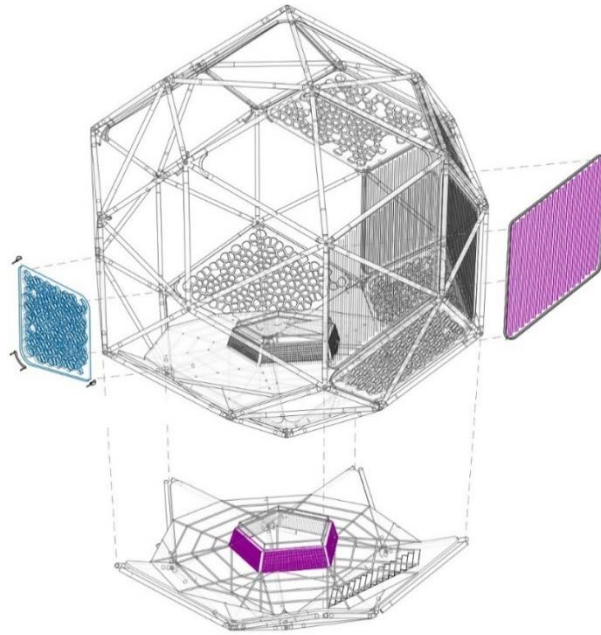

Figure 3. Structural composition of the proposed pavilion.

### 3. Geometry

The designed prototype is a sculpture 1:5 scaled of the original designed pavilion as a lamp that illuminates the space where it is placed.

The initial geometry is a Rhombic Triacontahedron, from the polyhedron family of Catalan Solids. Through a parametric design, based on its mathematical definition the structure is achieved. Tensioners are added in half rhombi to complete an isostatic structure.

The sculpture is designed to be suspended from its apex hanged with a cable (Figure 4). The side panels correspond to vertical surfaces where lighting panels are incorporated. It is a digital skin. In a dark space we see this geometry, a temporary and intangible space.

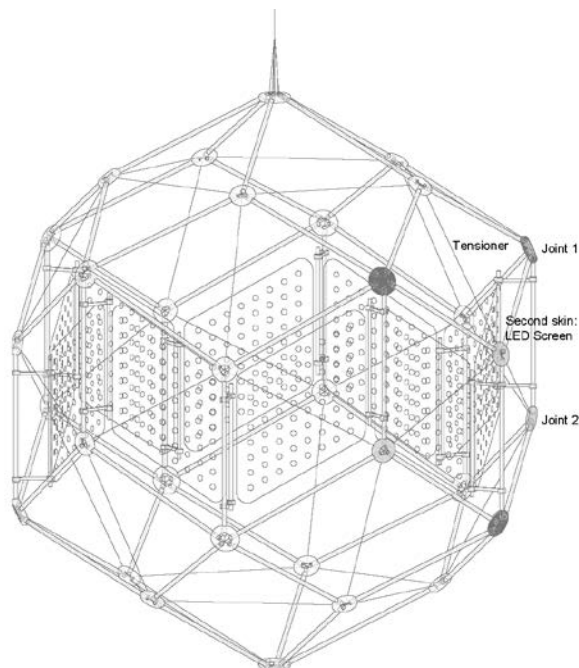

Figure 4. Final Structure



Figure 5. Building Process

## 4. Fabrication process

### 4.1 Structure design

Taking the initial polyhedron the structure is designed totally parametrised. In addition an algorithm allows to vary the dimensions of all the pieces, due to production tools, like 3d printers or CNC milling machines, could have different resolution. Therefore it could be fabricated almost everywhere.

### 4.2 Production.

For the structure they have been used threaded steel rods, 3D printed joints in ABS plastic and nylon thread for tensioners.

The joints seek optimization design with a minimum resolution that a 3d Open Source Printer could give (Figure 6). They are designed as rings which screw the steel rods, leaving enough space to adjust the length or to introduce another rods in complex positions (Figure 10).



Figure 6. Printing Joints.

### 4.3 LED Screen Panels.

As an inner skin, 640 LEDs in 10 different panels (Figure 8) form the virtual space of the project. With a printed mould (Figure 7) the LEDs are placed for the correct position and welded with each other getting a small 8x8 matrix.

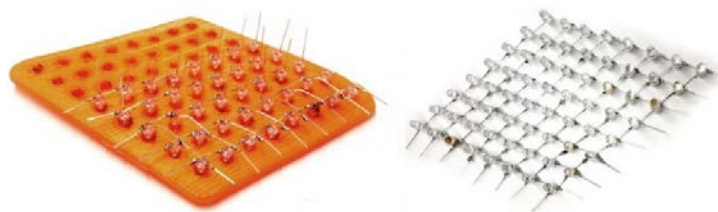

Figure 7. Printed mould and LED matrix panel.



## Magic Spheres

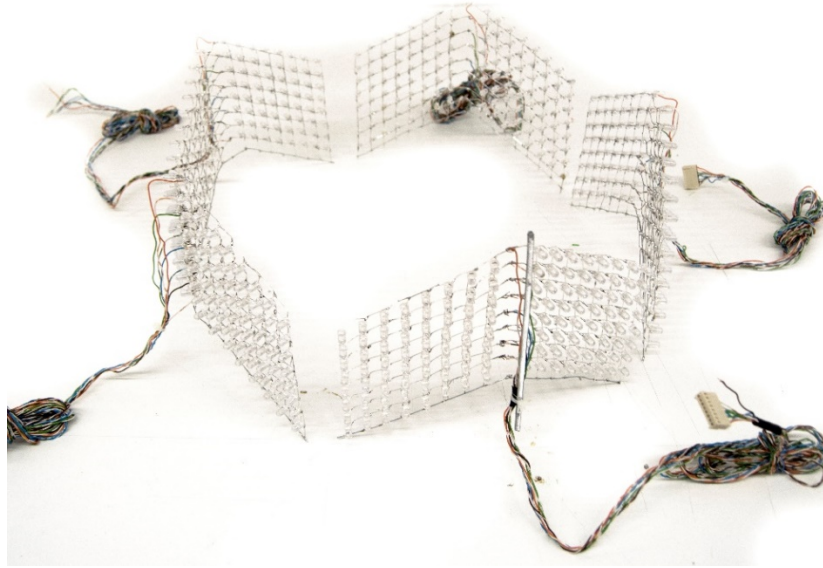

Figure 8. LED Panels

### 5. Graphic simulation.

According to a parametric design, these LED displays are set as another parameterized element that could be controlled in real time. These screens are connected to a micro-controller board (Arduino©). This open source tool can be controlled from his own programming software or with the same parametric design program: Grasshopper with Firefly. With them it can assign geometric parameters mixed with programming tools like C # script or VB.NET script. Additionally it is used a motion sensor (Xbox Kinect©), which enables to select geometric points of the human body. We can analyse that data to send information to Arduino and control the LED screens. On the other hand Firefly gives us the possibility to analyse other physical parameters such as sound or other movements using external tools.

A typical visitor starts to move him inside. Immediately the motion sensor transmits the changing state of the visitor in real time to the micro-controller, which regulates the LED screen in accordance to its spatial position at every instant. The actuated movement causes the appearance of a motion-related light configuration (Figure 9).

The actuation of such a relatively big structure and the intuitively understanding of its own dynamics, is joyful and satisfying. Finally, within the original concept, through this pixel screen the structure abstractly communicates with the visitor achieving a mimesis between people and architectural components, or between the individual and the city elements.



Figure 9

## 6. Innovative applications.

To end, using interactive skins allows architects to redesign spaces, add new applications and design virtual spaces to show information or project other realities such as anamorphic effects. In addition, overlapping layers of graphic elements like digital skins changes the perception of living space producing immaterial effects through programming and creating walls where there are not.

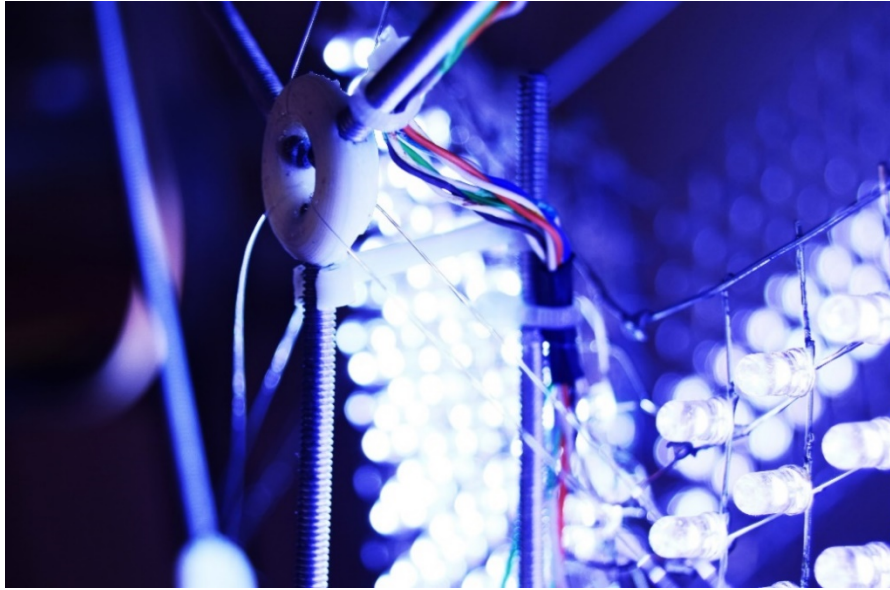

Figure 10. Detail of Joint 2. Tensioners tied in the knot and LED panels hanging from the structure. The cables are attached to the structure toward the apex.

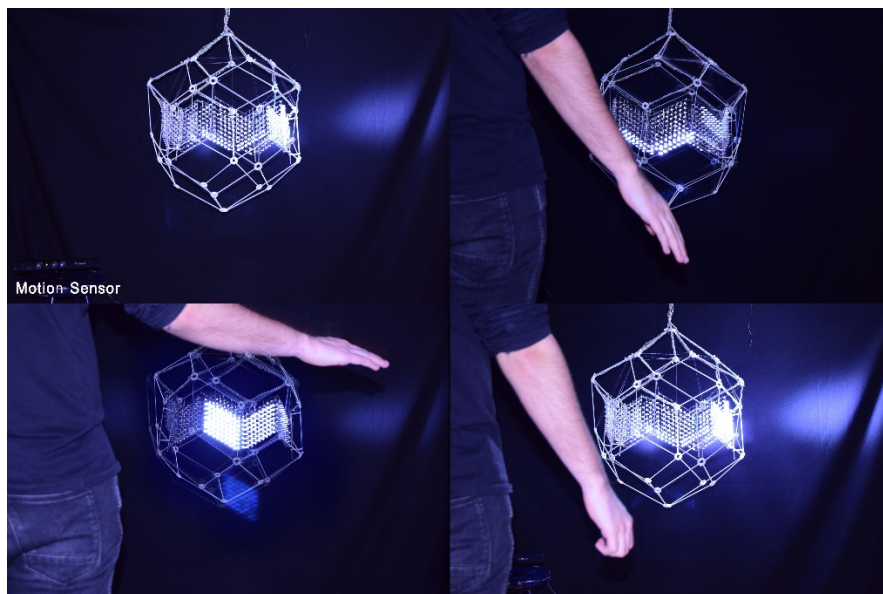

Figure 11. Motion sensor controlling the display.

## Magic Spheres



Figure 12.



Figure 13.

### 7. Energy Saving.

On the other hand, with the acquired knowledge of parametric tools, it is complementing another research project in collaboration with Universidad de Alcalá de Henares and financed by the “Ministerio de Economía y Competitividad”: ENE 2013-48015-C3-2-R, “Integrated energy optimization systems and CO2 reduction: BIM Technologies, Indoor Mapping, UAV and energy simulation tools.”, in which design strategies seek to find constructive solutions for energy savings in existing buildings.



## References

Climent Ortiz, J: 2011, Expresionismo. Lenguaje y Construcción De La Forma Arquitectónica; Biblioteca Nueva, 37-107.

Collado Arpia, M: 2012, De La Psicodelia A Las Cortinas Del Siglo XXI; Doctoral Thesis, Escuela De Arquitectura De Madrid, 303-354.

Ednie-Brown, P.; Burry, M. and Burrow, A.: 2013, The Innovation Imperative Architectures Of Vitality; Wiley.

Fortmeyer, R. and Linn, C.: 2014, Kinectic Architecture: Designs For Active Envelopes; Images Publishing.

Garcia, M.: 2014, Future Details Of Architecture; Wiley.

Sloterdijk, P.: 2004, Sphären III; Suhrkamp.

## Unfolding Ancient Architecture Through Low-Budget Virtual Reality Experience

**Guzden Varinlioglu**

*Izmir University of  
Economics  
Izmir, Turkey  
guzdenv@gmail.com*

**Gazihan Alankus**

*Izmir University of  
Economics  
Izmir, Turkey  
gazihan.alankus@ieu.edu.tr*

**Abstract:** In a field where conventional 2D drawings, sketches, and maps have been the norm, immersive VR technology can have a profound effect for architectural historians. Software, such as SketchUp, with little budget requirement and gentle learning curve has been an invaluable digital asset in creating 3D models, however, a combination of 2D and 3D with VR technology could prove to be the next frontier for architectural history research. With practically zero implementation costs and an immediate global network for real-time smartphone based collaboration, the future of the architectural past is the present.

Keeping this in mind, the aim of this paper is to discuss the impact of newly accessible low-budget VR tools on the work of architectural historians. The results showed that analysis and research for architectural historians can be streamlined by quickly developing a site-wide VR environment. Individual buildings can be compared with their surrounding terrain, contrasted with similar structures from other sites and with old illustrations of archaeologists. Groups of buildings can be checked for alignment and, where less archaeological remains are available, the VR view can hint towards filling-in the gaps.

**Keywords:** *3D Digital Reconstruction; Low-Budget Tools; Virtual Reality.*

## 1. Introduction

Architectural historians have used 3D digital documentation and reconstruction of sites and buildings since the introduction of information technology. More 3D data came into play with digital documentation tools such as laser scanners, photogrammetric models and total station. Easy-to-use 3D modelling applications have brought digitally reconstructed sites and buildings to the service of archaeologists. However, standard 2D orthographic projection drawings are still the norm, with plans, sections and elevations often coupled with hand-sketched illustrations to create 3D depictions in 2D format. Similarly, 3D models help historians advance their analysis, visualise historical scenes, and convey this information to the public. The Romelab Project, for example, uses hypothetical reconstructions within the Unity gaming platform to test the validity of competing reconstructions, and to challenge assumptions about how these spaces and places were used in Imperial Rome (Johanson 2009). The virtual reality (VR) experience, by means of immersion in 3D virtual space, is used in computer simulations for serious games. Kateros et al (2015), for example, present digital curations of heritage sites through VR experiences of serious game platforms in 3D digital reconstructions of the Roman Agora in Thessaloniki and the site of Knossos in Greece. Besides questioning the serious game platform, for non-entertainment purposes, they present 3D content creation pipelines showing how information technology is playing an active role in analysis for archaeologists. Until now however, there has not been a VR system capable of layering 3D depictions of ancient buildings with 3D models of existing conditions, overlapped and aligned with actual reconstructions of the scene.

A VR platform for overlapping archaeological and historical hand-drawn building reconstructions with new 3D digital reconstruction models can act as an analysis tool for the historians through VR. The fundamental idea is the design and implementation of a web-based collaborative platform for architectural historians through VR experience. The prototype that we developed allows historians to experience 3D reconstructions of ancient sites through the VR glass, to analyse and interpret their archaeological research of the site, while aiding research on similar buildings. They will also have the ability to share scenes constructed using 3D models to communicate their interpretations and to collaborate with other colleagues.

Presented in this paper is the initial stage of the Digital Teos project, an interdisciplinary research investigating and digitally animating the Teos excavation area. One of the more important cities of Ionia, the ancient city of Teos contains all the occupation levels from the Roman Period back to the Protogeometric Period. The temple of Dionysos, along with the bouleuterion, theatre, cistern and the south harbour, are the main focus of the archaeological research, as directed by Prof. Dr. Musa Kadioglu. The procedure begins with the translation of existing excavation data into virtual environments, whereby the archaeological area and buildings are modelled and presented through digital techniques. This is a preparation for manipulation within a serious gaming environment, as well as a digital support for on-going archaeological work. The digital techniques employed will enable a faster and more accurate documentation process. Following this approach, this project aims to create a digital resource of archaeological,

# Unfolding Ancient Architecture Through Low Budget Virtual Reality Experience

architectural, and cultural value that can actively contribute to the body of archaeological research for the general region.

## 2. Objectives

The aim of the work is to gain an insight into the impact of newly accessible low-budget VR tools on the work of architectural historians. To achieve this, we designed and coded a prototype web-based collaborative platform that archaeologists can use to communicate directly with digital modellers. The objective is for architectural historians to subsequently use these 3D models as interpretative tools. The first goal is to determine the research pipeline for construction of 3D digital models of the ancient architecture based on grammar and rules. The second goal is to design a collaborative VR platform where users combine reconstructed models for comparison with ancient archaeological illustrations and 3D photorealistic models. Based on orthographic drawings of the visible architectural remains, digital documentation of invisible parts underground, and illustrations by the archaeologists, rules and grammar (procedures) are determined to classify and reconstruct the architectural elements. Once converted into procedural units, the buildings are modelled using SketchUp. Reconstructed models are imported into the Unity gaming platform in low-polygon format and used in a VR application developed with the Unity game engine and Google Cardboard. The goal of this application is to enable historians to communicate and collaborate using digital 3D models of historic buildings and artefacts by quickly creating scenes of sites, structures or artefacts, and sharing them with each other and collaborating through incremental edits. Furthermore, existing pictures of the scene can be used as reference for camera placement. Such factors will allow this tool to dramatically improve the workflow of architectural historians, all while using an affordable technology.

## 3. Literature Review

### 3.1 Representation and reconstruction of space in 2D

Representation of space by mathematical rules of perspective is credited to Brunelleschi in the 15th century, for conducting a mathematical study of the laws underlying linear perspective, but Alberti was the first person to do so in writing for use by artists in his treatise on paintings. The problem of representing the real 3D world in 2D has engaged architects for centuries. In the 15th century, Dürer published a treatise on measurement, which included a series of illustrations of drawing frames and perspective machine (Wood 2002). The combined effort was to find a method of graphically representing an object as it appears to the eye by suggesting three dimensions.

The effort involved in depicting the real 3D world is further systematized in several technical drawing standards in archaeology. In their technical guide on archaeological illustration, Adkins and Adkins (1989) underline the techniques of depicting the existing condition of archaeological remains. However, a valuable source for architectural historians is the hand-sketched reconstructions of monuments that allow better appreciation and understanding. Reconstructions

create buildings and other features of archaeological sites from fragmentary remains. They are not exact reproductions of the buildings, but a picture of what is in the archaeologist imagines.

### 3.2 Image-based reconstruction in 3D

In recent years, several affordable close-range photogrammetric software packages have become available as applications with computer vision algorithms. These offer low-cost and easy-to-use 3D capture solutions for architectural historians. Together with a camera mounted on a drone or directly hand-held, this system can easily capture image data of the ancient remains from various angles. These image-based systems substitute for expensive range-based systems such as laser scanning (Kersten and Lindstaedt 2012). The digital documentation technique used in the Teos archaeological excavation is one of these image-based techniques known as Structure from Motion (SfM). SfM refers to the process of estimating 3D structure from a sequence of 2D images. The algorithm works from the perspective of the human eye and captures the real world 3D structure from 2D images of a moving object or scene. SfM algorithms make it possible to generate 3D digital models from methodically taken 2D photographs (Verhoeven 2011). This method may be briefly summarised as 3D scanning by photography.

From several SfM options, the Teos team chose Agisoft PhotoScan, low-cost commercial 3D reconstruction software with high automation. The software, with no pre-survey calibration or post-survey manual feature selection, estimates the camera locations. Once the photographs are aligned, the software automatically creates a point cloud model. Once the surface is ready, the program generates surface texture from the photograph set and applies it to the mesh model. The resulting highly detailed models are accurate photorealistic 3D representations of the sites and buildings.

### 3.3 CAD-based reconstruction in 3D

Digital reconstruction is a broad term for the computer techniques used in creating 3D models from simple sets of rules to produce scenes in the virtual world. Modelling for heritage purposes requires the construction of accurate geometry respecting and referring to the historical context. The measurement and survey techniques of archaeological excavations need to be respected to create accurate models. This is the traditional approach and the most common method, particularly for architectural elements of simple geometries. These model types are generally created from drawings or measurements and 2D orthogonal projections to build solids. Using CAD software, parts of the models can be arranged in separate layers containing different types of elements.

From several 3D modelling options, we chose SketchUp, a freeware version 3D modelling software with gentle learning curve. The software provides drawing layout functionality, allows surface rendering in variable styles, supports third-party plugin programs from a site called Extension warehouse, and supports placement of its models within Google Earth. Using 3D warehouse, users can create, display and share models. These models are easily uploaded to

# Unfolding Ancient Architecture Through Low Budget Virtual Reality Experience

Google Earth, a geographic information system of a global 3D model platform (Manferdini and Remondino, 2012).

## 3.4 Virtual reality (VR)

On computer screens, the senses are mostly limited to visual and audible experience. Interaction is bound to devices, such as the mouse and keyboard. However, with readily available virtual reality (VR) hardware and software, it is possible to change the quality and quantity of interaction with the virtual environment. Since its inception, the possibilities of VR have explored many fields and have created a particular niche in the development of training environments for such as flight simulation. After an initial period of popularity, the use of VR was limited by expense until smartphone technology and inexpensive head-mounted displays, such as Google Cardboard, produced an explosion in both use and application. This low-cost device provides the end-user with an immersive experience from a smartphone screen, placed close to the eye, by deluding the senses into the belief of 3D space (Varinlioglu 2016). Pre-existing smartphone functions, namely inertial motion sensors, enhance the feeling of reality by allowing subtle movements to control the experience.

In a field where conventional 2D drawings have been the norm, seamless VR technology can have a profound effect on architectural historians. A combination of 2D and 3D with VR technology is proving to be the next frontier for research, teaching, and dissemination. Video game based VR application technologies can be used as both interpretation tools for historians, and as a more immersive interactive fluid environment for the user (Bruno et al. 2010). This study shows that as 3D modelling becomes increasingly automated and accessible, we will soon see a more interactive experience for architectural historians with the addition of easily accessible low-budget VR tools. For its part, Google Cardboard has proven worthy in enhancing the spectrum of understanding for archaeologists, both on-site and beyond.

## 3.5 Unity game engine

The Unity game engine is a convenient tool for developing VR software (Kateros et al 2015), as a beginner-friendly and a powerful game engine. As such, it has a great user community and is very popular among game developers. Its Asset Store contains numerous resources that can be used to develop games quickly. In addition to video games, Unity is a very popular VR development tool, being the only development environment that all three major VR technologies support i.e. Cardboard, Oculus and Vive. Furthermore, the PlayMaker Unity extension enables non-programmers to develop games and VR content visually. For architectural historians to use VR in ways that are not permitted by existing software, the Unity game engine can be used to create custom VR applications that serve their needs. In this paper we introduce an application that enables visual communication and collaboration of 3D scenes in VR.

## 4. Research design

As part of our 3D digital modelling workshop, a group of first year architecture students were briefed on the Teos archaeological survey site and received pertinent archaeological data

including drawings, hand-sketched reconstructions of the buildings, and aerial photographs. To create an understanding of geometry and to equip them with a means of modelling, the students were given an intensive introduction to the 3D modelling software SketchUp. SketchUp was chosen because of its learning curve, covering limited but broad aspects from rendering to animation capabilities. The student groups worked on the theatre, bouleuterion, cistern and the Dionysos temple respectively. After adding the texture, geo-referenced basic terrain models and animations, with eye-level camera angles, were presented to the archaeological team for critics (Figure 1).

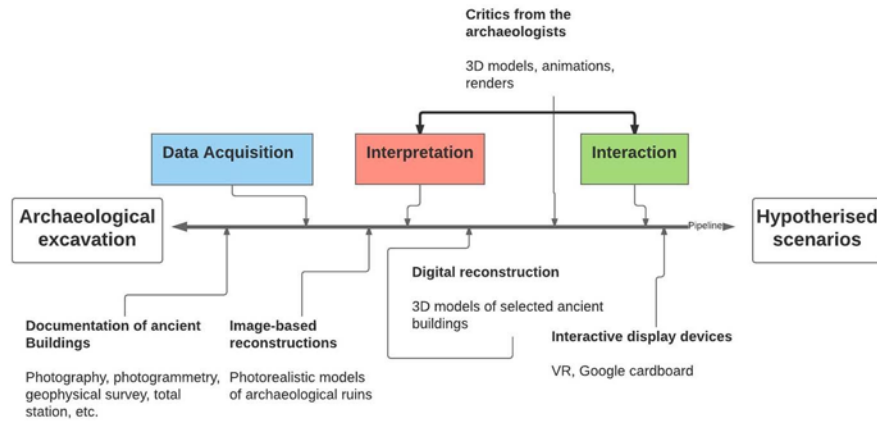

Figure 1: The research pipeline

These initial models allowed us to communicate with architectural historians in the 3D format. Through the 3D reconstruction models of the site and buildings, historians experienced an initial human scale eye-level interaction. Photorealistic models were subsequently imported in the VR scene to compare reconstructions with the actual state of the archaeological remains. This interaction helped modellers to develop and refine the archaeological details of the models.



Figure 2: Aligning the Temple reconstruction drawing with its 3D model

To align the camera using a screen-space constraint, the user first places the in-world alignment widget by interactively setting its transformation matrix  $M_w$ . Then, they place the corresponding screen-space widget, which is a copy of the first widget that is placed in the camera's ever changing coordinate frame as  $M_c M_s$ . The goal is to find the camera transformation



## Unfolding Ancient Architecture Through Low Budget Virtual Reality Experience

$M_c$  that aligns the two widgets. This requires a matrix inversion operation as shown in the second equation below.

$$M_w = M_c M_s$$
$$M_c = M_w M_s^{-1}$$

As a final step, prior to further development, the prepared models were experienced through the Google cardboard apparatus. The effect of this rather simple manual process was appreciated greatly, causing much excitement within the group and bringing new suggestions for the future of VR within the field of the architectural historian. In the application that was developed specifically for this project, users interact with the 3D models by using head motions and the single button on the cardboard VR set. The application allows users to manipulate the 3D models by creating copies, moving them horizontally and vertically or by rotating them as pan and tilt and also by scaling them, using only this single button and head motions. On the VR screen, an in-world widget was used with a screen-space counterpart for easy camera positioning that uses existing illustrations or photographs as a guide (Figure 2).

### 5. Results

The results showed that analysis and research for architectural historians can be streamlined by quickly developing a site-wide VR environment. Individual buildings can be compared with their surrounding terrain and contrasted with similar structures from other sites. Groups of buildings can be checked for alignment and, where less archaeological remains are available, the VR view can hint towards filling-in the gaps.

### 6. Conclusion

In conclusion, although the benefits of 3D modelling are beyond doubt for site-work, research and dissemination, the prior expense of VR and modelling had placed them out of reach for most architectural historians. Through the use of simple equipment and software, what would normally be considered a complex computational project, was in fact achieved without computation. Additionally, with the application of advanced computational parametric modelling tools (procedural modelling), it is further possible that these manually produced models could be automated and parameterized, as with a BIM system, such that the models would be created automatically. Such streamlining, coupled with simple and effective VR systems, can have a positive impact on the work of architectural historians.

### Acknowledgements

We would like to thank Prof. Dr. M. Kadioglu, head of the Teos excavation for sharing his archaeological data. Thanks to our students Y. Yigit, M. Sartik, F. Ugutmen, M. Kumbaraci and

Murat Guler for modelling the buildings, and to A. Isigan for his invaluable critics on the game scenario.

## References

- Adkins, L. and Adkins, R.: 2009, *Archaeological Illustration*; Cambridge University Press.
- Bruno, F., Bruno, S., De Sensi, G., Luchi, M. L., Mancuso, S., and Muzzupappa, M.: 2010, From 3D Reconstruction to Virtual Reality: A Complete Methodology for Digital Archaeological Exhibition, in *Journal of Cultural Heritage*, Volume 11, 42-49.
- Johanson, C.: 2009, Visualizing History: Modeling in the Eternal City, in *Visual Resources*, Volume 25, 403-418.
- Manferdini, A. and Remondino, F.: 2012, A Review of Reality-Based 3D Model Generation, Segmentation and Web-based Visualization Methods, in *International Journal of Heritage in the Digital Era*, Volume 1, 103-123.
- Kadioglu, M.: 2015, "Teos Archaeology Project". Available from: <<http://www.teosarkeoloji.com>> (accessed 8 May 2016).
- Kateros, S. Georgiou, S.; Papaefthymiou, M.; Papagiannakis, G. and Tsioumas, M.: 2015, A Comparison of Gamified, Immersive VR Curation Methods for Enhanced Presence and Human-Computer Interaction in Digital Humanities, in *International Journal of Heritage in the Digital Era*, Volume 4, 221-233.
- Kersten, T.P. and Lindstaedt, M.: 2012. Image-Based Low-Cost Systems for Automatic 3D Recording and Modelling of Archaeological Finds and Objects, in: *Progress in Cultural Heritage Preservation: 4th International Conference, EuroMed 2012*, Springer Berlin, 1–10.
- Varinlioglu, G.: 2016, *Digital in Underwater Cultural Heritage*; Cambridge Scholars Publishing.
- Verhoeven, G.: 2011, Taking Computer Vision Aloft – Archaeological Three-dimensional Reconstructions from Aerial Photographs with Photoscan, in. *Archaeological Prospection*, Volume 18, 67–73.
- Wood, P.: 2002, *Drawing the Line: a Working Epistemology for the Study of Architectural Drawing* (Doctoral dissertation, The University of Auckland).

**Andrew Viny****Daniel Cardoso Llach***Carnegie Mellon  
University**Carnegie Mellon  
University**Pittsburgh, PA, USA**Pittsburgh, PA, USA*[andrewviny@gmail.com](mailto:andrewviny@gmail.com)[dcardoso@cmu.edu](mailto:dcardoso@cmu.edu)

**Abstract:** How might the design fields critically and playfully approach the question of customization? While user-driven customization experiences are becoming increasingly commonplace, barriers to their mainstream adoption remain, as well as critical questions surrounding the aesthetics and politics of their implementation. This paper is premised on the idea that re-imagining design processes as highly inclusive of, and partially directed by, users, has the potential to enable practitioners in architecture and product design to build on and help shape a growing movement toward collaborative creation. It documents a series of concepts and a prototype for a novel design workflow enabled by playful multi-modal “interactors” linked to materially-informed parametric descriptions which can be produced physically through digital fabrication methods. Through playful interactions combining visual and tactile feedback we show how the prototypes stoke the imagination of designers and users, and offer opportunities for design pedagogy, research and practice. Tapping into the spirit of play, the concepts and prototype suggest new avenues for designers and users to collaborate in the creation of architectural spaces and products.

**Keywords:** *Mass-customization, interaction, multi-modal, collaboration.*

## 1. Introduction

This paper reports on the development and evaluation of three concepts of multi-modal interaction for the design of chairs, one of which is prototyped and evaluated. Chair design was chosen as a testing arena because chairs’ functions, determined in part by their interaction with the human body, offer both constraints and opportunities for formal exploration. Further, considering architects’ long-standing fascination with chair design, chairs offer practical advantages as well as important cultural associations for an experimental reflection on re-distributing authorial agency in design.

The paper first situates these efforts within an expanding landscape of user-participation through precedents from architecture, computational, and interaction design. It then presents the concepts and prototype, and documents how users engage the final system to produce different designs. The prototype detects user’s design input through a tangible interface we call “interactor,”

which, through sensors and open source electronics, “drives” a digital parametric model of a chair and produces information for production. We interpret the resulting engagements, which reveal traces of both the hand of the system’s designer, and the user, as illustrations of how agency in design processes might be redistributed along digital and social actors. By leveraging computational tools to bring together a combination of playful physical and virtual interactions, we show a possible route to playful collaborative design processes.

## 2. Background & related work

Mass produced goods have historically relied on standardization to be manufactured economically at scale. This was famously illustrated by Henry Ford when he said of his Model T that, “a customer can have his car painted any color he wants as long as it’s black”. However, advocates of “mass-customization” point at recent advances technology as enablers of a new era of highly personalized manufacturing (Woodward 2005, Gershenfeld 2007). The convergence of this new capacity and feverish appetite presents us with both an opportunity and a cultural-historical problem (Turner 2013).

The fields of architecture and product design have embraced the question of customization, albeit from different perspectives. Architects concerned with customization have explored the systematization and automation of the architect-client engagement as a way to destabilize conventional hierarchies and “democratize” design. Illustrating this view, early work by Nicholas Negroponte (1970) speculated about computational tools capable of replacing the roles of architects and planners in the production of the built environment. Negroponte sought to disrupt what he, along with others at the time, conceived as a rigid and outmoded dynamic between designers and users—for critical and historical perspectives on these projects see (Cardoso Llach 2011 and 2015; Scott 2015; Steenson 2014).

Product designers have also sought to expand users’ influence in design, albeit under the premise of expanding market footprints among increasingly technologically literate consumer bases. This is illustrated by examples such as Motorola’s MotoMaker (2013) and Adida’s FutureCraft project (2015). However, as Tim Crayton notes, “considering it’s huge significance, there has been little consideration of the implications [of mass customization] for design” (Crayton 2001). This lack of concern may in part be elicited by a perceived risk of commoditizing design professions—a contemporary issue in the field of architecture.

Recent projects in the fields of product and interaction design offer insight into this growing landscape of possibilities. “Sketch chair” was developed by Greg Saul (2011) as a CAD like interface, allowed novice users to doodle a chair and apply simulation to test its functionality. Sean Follmer, Daniel Leithinger, Alex Olwal, Nadia Cheng, and Hiroshi Ishii (2014) created MIT’s Jamming User Interface, a tactile display technology, reminiscent of the speculative interface presented by Ivan Sutherland (1965) in *The Ultimate Display*, which enabled users to receive tactile feedback directly from a pneumatically enhanced display. Interactive Fabrication, a series of conceptual prototypes created by Karl D.D. Willis, Cheng Xu, Kuan-Ju Wu, Golan Levin, and Mark D Gross present a series of speculative interfaces which enable a more direct connection

of creators to mechanisms of fabrication. Other projects explore related aspects of tangible interaction design, (Llamas, Kim, Gargus, Rossignac, and Shaw 2003; Sheng, Balakrishnan, and Singh 2006; and Smith, Thomas, and Piekarski 2008). These projects, like the work in this paper, explore new interfaces and interactions to mediate the relationship between designers and users, as well as people and machines.

### 3. Hypothesis

Hybrid interfaces, which employ multimodal interactions combining different sensorial inputs, may promote playful user engagement in collaborative creation processes —especially when these users have mixed backgrounds and skill levels.

### 4. Methods

Three interface concepts were developed, and one was prototyped and evaluated. The concepts and prototypes were produced by the first author in the context of an architecture undergraduate thesis at Carnegie Mellon advised chiefly by the second author. A broader group of advisors, collaborators and enablers is credited in the Acknowledgments section. Along two semesters, the concept evolved from an initial interest in automation in design systems toward human-machine collaboration, informed by a reflective approach to the question of technological agency in design and architecture. Inquiry methods included precedent analysis, analytical writing, diagramming and prototyping through simulations and open-source electronics.

#### 4.1 Concept 1: Projection

The first of these explorations was a concept for a projection-based interface employing computer vision methods to passively detect user measurements and proportions, as well as user specified manipulations (fig. 1). Here users would interact physically with fiducial artifacts controlling a digital “skeleton” of a chair in one planar view at a time. The flat projections would then be meshed to create the final 3D form. This concept was developed through a series of sketches, renderings and use-case scenarios, but was not prototyped. While promising, the system seemed limiting as an interface for design due to the low legibility of the final form —which was visible only through planar sections—, the lack of engagement with the materiality of the final chair, and the relatively reduced “design space” resulting from the limited range of manipulations enabled by the interface itself.



Figure 1. Illustration of projection interaction.

#### 4.2 Concept 2: Proxy

A second interface concept was an articulated, instrumented, armature. This malleable structure would allow users to directly create and observe deformations in a physical artifact (linked through sensors to a digital model) while other manipulations such as color, material or finish could be visualized on the accompanying digital representation. This concept was developed specifically to produce a higher degree of legibility for users of the final form at all times, as well as a more direct physical engagement with the manipulated geometry. Unfortunately this concept resulted in an increased degree of determinism in the resulting outcomes. This was due to the lack of flexibility presented by the fixed armature and the coupling of specific interactions to specific locations on the physical armature. Consequently the high degree of complexity of this concept did not seem well justified by the limited creative potential of the tool. This concept did not evolve past initial small scale prototypes (fig. 2).

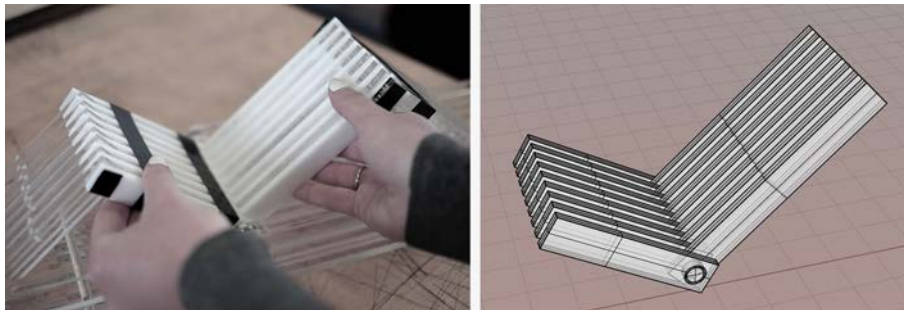

Figure 2. Test rig for proxy tool (left) and accompanying digital visualization (right).

#### 4.3 Concept 3: Interactors

The third and final concept sought to expand the design space for users by creating a new series of interactors capable of driving the geometry of the chairs in various directions and across various axes, and at a number of scales —from chair parts or assemblies of parts, to the entire chair. These interactors, a press and a bend interactor (fig. 3), work by mapping user interactions onto a virtual model in Rhino3D, through Firefly and Grasshopper. They were developed in a series of iterations, which employed a number of pressure and flex sensors, arrayed in grids and embedded within silicone castings, beginning with a single sensor in each and adding additional sensors in subsequent iteration



Figure 3. Version 1 Bend interactor (left), version 1 Press interactor (right).

# [Y]OURS

The interactors were captivating, easily learned, and powerful in their ability to enable users with no 3D modeling knowledge to quickly create basic formal manipulations. That said, because the first iteration of the interactions had only a single, simple sensor to interpret the user's input, they were limited in their ability to understand more nuanced or intricate manipulations. To enable more sophisticated interactions —such as twisting and torquing in the case of the bend interactor and surface deformations with more than a single control point in the case of the press interactor— more complex sensor networks needed to be developed (fig. 4). Redesigning the interactor geometry enabled a greater density of sensors to be employed, which in turn, enabled more complex interactions between the user and tools. These prototypes were then tested and a range of different outcomes were produced by users with limited training (fig. 5).

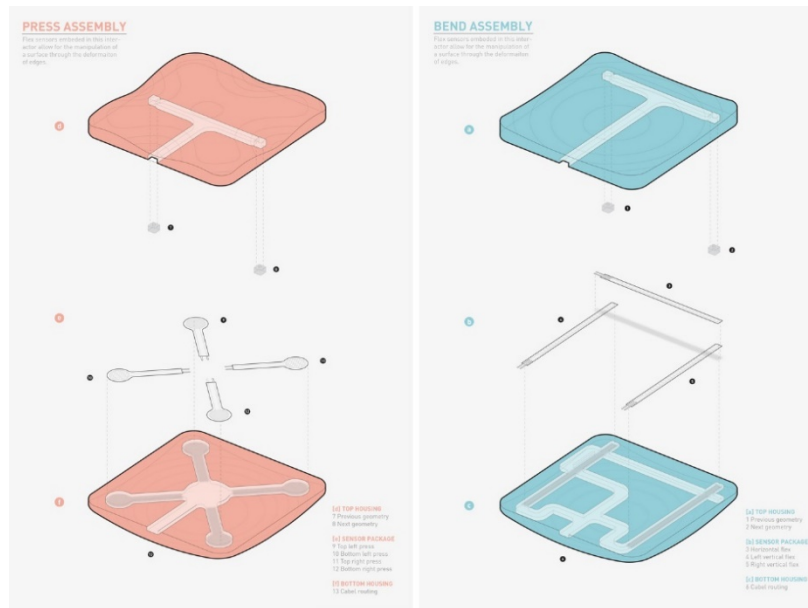

Figure 4. Exploded diagrams of press interactor (left) and bend interaction (right) showing inclusion and placement of sensors.

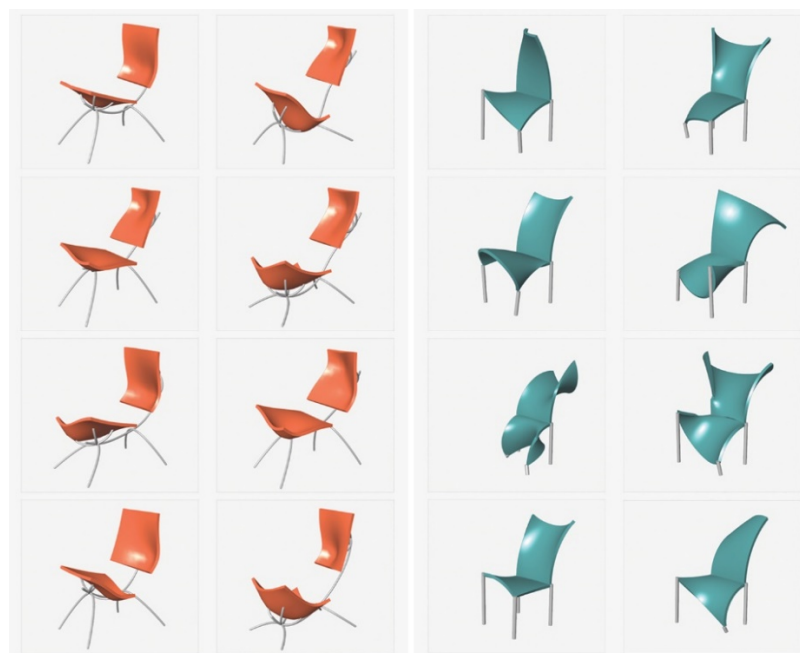

Figure 5. Images of user generated outcomes from both press interactions (right) and bend interactors (left).



## 5. Initial results and next steps

While initial tests showed that these simple sensors were robust and offered a sufficient resolution for geometric manipulation, the software workflow seemed inefficient and increasingly slow as the complexity of manipulations increased. This delay did not become significant enough to create issues for test subjects, but does present a potential barrier for future development. With that said, these tests demonstrated that, users were successfully able to learn the interactions through use, and develop compelling results. The tests were not simply interesting in the outcomes they produced but also in the comments users made while engaging the prototypes. Users said things like: “this is so much fun!”, “I could play with this all day”, “I wonder what else I could make with this.” It is clear then that not only were these prototypes deemed to be usable by our test subjects but that they were also compelling to use, easily learned and un-intimidating to new users (fig. 6).



Figure 6. Interacting with the final press interactor prototype at the CMU School of Architecture thesis exhibition.

Although these results seem successful, future work needs to be done to explore new ways to deploy computationally generated simulation and feedback. These two tools could be extremely important in generating playful design interactions, and opening avenues of future work addressing, for example, the opportunities to design pedagogy when the focus shifts from designing one-off artifacts to designing open, interactive design systems.

## Acknowledgements

Special thanks to Jeremy Ficca, Eddy Man Kim and Eric Brockmeyer who as members of the advisory team helped shape this work through both conceptual and technical contributions. Mary-Lou Arscott, Dana Cupkova and Art Lubetz offered invaluable feedback and support as members of the thesis studio faculty. Scott Hudson contributed guidance early in the project's development. Special thanks to Steve Lee and Kai Gutschow for supporting a thesis studio open to experimentation and speculative work.

## References

- Ariely, D.; Mochon, D.; Norton, M.: 2012, The IKEA effect: When labor leads to love, in the Journal of Consumer Psychology, Volume 22, Issue 3, 453-460.
- Cardoso Llach, Daniel. Builders of the Vision: Software and the Imagination of Design. London, New York: Routledge, 2015.
- Cardoso Llach, Daniel, ed. Exploring Algorithmic Tectonics: A Course on Creative Computing in Architecture and Design. SCDC Press, 2015.
- Cardoso Llach, Daniel. "Inertia of an Automated Utopia: Design Commodities and Authorial Agency 40 Years after the Architecture Machine." Thresholds, no. 39 (July 2011): 39–44.
- Chen, A., Coros, S., Hudson, S., Mankoff, J.: 2015, Encore: 3D Printed Augmentation of Everyday Objects with Printed-Over, Affixed & Interlocked Attachments, in the Proceedings UIST '15, 73-83.
- Cheng, N., Follmer, S., Ishii, H., Leithinger, D., Olwal, A.: 2012, Jamming User Interfaces: Programmable Particle Stiffness and Sensing for Malleable and Shape Changing Devices, In Proceedings UIST '12, 519-528.
- Crayton, Tim. "The Design Implications of Mass Customization." DesignIntelligence. May 1, 2001. Accessed September 07, 2015. <http://www.di.net/articles/the-design-implications-of-mass-customization/>.
- Gershenfeld, Neil. Fab: The Coming Revolution on Your Desktop--from Personal Computers to Personal Fabrication. Basic Books, 2007. <http://www.amazon.com/Fab-Revolution-Desktop-Computers-Fabrication/dp/0465027466>.
- Gross, Mark, D., Levin, Golan, Willis, Karl, D.D., Wu, Kuan-Ju, Xu, Cheng: 2011, Interactive fabrication: new interfaces for digital fabrication, In Proceedings TEI '11, 69-72.
- Llamas, I., Kim, B., Gargus, J., Rossignac, J., and Shaw, C. D. Twister: a space-warp operator for the two-handed editing of 3D shapes. ACM Trans. Graph 22 (3), 2003. 663-668.
- Negroponte, Nicholas: 1970, The Architecture Machine, MIT Press.
- Saul, Greg. "SketchChair." Diatom Studio. Accessed January 07, 2016. <http://diatom.cc/sketchchair>.
- Scott, Felicity D. "DISCOURSE, SEEK, INTERACT: Urban Systems at MIT." In A Second Modernism, 342–93. Cambridge, Mass: SA+P Press and MIT Press, 2013.
- Sheng, J., Balakrishnan, R., and Singh, K. An interface for virtual 3d sculpting via physical proxy. GRAPHITE (2006), 213–220.
- Smith, R.T., Thomas, B.H., and Piekarski, W. Digital foam interaction techniques for 3D modeling. VRST '08, 61-68.
- Sutherland, I.: 1965, The Ultimate Display, in Proceedings of IFIP Congress.
- Stenson, Molly. Architectures of Information: Christopher Alexander, Cedric Price, and Nicholas Negroponte & MIT'S Architecture Machine Group. PhD diss., Princeton, 2014.  
doi:<http://www.girlwonder.com/>.
- Woodward, Richard: 2005. Do Americans Desire Homogeneity? Evidence from Names from 1900-2000, Economics Bulletin, AccessEcon, Volume. 4, Issue 9, 1-6.

## Passive Shading System

### *Towards Parametric Definition and Virtual Simulation*

**Maria João de Oliveira**

*Instituto Universitário de Lisboa  
(ISCTE-IUL), DINÂMIA'CET-IUL  
Lisbon, Portugal  
mjoao.oliveira@iscte.pt*

**Vasco Rato**

*Instituto Universitário de Lisboa  
(ISCTE-IUL), ISTAR-IUL  
Lisbon, Portugal  
vasco.rato@iscte.pt*

**Abstract:** The following article aim to present results of a parametric study of a passive shading control system. The fundamental hypothesis supporting this system find its basis in the natural behaviour of the applied materials - Cork, as well as in its internal and external exchange of data and environmental inputs. Inspired by natural physical elements, the main target is to develop a parametric definition that is formally expressed and designed responding to determined environmental conditions, interacting with the temporary space and surrounding inhabitants.

**Keywords:** *Shading system; Cork; Parametric; Performance; Passive systems.*

## 1. Introduction

Visiting the nineteen century, human constructions were composed by thick walls and small and narrow windows, enabling us to sustain the heat in the interior of the spaces during the winter, and protecting us from the intensive heat during the summer. Narrow windows helped us controlling the ventilation, minimizing/optimizing thermal behavior in the interior of the spaces according with uses and needs. In the twenty century, floor/ceiling walls with narrow steel frames, and the mass production possibilities engage the eternal contract between humans and artificial air ventilation in the interior of the buildings and structures.

At this point architecture and design has been think and developed, by layers of complementary information. Fragmental pieces and different parts that sustain each other by addition such a succession of information data. Form, material and structure are expressed and worked as distinct components of the same body, working independently from each other. However in nature there is no such distinguish. There is no natural body or system, where structure is independent from material, or material working separately from form, or even form composed independent from structure. In nature, elements rise as homogeneous systems, with no distinguish between assemblies or parts. The same element is structure, form and material.

### 1.1 Related work

In the last decades several strategies and techniques were developed, tested and constructed to achieve passive control systems. Starting with mechanical resources, then introducing photovoltaic technology and more recently based on biological organisms.

## Passive Shading System: Towards Parametric Definition and Virtual Simulation

Probably, the first relevant example of shading control systems attached to building façades was the *Los Angeles County Hall of Records* (Figure 1 – Left) from 1962, designed by Richard Neutra and Robert Alexander. Designed to be energy efficient, the south façade of the building it's totally covered with aluminium louvers. Originally made to turn with the angle of the sun throughout the day to allow more indirect light into the building. The system became inoperable few years after its construction. The expensive maintenance and ageing of the components of the system, have knock it off the mechanism and now all the louvers are locked in one fixed position.

In 1987, Jean Nouvel start constructing the *Institute de Monde Arabe* in Paris ((Figure 1 – Right). Referring the south façade of the building, Sharp (1990) describe the composition of the façade as an ocular device composed by numerus and variously dimensioned metallic diaphragms that operate like camera lens controlling the sun penetration into the interior of the building. The mechanical sub-systems, are driven by photovoltaic cells instructors reacting by sun exposure, instructing the independent cells to shut during the sun day and to open after the sunset. This system is still functional, but the costs of its maintenance are still pointed as a trouble issue. Another important reference to this system are the short and narrow openings, only excused for the charismatic character that classifies the iconic building.



Figure 1. Left: Los Angeles County Hall of Records, Los Angeles, 1962; Right: e Institut de Munde Arabe, Paris, 1987.

During the last decade, new strategies for design, new materials and technics have emerged, based on biological models and processes by which natural material forms are produced. The self-organization of biological material systems are dynamic processes that occurs over time and produces the capacity for inducing change in the order and structure of a system, modifying its behavior and performance (Kauffman, 1993). The fundamental idea of the passive systems, are in this context, observed in natural forms and organisms and interpreted as a continuous feedback between structural forces and forms, raising at this point pertinent questions and potentials to rethink architectural systems, processes and bodies.

Bloom (Figure 2 – Left), designed by the Dosu Studio in 2012, it's a passive shading system projected to response to a particular and characterize site, based on the performative behaviour of the materials. Bloom is a bimetal structure installation that reacts to heat, generating increasing or decreasing openings in a pattern, enabling the shading system to adapt to its environment. The system key generator factor, was the profound knowledge of the material, its behaviour

conditions, properties and characteristics, enabling a clearly development of the system behaviour and performance.

Other iconic experience is the 'Hygroskin - The Hygroscopic Envelop Prototype' (Figure 2 – Right) mobile pavilion based Achim Mengues, Oliver Krieg and Steffen Reichert. This building envelope makes use of the hygroscopic qualities of the wood (combined with fibres) to create a self-adjusted structure producing an open and close status, based on the relative humidity, silently and without electricity regulating light and air in its interior. More than finding architectural surfaces as solutions, Menges research group "form follows performance" strategy mixes appearance and organization of patterned skins and structures in nature, enabling to explore materials behaviors and effects - biomimetics and biomimicry (Kolarevic and Klinger, 2008).



Figure 2. Left: Bloom, Los Angeles, 2012; Right: Hygroskin - The Hygroscopic Envelop Prototype, Stadtgarten Stuttgart / FRAC Centre Orléans, 2013.

## 2. Objectives

### 2.1 Scope

This paper presents an ongoing research that aims to develop a passive shading control system, using parametric methodologies based material and environmental knowledge and behaviour. The results are informed by design decisions based on material properties, environmental conditions and physical restriction factors and consequently we are interested in establish a parameter-driven methodology design.

### 2.2 Goal

The main goal defined for this stage of investigation, was to explore through parametric design tools the potential, limits and boundaries of the cork material facing flexion and distortion. The final goal was to determine the bending and distortion material capacities, its limits and physical boundaries to inform the main parametric definition of the shading control system.

## 3. Hypothesis

The fundamental hypothesis supporting this investigation project is based on the cork microstructure geometry and its physical constitution. The idea is, based on the radial section of the cork – its geometric stylization and exploration, generate several geometric patterns, that when printed on the cork boards, will enable the boards to bend and distort in a range of limits

## **Passive Shading System: Towards Parametric Definition and Virtual Simulation**

that will determine and inform the final form and structure of the shading system. The relevance of this step of the investigation will also determine the geometry type of the assembly of the system.

### **4. Methodology**

#### **4.1 Cork Microstructure**

At this stage it's for us fundamental to study and understand the physical (formal and chemical) structure and composition of cork. Material properties are intimately related with material performance. Categorized as an anisotropic material, cork as three different sections, (a) two of them are structurally similar, tangential and transversal sections, are composed by a 'brick' wall composition organized in a 1/3 proportion; (b) and the radial section also called as the honeycomb section, composed by a hexagonal geometry. This physical/geometric organization of the cork microstructure inputs the flexibility and elasticity for what cork is well known. The chemical condition of cork is mainly composed with 15% of cell walls - composed by suberin, lignin and cellulose, and with 85% of pure gas. This chemical constitution of cork is the responsible for its material resistance and resilience, when facing compression and distortion.

Being known for its undoubtable acoustic and thermal competence and efficiency, cork it's currently applied, mostly in hard construction as a thermal insulation or as a vibration floor. But in the last decades, with the improvement of offer of new cork products, the industry are focuses in the development of new types of products and studies of new potential forms and applications.

#### **4.2 Cork driven-parameter**

At this stage of the investigation two types of cork products were considered. EAC - Expanded Agglomerated Cork (also known as Expanded Black Cork) and the CAC - Composite Agglomerated Cork (also nominated as Composite Cork). EAC it's a 100% natural cork product, produced after high temperature compression of the grains, that enables the expansion of them, releasing the lignin and suberin that enable the aggregation of the grains. Its coloration, driven from the high temperatures process, its black. CAC it's mostly composed with resins. The aggregation of the grains its made by artificial products, auditioned to the heat compression process. More heavy and, in general, with higher density compared with the EAC, its coloration conserved the natural coloration of the cork raw material.

The initial tests had considered the original radial section of the cork, correlating its physical geometry with its structural integrity. So the geometric exploration/parametrization were based on the mathematic expression of relation between cells walls thickness, its gas volume proportion and material thickness expression. Manipulating these geometry driven-parameters four different patterns have emerged (Figure 3).



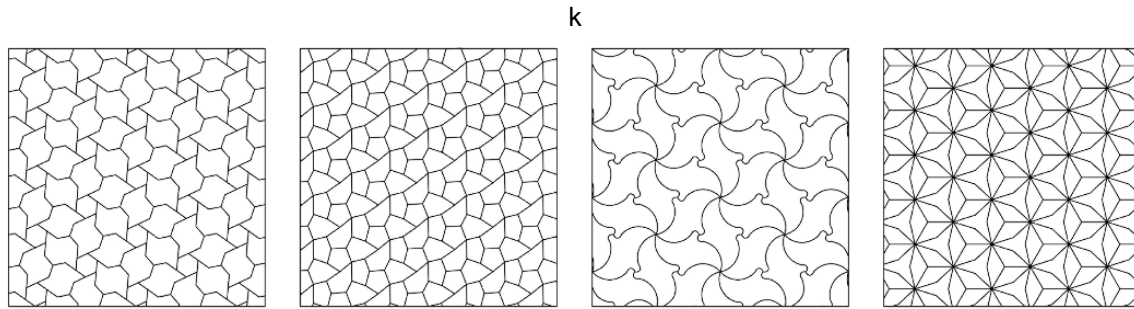

Figure 3. Pattern designation from left to right – Escher; Islamic; Tile and Earth.

#### 4.3 Digital > Physical > Digital

In order to improve the parametric definition and enrich the form/structure relationship, physical tests were prototyped. Through computer numerical control (CNC), several prototypes were produced (Figure 4). The four patterns were printed in the two types of cork (EAC and CAC), with similar dimensions – 500X500X20mm - using the same depth cut (1/2) and with the same diameter tool (3mm).

The idea was to compare the behavioural performance of the material when worked with each of the patterns. The intended parameters to extract were the limits of bending and distortion of each board (each pattern applied to each type of cork and densities). These are valuable parameters to input not only in the assembly composition, but also to inform the global form of the system, working the limits of its components.

Physical tests were conducted. The boards were exposed to distortion and flexion tests enabling us to extract numerical values to input the boundaries parameters – each type of cork has its limits range of values.

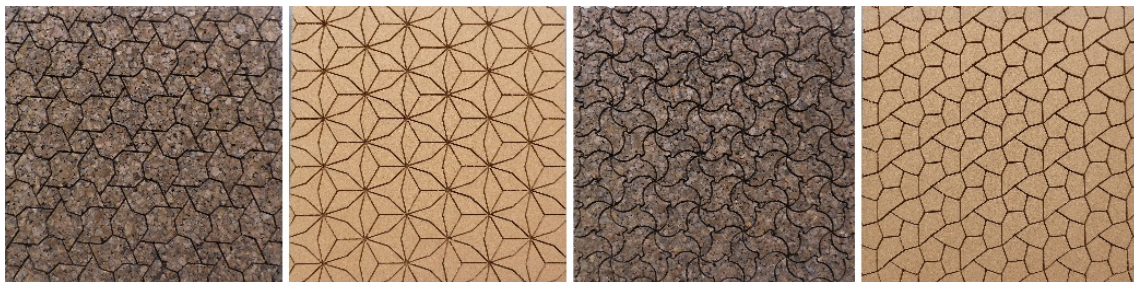

Figure 4. Prototyped patterns, from left to right – Escher; Earth; Tile and Islamic.

#### 4. From material driven-parameters to form driven-performance

The first digital essays of the system, after the material driven-parameters inputs points up two totally different formal approaches.

The first possible conception of the passive shading system form, works with a modular composition of plan boards, exploring the potential of the modular form in its own body and flexion in its modular assembly capacity. This type of system aim to be reconfigurable in its own physical form condition, being also self-supported, and adaptable not only in its digital form but more important in its physical condition. The second possibility it's to explore the flexion and bending capacities of the material, working its self-support condition based limits of tension. However, this



## Passive Shading System: Towards Parametric Definition and Virtual Simulation

solution closes the capacity of physical adaptation and flexibility of the system in the digital process, being the form totally closed after the assembly process. Being totally conceived in digital environment each produced system will be always new, for each environment, for each inhabitant, for each individual context.

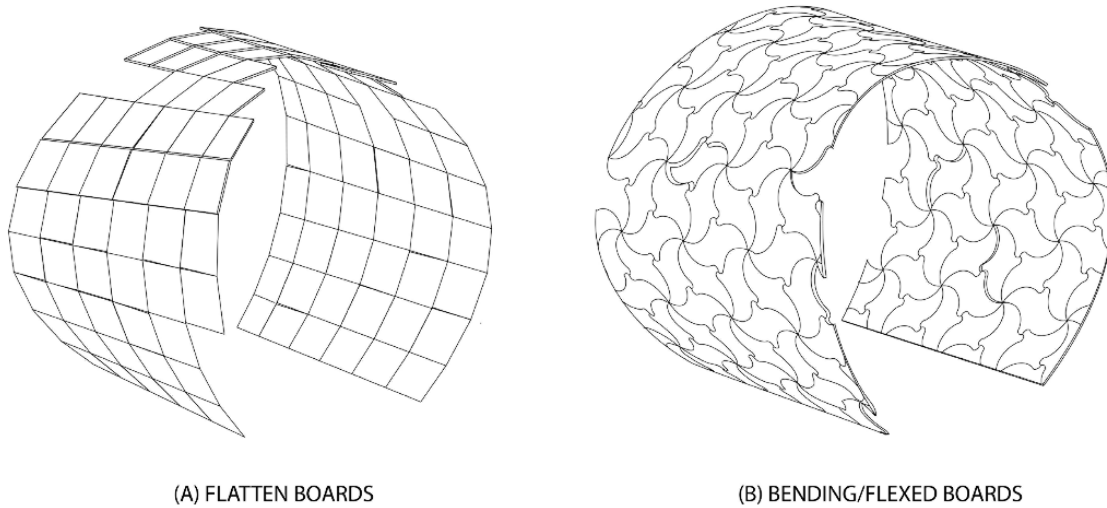

Figure 5. Initial digital prototypes of the shading control system – exploring boards application.

### 5. Insights and future work

Important conclusions have been extracted from the cork samples virtual and physical essays. The durability of the system could be an important factor for its commercialization and potential application. Being made (in its majority) by cork it's an assumed seasonal/temporary system. However the system should contemplate the possibility of being renewable or even prevent the possible substitution of parts during its life cycle time-lapse.

Following steps are related with a more exhaustive form finding structure of the parametric definition. The connection between geometries, design driver, environmental data - through plugins – can still find different methodological choices which are informed by a logic process that prioritize some parameters and solutions according to the initial inputs of the target environment and user.

Towards this objective, the development of this work includes the creation of a pattern for a specific physical location. Environmental conditions such physical surrounding constrains, inhabitants usage and even shading system typology – shell, façade, temporary installation - will always be some of the most determinant driven-parameters of shading control system conception.

### Acknowledgements

The authors would like to thanks to the Amorim Group. A special thanks to Dr. Carlos Manuel, Eng<sup>o</sup> Lopes Infante, and Dr. José Andrade from the Amorim Insulation Industries and to Dr. Marina Rodrigues from the Amorim Cork Composites Industries.

## References

Burry, J., Salim, F., Sharaidin, K., Burry, M., & Nielsen, S. A., 2013. Understanding Heat Transfer Performance for Designing Better Façades. *Acadia*, pp.71–78.

De Oliveira, M. & Rato, V.M., 2014. CORK'EWS From microstructural composition into macrostructural performance. 2nd INTERNATIONAL CONFERENCE OF biobigital architecture & genetics, pp.320–330.

De Oliveira, M.J. & Moreira Rato, V., 2015. From Morphogenetic Data To Performative Behaviour. Emerging Experiences in the PAST, Present and Future of Digital Architecture. CAADRIA 2015, 20th International Conference of the Association for Computer-Aided Architectural Design Research in Asia, pp.765–774.

Hensel, M., Menges, A., & Weinstock, M. 2010. Emergent Technologies and Design. Towards a biological paradigm for architecture. USA and Canada; Routledge.

Kauffman, S., 1993. *The Origins of Order: Self-Organization and Selection in Evolution*. Oxford University Press.

Kolarevic, B., & Klinger, K., 2008. Manufacturing Material effects. Rethinking Design and Making in Architecture. USA and Canada; Routledge.

Oxman, R., 2008. Performance-based Design: Current Practices and Research Issues. *International Journal of Architectural Computing*, 06(01), pp.1–17.

Pearce, P., 1980. *Structure in Nature is a Strategy for Design*. The MIT Press; Reprint edition (June 16, 1980)

Sharp, D., 1990. *Twentieth Century Architecture: a Visual History*. New York: Facts on File, pp. 394. ISBN 0-8160-2438-3. NA680.S517

Silva, S.P., Sabino, M. A., Fernandes, E. M., Correio, V. M., Boesel, L. F. & Reis, R. L., 2005. Cork: properties, capabilities and applications, *International Materials Reviews*, 50 (6) (2005), 345-365.

Schumacher, P., 2009. Parametricism: A new global style for architecture and urban design. *Architectural Design*, 79(4), pp.14–23.

# Games as A Model for Architectural Pedagogy

*Production of architectural genres*

**Damjan Jovanovic**

*Staatliche Hochschule für Bildende  
Künste, Städelschule  
Frankfurt, Germany  
damjan.jovanovic@gmail.com*

**Adil Bokhari**

*Staatliche Hochschule für Bildende  
Künste, Städelschule  
Frankfurt, Germany  
adilbokhari@gmail.com*

**Abstract:** One of the most important disciplinary questions in the field of architecture is the question of contemporary pedagogical models. If the second half of the 20th century was an era of the so-called 'Radical Pedagogies' in architecture, many of which posited participation and interactivity as their models, this question might be formulated as follows: what happens today when the tools for design are finally available to all, and, especially, what happens when it is possible to create complete, fully immersive and inhabitable virtual environments through a medium of computer games? It is, thus, crucial to address questions related to the methodologies of teaching architecture, before discussing design methodologies. In our view, the task of a contemporary educator is to problematize the notion of teaching design in the age of interactive media, and to explore what a new, holistic architectural pedagogical idea can be. The paper aims to record the process of studio development, and deliver a report on the possible new architectural pedagogy arising from the notion of play.

**Keywords:** *Games; Software; Genres; Medium*

## 1. Introduction

As Tutors at the Städelschule Architecture Class (hereafter called "SAC"), responsible for its First Year Program, we have pursued this question through exploring the possibility of devising a new pedagogical model for design, based on the concept of games. The premise is that there is a way of rethinking most architectural design and representation methodologies by understanding them as works of game. Games are here understood as interdependent textual and visual regimes operating through the notion of play, within which a project of architecture is born and claims its stake as reality. The program this year at SAC, titled "Games," is based on these interests. The topic of games is understood and appropriated as a possible basis of a different research methodology, one that goes away from trajectories and pitfalls of positivist science and into a more playful, self-ironic realm where the basic operations of architectural design (drawing and modelling) acknowledge their debt to rule-based play and the construction of fictions. The topic of games, as it pertains to design methodology, also invokes the various 'games' of architecture itself: the figure-ground game, the inside-outside game, etc. Lastly, the emerging medium of computer games is employed as an extra-disciplinary interest, by

investigating this medium's ability to produce total, immersive spatial and temporal experiences, which is something that has historically been the domain of architecture. If it is true that cinema was the defining art of the 20th century, games could well prove to be the same for the 21st.

## 2. Studio Structure

SAC is an international, post-graduate master's programme with students arriving from all parts of the world, with highly varied backgrounds. Thus, firstly, it becomes a challenge to provide a ground where conversations can emerge, not just between the students and teachers, but especially within the context of the work produced. The success of the studio can also be measured by this 'communication,' between the drawings and models being produced by the students. Second, the provided ground should also be fertile enough for each student to find his/her personal obsessions within the discipline of architecture.

This year the First Year Studio has produced 33 highly differentiated projects developed through different formal and programmatic strategies to address the issues presented. Over the course of two semesters, the students went through an in-depth technical training focused on producing highly detailed digital environments. Students have also produced virtual, immersive experiences for their projects, and employ game-like storytelling to present their projects.

## 3. Pedagogical model

### 3.1 Towards a definition of architecture

medium (technical support) + convention (artistic genre, typology, history) + play (!@#?) = Architecture(1)

In this definition, the notion of "play" is presented as a necessary, but undefinable ingredient. The premise of the studio is that *play* is a notion that has to be constructed as a design condition, rather than being an effect of design. In other words, the studio is investigating *play* as part of design methodology, and not the notion of playfulness of design. This is achieved primarily through conceptualising the design tools and insisting on producing custom-made, imprecise and messy software based on computer game logic. In this way, *play* becomes a working method, a direct outcome of utilising a designed, 'nonprofessional' software with embedded game logic.

## 4. Technical Basis

### 4.1 Software as post medium

The Albertian paradigm of architecture as an allographic (2) practice implies that architectural design comprises of forms of notation and representation, and it would seem that mediums is all that architects engage with. Architecture is primarily a cultural, visual practice that operates through design, understood as composition and the arrangement of relations. While architects work with drawings and models, they primarily produce images. With the advent of the digital, according to media scholar Lev Manovich, other media (print, photography, radio, film ...) have been collapsed and integrated into software as a meta-medium. What happens when a medium contains all other media? Everything changes, yet the issue of software's own specificity

## Games as a model for architectural pedagogy

is rarely addressed. Perhaps, it would be pertinent to reintroduce Clement Greenberg's notion of medium specificity (4) in visual culture with regard to the problem of architectural design understood as a software practice. The question becomes: What is it that software can do, that no other medium can? Among other things, software flattens the field of visual effects, and enables messy encounters between painting, cinema, games and architecture.

Firstly, it is important to make a distinction between the conditions for and the effects of media. In the case of cinema, the technical conditions of the medium involve employing a number of discrete units (images) to create an illusion of movement as an effect. The fact that film operates with discrete units does not prevent its effect from being perceived as continuous. The same goes for software. Its dependence on hardware that currently operates in binary states (since we still do not have quantum computers), tells us nothing of the vast field of sensorial effects that it engenders. Similarly, abstract data, infinities and random values may be at the core of computation, but computation only becomes available as a design methodology problem once its conditions and effects become coded in such a way so as to be readable. This is where questions of code and its relation to language in general come to the fore. Yet, coding as a practice and code in general, its apparent similarity to writing notwithstanding, does not immediately lend itself to any kind of aesthetic analysis. Coding depends on the axiomatic, mathematical model and belongs to a different semiology. Only when the outcomes of code become visible as something else than code, does software (and computation) become interesting for design. The crucial question is how these outcomes become visible, and under what circumstances this visibility operates? Algorithms form the core of software's medium specificity, and they produce crucial effects, like interactivity.

The discussion on the nature of algorithms in relation to architecture becomes possible only when algorithms become visible, that is, only when an interface is involved. This is precisely why the computational question in architecture should never be equated with the mere fact of its numerical basis, i.e. the *quantities*, but with how these quantities firstly become manifest optically, and then as visual and semiological *qualities*. Code can be regarded as the basic interface, and yet, architectural design is a visual cultural practice defined by its focus on compositional issues. Design procedures in the digital age are computational inasmuch as they depend on functions of language as code, and code as a representation of space, in the forms of design software. In other words, the conditions of a medium become important only when a question of composition comes to the fore, and only if the conditions themselves can be shown as being composed and composing.

### 4.2 Design Tools

Architects work in software on a daily basis, yet they overlook the specificity of software as a core component of their design process. They simply regard software as a passive medium, not unlike paper. However, if software has its own medium specificity, then its compositional autonomy always already affects and informs the models. In consequence it becomes crucial to pose questions regarding the nature of these virtual (digital or algorithmic) objects and their

relationship with the reality into which they are eventually introduced. This remains, however, a largely unexplored problem in design, as the discipline still very much relies on treating the digital as a mere shadow copy and passive template of the real, or the projected architectural conjecture with no specificity of its own.

The studio specifically avoids the use of tools that have become specialised in their architectural nature, as we believe that such softwares only serve to replicate and reproduce the conventions of architecture. BIM softwares, AutoCad, Revit, etc. all serve as mere simulations of preceding media. Parametric tools like *Grasshopper* are also avoided, on a specific premise that these tools reduce the notion of software to an optimisation tool and computational design becomes in the end equated with simulating the material forces in the traditions of form finding. The ultimate consequence of this approach to design is the flattening of the cultural discipline of architecture into a positivist, goal-oriented quasi-scientific practice.

This is why we rely on using tools that aren't specifically architectural but are being actively used in other visual fields, like animations, computer games etc. Zbrush, Maya and our own custom-designed software called *Platform Sandbox* are used.

#### 4.3 Game-like design environment

This year, a software called *Platform Sandbox* was developed in Unity3d to address disciplinary concerns. Students were trained to not only use the software in a passive manner, but to customise it to address their specific interests.



Yara Feghali, Platform Sandbox Customisation

Traditional design software prescribes a very specific role to the user: that of a disinterested, disembodied subject that has a full access to any projection space, that operates on a spectrum of full visibility and full zoom-in. We believe that this approach continues, re-creates

## Games as a model for architectural pedagogy

and reproduces a specific subjectivity of an architect operating in the “god-mode” of the traditional discipline. A subject becomes objectified, and an architect is an omnipresent and omniscient entity with full control over design space, which supposedly ensures that his authorship is visibly imprinted. We believe that this notion of total empowerment is what leads to very problematic and unexamined political outcomes of design, best witnessed in totalising fictions like Parametricism.

Unlike other software, computer games tend to problematise the notion of subjective agency through either exposing and putting into question the ability of a player, or by disturbing the mere notion of a goal. Play does not have to be goal-oriented, and although most games do have a goal (the ‘win’ state), more and more the inherent specificity of experience leads to the player being content with merely “existing” within a game. Immersion does not depend on, and is more likely even disturbed by, direct calls for action towards reaching a goal. The notions of agency and authorship are thus perceived in a different manner, which enables loosening up the idea of control.

It is precisely the notion of loose control that is being postulated as a new authorial model. Rather than depending on guaranteed outcomes that either come out of total control of the medium, or out of a system based logic of computation, this notion puts the possibility of a new subject first. A subject that is aware of his own entanglement with other, non-human forms of agency, and is willing to explore new configurations coming out of this flat and non-hierarchical relationship.

The Platform Sandbox software utilises the concept of ray casting as a primary method of interaction within design space. Interaction is only possible in the main perspective view, thus preventing any design being done in either plan or section. This reinforces the importance of the volumetric diagram as a primary means of operation. The software does not allow creation of any primitives, it depends on a range of 5-10 architectural elements being designed elsewhere, and then imported into a menu structure. Two forms of configuration are possible: physics-based collisions and intersections / booleans. Each design session is constrained to 20 minutes. The controls are more computer game - like than design software -like, as an almost choreographed use of mouse and keyboard is required.

The “goal” is to create compositions, in one of four ranges of scale. The scale is simply defined by the number of elements in the scene: small for 3-5, medium for 5-20, large for 20-50, and extra large for over 50 elements. The software allows for an easy export of both screenshots in .png, and textured geometry in the .obj format. This configuration enables the creation of a massive amount of models in a relatively short time span, and this speed and quantity enable the emergence of genres within the studio.

### 4. Convention

With the use of unconventional media, it becomes essential to anchor the research within a disciplinary context. The employment of the oldest games in architecture, the figure-ground game, the inside-outside game, the part-whole game, serve this purpose.



This year, the primary focus was on the part-whole relationships in architecture. During the first semester the students worked with a massive, sub-divided whole and in the second semester they work with a composition of parts. The project at the end of the session begins to oscillate between these two strategies producing multiple figurations over multiple scales.



Cecilia Lightbourn, The Smudge

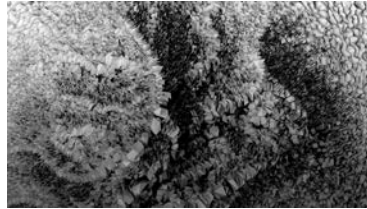

Becca Nayagam, Pixelation

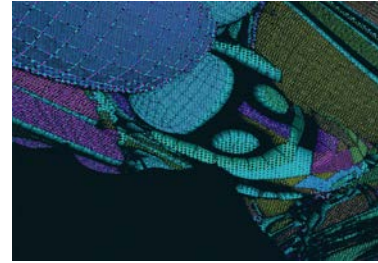

Miriam Kuhlmann, Dissolved

## 5. Style

An overarching interest in the studio has been the investigation of Style; which is defined here as the visual coherence achieved between different scales.

### 5.1 High Resolution

Another implication of the digital tools of design is the seamless shift between scales. Any digital tool today provides a smooth scrolling zoom in/out. However, the problem within the studio is dealt with through the construction of three different scales that do not correspond to each other in a systems based, generated relationship. The endless zoom in of the software is subverted to the production of differentiation between scales and thus not a perfect correspondence but a mis-registration that produces its own spectrum of possibilities. Each student worked on three different scales; namely: mass, texture, and detail. Each project then achieves coherence through these three constructed realities.

## 6. Virtuosity

The focus has been to develop a craftsman-like expertise in the work of each student. As each student develops a completely different aesthetic within the studio, the use of tools and techniques become more and more specific to the projects; proving their legitimacy through their own internal logic.



Becca Navaqam, Pixelation



Cecilia Lightbourn, Smudge



Ivan Tavaréz, Symmetry

## Games as a model for architectural pedagogy

### 7. Project

In order to consolidate the body of work, the students design on a real site with a real project. The design of a university with 33 free standing structures is envisioned, which have their own specific requirements and restrictions. This further pushes the earlier 'form-spiel' (form-play) towards a project which will be more recognisable as architecture.



Lida Badafreh, Project Sketch for an Amusement Park

### 8. Narrative/Fiction

The ultimate goal of the studio is to expose and problematise the notion of an architectural project as a work of fiction, with its own internal rules and narratives. A project is a fiction not because it is unbuilt, or because it lacks a 'truth component': it is a fiction because it has always to be constructed from zero, and because in this construction far too many assumptions are taken for granted and left unexamined, most importantly, assumptions on the subjectivity of an architect, and on the nature of architectural mediums and their effects.



Umut Karakus, Project Sketch for a Watchtower

### References

- (1) Meredith, Michael and Sample, Hillary.;2015, MOS Selected Works, Princeton Architectural Press
- (2) Carpo, Mario.; 2011, The Alphabet and the Algorithm, MIT Press
- (3) Manovich, Lev.; 2013, Software Takes Command, Bloomsbury Academic
- (4) Greenberg, Clement, 1960.; Modernist Painting, in The New Art: A Critical Anthology, ed. Gregory Battcock.

## Hyper-Meritocracy and Architecture

**Arturo Tedeschi**

*A>T, Politecnico di Milano (Italy)*

*info@arturotedeschi.com*

### Introduction

It is estimated that approximately 560.000 individuals in Europe are architects. The 35% of them is under 40 and the 74% of practices are one-person offices which work in measure of 55% in private housing. The average earning is about 30.000€ before-tax, but such a value is much higher for a minority and slimmer for a vast majority of architects. In Italy the 30% of under 40 declares less than 8.000€ per year.

In a world where "winners take all", big companies and archistars represent a small minority of highly competitive players, dominating the architecture market/business where relevant innovations and technologies can be applied. Conversely, the majority of architects work in a traditional, stagnant and loosely regulated market, often forced in offering low-priced services. They also suffering the competition of non-professionals (mostly in the interior design field) and this demonstrates that traditional skills are useless in a framework where any selective advantage doesn't arise from merit.

Such a state of the art is the consequence of several conditions: unequal market, disproportionate architects supply, contraction of economy and, so far, lack of real innovation in the building process.

Moreover, the economic crisis faced by western countries in the last years has brought to a considerable decrease of the spending power of people who consequently decided to reduce the expenses for unnecessary professional. The described landscape has generated a situation in which international firms have the interest and the economic possibility to be up-to-date in terms of information technology and building techniques whereas small firms or individual practices run the risk to be cut out from the market.

If this trend were to continue, we could face an extinction of architecture profession as we know it, though human beings will continue to build houses and buildings.

### The hyper-meritocracy paradigm

In his controversial book "The average is over" Tyler Cowen argues that modern world is on the cusp of a sea change, brought on largely by the rise of artificial intelligence (AI). That machine intelligence will kill most middle-class jobs, as well as the broad prosperity that has characterized advanced economies since the '50s. In this sort of social Darwinism the survivors will be those whose skills complement those of the new technologies. One side effect of the rise of automation is that everything we do can will become measurable. In other words, winners will prevail through a process of "hyper-meritocracy" based on measurable skills. Despite all the

## **Rigid-Foldable Origami Structures: parametric modelling using Grasshopper**

hidden dangers connected to this paradigm, if high-quality education is accessible to people of any social class, hyper-meritocracy works.

*“There is often this naive reaction a lot of people have” says Cowen. “They say, ‘Now I need to take X number of years off, learn all the skills of computer programming and become a programmer.’ Very often that’s a bad way to go. It’s people who integrate technical skills with knowledge of a concrete area and who understand marketing, presentation, and persuasion.”*

Architecture is a field where innovation is very slow and, though architects have always seen change as an opportunity, it is demonstrated a skills gap within architecture around technology and digital aspects of design and construction.

Quoting Cedric Price: "technology is the answer, but what was the question?". What will be the lifeline for architecture allowing a redistribution of work and wealth? Technology is the answer: in terms of new skills and renewed competencies on techniques by which tomorrow’s architecture will be designed and constructed. From parametric design and AAD (algorithms-aided design), to automated manufacturing, to "big data" analytics and virtual/augmented reality, *computation* will be increasingly important as a tool in our environment (built and virtual). Architects should see computation as a technology leading to a crucial shift in industry and society and, more radically, one that can change the way they work.

Far from the current individualistic tendency, a new profession could arise, based on the hyper-meritocracy paradigm extended to the large majority of design-professionals. Besides, roles that deal with relationships, negotiations, and active listening and these traits are among the most desirable skills for future professionals including: complex problem solving, critical thinking, creativity, people management, and coordinating with others.

### **A new profession arises**

*Algorithmic design is not simply the use of computer to design architecture and objects. Algorithms allow designers to overcome the limitations of traditional CAD software and 3D modelers, reaching a level of complexity and control which is beyond the human manual ability.*

Arturo Tedeschi  
(AAD Algorithms Aided Design - LePenseur  
2014)

To face the unprecedented complexity of real world, designers must get a deep control and understanding of datasets and, mostly, they have to find new strategies to collect data and process them in order to inform the design. From running-shoes to high-rise buildings or bridges, data are crucial to develop ambitious projects, which necessarily emerge as articulated entities, not as a representation of complexity but as the solution for complexity.

The current - and still evolving- stage of digitalization applied to architecture is demonstrating us that digital tools are useful to explore a potentially unlimited number of design solutions in order to find the best solution to a specific problem. The design project does not find his essence in a priori defined specific wills but it is the outcome of a process in which an important role is played by new forces that was impossible to describe and control so far. As Davide Lombardi says "the inspiration and guidelines of the design intent are no more collected from the rules of an architectonic tendency or from artistic influences but they found their reasons in sets of data gathered from the environment". We not only refer to 1 to 1 scale built environment but primarily to the realm in which physical forces, structural strain and stresses or the molecular properties of materials exist and carry out their functions. Further, the environment is also the space in which huge masses of agents are spread out according with flock-based behaviour and responding to external stimulations defining new paths through cities and places. This enlarged environment has a strong multi-scalar future, from the microscopic to the urban scale.

It is possible to recognize the birth of new kind of professional - the computational designer - that deals with a wide range of computational tools that allow him to control and investigate the defined new environment. Data represent the real innovation introduced by the digital turn and embody the passing of representation as the main tool to design and show the project idea. Due to their neutrality and to the inner mathematical nature, the use of data within the computational setting has to be driven by mathematical rules. The data represent the input and the output of the design process, the start and the end point of an ideal path made by consecutive logic steps or instructions. This is the area in which the Algorithm-Aided Design is born. It explores new fields gaining its power from the ability to describe the complexity of the real world through numbers and mathematical functions. The AAD is founded on the analysis of the factors that affect the project and, when translated into data, it analyses and uses them in order to inform the process and to optimize the outcome according to a determined fitness function.

This tendency is also underlined by the always stricter relationship between architecture practices and academia. If one of the new fundamental prerequisites to survive on the market is to be highly skilled in a wide range of fields like logic thinking, data management and interpretation or coding (as well as the classical knowledges about how to imagine a concept or a space) it goes without saying that new practices have to activate interdisciplinary researches through the collaboration with universities or hiring people with cutting-edge backgrounds.

Therefore, in a kind of loop effect, this request of "architects 3.0" is also affecting the way in which architecture is taught and academic programmes are established and delivered. Following the example of well-known academic institutions spread across the Europe that have been ground-breaking in teaching architecture with a strong focus on digital tools and approaches, today all the school of architecture are pushing their students to be more and more engaged with digital devices that can help to carry out new projects and visions.

## **Rigid-Foldable Origami Structures: parametric modelling using Grasshopper**

In this context also the profession of educator is going to change. New problems require new and different solutions that have to be investigated via innovative ways developed across the 4-5 years of an educational path. Teachers have to guide students to expand their ability to read and understand the world as a space full of information that have to be collected and ordered logically in order to generate, concurrently with sets of rules, a process. The main goal is to move away from the aesthetic-orientated approach to join a data-driven process that can lead the new architect to control all the phases of a design project, from the early design stage to the building site.

To sum up, the role of the architect is no more the one of the person with a strong creative attitude who draws the idea blowing up in his mind, but he is an expert in the use of logic strategies to explore all the aspects he wants to embed in his design strategy.

# Rigid-Foldable Origami Structures: Parametric Modelling with Grasshopper

*Geometric and structural issues*

**Giulia Curletto**

*University of Genoa*

*Genoa, Italy*

*Giulia.curletto@edu.unige.it*

**Abstract:** Rigid-foldable systems inspired by Origami enable the development of complex structures only governed by few variables. A method to design deployable structures considering geometrical and structural issues is described. Drawing of the geometry and analysis of the structural behaviour are integrated in a continuous process to find the best configuration of deployment. Parametric design is proposed as the ideal powerful method for modelling Origami structures, applicable in both geometrical and analysis processes. The parametric software Grasshopper has been applied to draw the geometry and to control the leading configuration parameters, while FEA software has been used to study the structural behaviour. To connect parametric and structural analysis software, GeometryGym (Grasshopper plug-in) has been investigated as particularly interesting to define the structural features. The purpose of this paper is to provide a guideline to design Origami structures using parametric methodology and to describe drawing and structural analysis steps applied to two specific cases: Waterbomb and Yoshimura Origami.

**Keywords:** *Origami Modelling; Rigid-Foldable Systems; Parametric Design; Structural Analysis in Grasshopper; Yoshimura and Waterbomb Origami.*

## 1. Introduction

Many deployable structures, derived by Origami folding principle, are ever more experimented suggesting emergency shelters, building elements and solar sails. Folding is a simple and inexpensive process for transforming matter to fast and easy obtain three-dimensional shapes, and kinetic properties of folds make them extremely versatile suggesting a wide field of application. Despite these properties, the use of deployable structures is limited to prototypes and few products because of modelling and manufacturing issues. The complexity of the geometry and its mechanisms, discussed by some researchers (Tachi et al. 2011, Tachi 2013), has to be integrated with kinematics and structural analysis during the deployment, as presented by Schenk and Guest (2011). Again, problems related to connection by hinges, material, thickness, and forces required to deploy the system have to be considered. In this paper, two-dimensional foldable systems inspired by Origami are investigated, carrying out modelling principles.



# Rigid-Foldable Origami Structures: parametric modelling using Grasshopper

## 2. Origami modelling: parametric process

A correct and detailed modelling is necessary to understand the behaviour of Origami models, and to simulate the folding process and the structural response. Many approaches for modelling and simulating folding motion of Origami have been proposed, starting from Miyazaki et al. (1996), to recent examples, as proposed by Tachi (2009). However, some tools are not suitable for complex Origami, limiting the simulation to models whose folding process is divided into simpler steps. Others are limited to the drawing and simulation of Origami, without considering technological and mechanical issues. Parametric methodology seems to be the ideal instrument, in which both geometric and technological features are integrated. Parametric process using the software Grasshopper is here investigated, where sequences of algorithms and graphic results are shown for each step in order to provide a method applicable to different Origami.

## 3. Origami geometry: drawing with Grasshopper

In this section, a method to draw Origami using parametric tools is described. First, we identify the Origami pattern and the base module to reproduce, described by the periodicity vectors. The base module is the start point to develop each algorithm, because it governs the length and the width of the pattern. Then, we distinguish independent and dependent geometric parameters that describe the Origami. One important parameter to consider is the angle of deployment  $\varphi$  that manages the deployment of the system. Here, the process is applied to two specific cases: Yoshimura and Waterbomb Origami (Figure 1). Both of them are two degree of freedom Origami, presenting a deployment in space, which increases the modelling complexity.

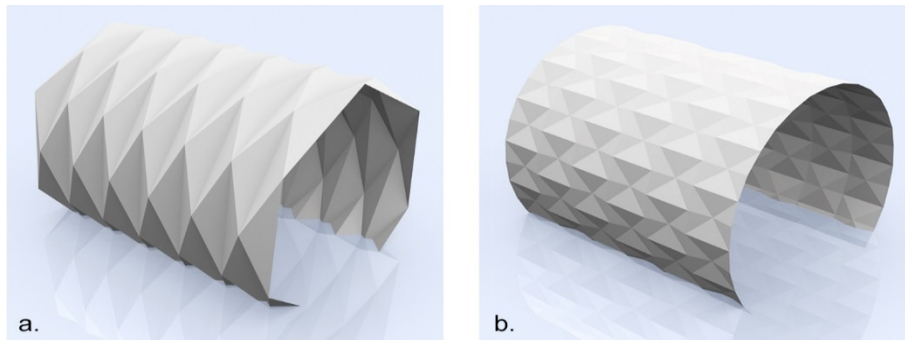

Figure.1: (a) Yoshimura Origami, (b) Waterbomb Origami.

### 3.1 Base Module: identification of Parameters and Drawing

The first step regards the identification of the parameters that describe a specific geometry. The dimensions of the base module – the length and the width – are independent parameters chosen by the designer. While the angle and the direction of rotation between adjacent faces has to be evaluated for each Origami. During the deployment, the faces exhibit rigid movements, resulting in free relative rotations between adjacent faces connected by edges. The angle of rotation  $\delta$  between adjacent faces is obtained considering the rotation of the segments around the relative axis of an angle of deployment  $\varphi$ ,  $\varphi \in [0, \pi/2]$ . Once are defined the dimensions and

the angle of rotation  $\delta$ , the base module and its deployment can be developed using parametric software Grasshopper. In the reference system  $(O, x, y, z)$ , we define the points that describe the base module – the intersection points of the folds – and its central point on a plane  $x, y$ . The points with  $x = 0$  rotate along  $x$ -axis of the angle of deployment  $\varphi$ , while the points with  $x \neq 0$  rotate along  $y$ -axis of an angle  $\delta = f(\varphi)$ . The direction of rotation depends by the position of mountain and valley folds so it varies for each specific Origami. Then, the rotating points are linked to the central one creating the segments that represent the edges of the base module surfaces. Connecting the surfaces the base module and its deployment is obtained (Figure 2).

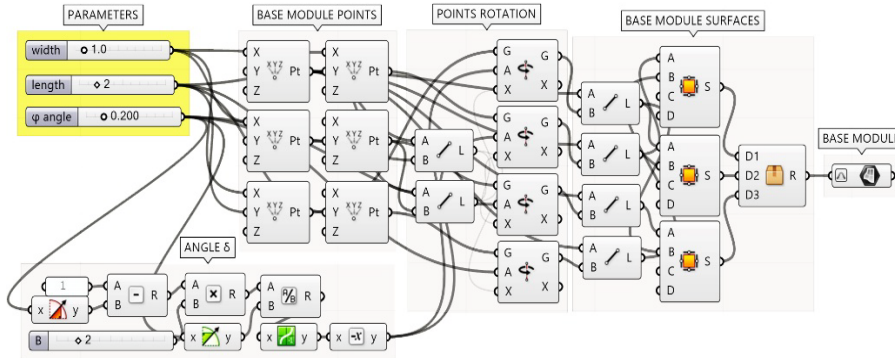

Figure 2: Yoshimura Origami algorithm developed on Grasshopper with indicated the main steps. In yellow independent parameters.

Now let us consider the geometry of two specific Origami, Yoshimura and Waterbomb, to exemplify the process previously described. These models present a similar pattern, but remarkable differences are evident in the deployment process. Yoshimura base module Origami (Figure 3a) consists of a rectangle  $l \cdot w$  – geometric independent variables – divided into six triangles by a segment that vertically splits the rectangle into two equal parts and the diagonals of the rectangle. The edges of the triangles coincide with the folding lines of the module and indicate the direction of rotation (mountain folds in blue and valley folds in red). The relative rotation of these folds, measured by the angle of rotation  $\delta$  and the angle of deployment  $\varphi$ , enable the deployment of the geometry. Considering  $\varphi$  as independent parameter ( $\varphi \in [0, \pi/2]$ ),  $\delta$  is expressed by the relation:  $\delta = \arcsin(2 \cdot (1 - \cos\varphi) / \sin\varphi)$ . While the most part of Origami present at least two geometric variables, Waterbomb base module Origami (Figure 3b) consists of a square  $l \cdot l$  – unique geometric independent variable – divided into six triangles by two diagonals (valley folds), and a vertical segment located at half-length (mountain fold). In this case, the relative rotation angle  $\delta$  is obtained by the following relation:  $\delta = \arcsin((1 - \cos\varphi) / \sin\varphi)$ ,  $\varphi \in [0, \pi/2]$ . The algorithmic process to draw the geometry follows the steps previously described, but in Waterbomb case the direction of points rotation is opposite of Yoshimura Origami.

## Rigid-Foldable Origami Structures: parametric modelling using Grasshopper

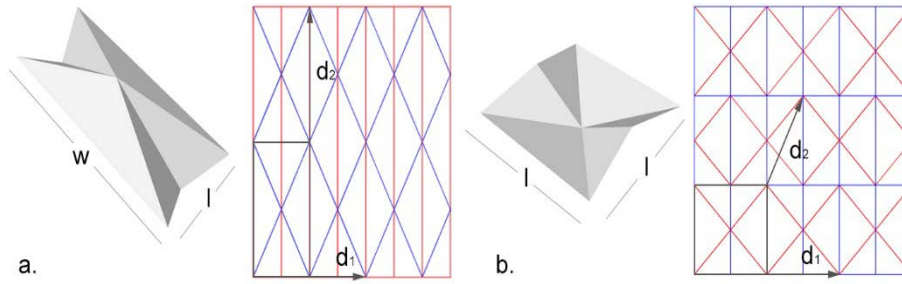

Figure 3: (a) Yoshimura Origami (b) Waterbomb Origami base module and pattern.

### 3.2 Origami pattern: compatible replication of the modules

On Origami modelling, problems concerning deployment mechanics and compatibility conditions to obtain a pattern have to be evaluated. In this section, we focus the attention on the periodicity vectors to replicate the base module and obtain an Origami pattern, considering compatibility conditions of adjacent modules during the deployment mechanism. The periodicity vectors are defined for specific Origami because they vary with the relative position of adjacent modules and the number of principal directions. For example, Yoshimura is characterized by a periodicity vector  $\mathbf{d}_1 = l \cdot \mathbf{e}_1$  along direction  $\mathbf{e}_1$ , and a periodicity vector  $\mathbf{d}_2 = w \cdot \mathbf{e}_2$  along direction  $\mathbf{e}_2$  (Figure 3a). Waterbomb is characterized by a periodicity vector  $\mathbf{d}_1 = l \cdot \mathbf{e}_1$  along direction  $\mathbf{e}_1$ , and a periodicity vector  $\mathbf{d}_2 = \frac{l}{2} \mathbf{e}_1 + l \mathbf{e}_2$  along direction  $\mathbf{e}_2$  (Figure 3b). Now it is assumed to have a second module with the same characteristics of the base module and with a side in common. If Origami have a deployment in plane, for example Miura Origami (Schenk M., Guest S. D., 2013), the modules can be copy and translated of the value given by the periodicity vectors. If Origami have a deployment in space, it is important to ensure the compatibility between adjacent modules, so the relative rotation angle has to be estimated. Let us suppose the second case, both Yoshimura and Waterbomb have a deployment in space. We consider a base module  $a$  and a second module  $b$  having a side in common with the first one, whose position is identified by the periodicity vectors. To evaluate the angle of compatibility between the two modules, we project a point  $A$  on a straight line  $s$  passing through the side in common, then we develop a circle  $C$  with center  $A'$  and radius  $\overline{AA'}$ , and we calculate the intersection between the circle  $C$  and a plane  $yz$ , so obtaining the point  $B$ . The angle  $\widehat{AA'B}$  satisfy the compatibility condition and it lead to coincide  $A$  with  $B$  (Figure 4a). This geometric construction is developable using Grasshopper (Figure 4b) and it can be applied for Origami with a deployment in space.

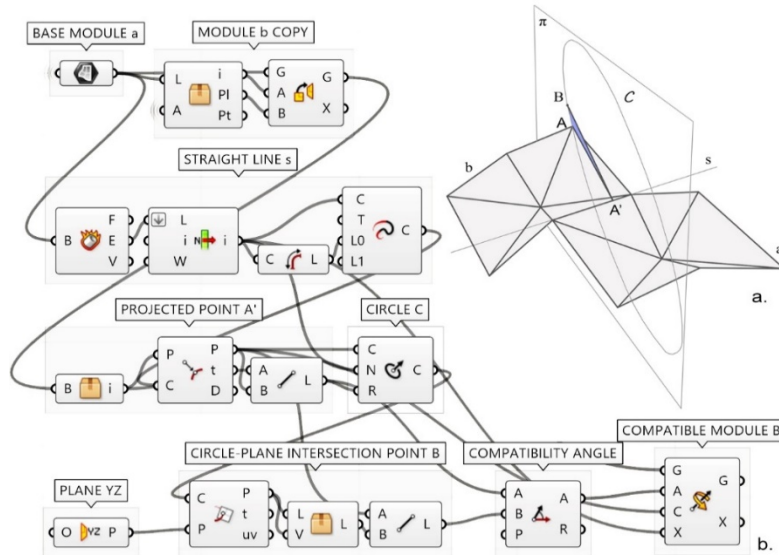

Figure 4: (a) Geometric construction to replicate modules, (b) Waterbomb Origami algorithm developed on Grasshopper with indicated the main steps.

#### 4. Origami structural behaviour: data assignment and analysis

One of the purpose of this paper is to illustrate how to draw and analyse Origami in the same workflow. The first step of modelling was focused on the geometric drawing of Origami, now we are going to discuss the algorithmic sequence processed to define the structural features of a complex model, and to obtain its structural behaviour. The study of the behaviour for different statement of deployment is useful to identify the best operating configuration. In fact, varying the geometric parameters and their relation, different configurations can simultaneously be obtained extracting geometric, technological and structural data, integrated in the same process.

##### 4.1 Focus on Origami Mesh: modelling conditions

The structural analysis using parametric methodology requires to convert a geometry in finite elements paying attention to some conditions that guarantee a correct process. The surfaces modelled on Grasshopper have to be converted to finite elements composed by triangular or quadrilateral mesh. Mesh surfaces, also called polygonal mesh, are defined as a set of adjacent polygons that determine the overall shape. In this section, we briefly investigate the conditions to develop a proper mesh system (to a detailed explanation about mesh see A. Tedeschi, 2014). A correct design method satisfies the following conditions (Figure 5):

1. Compatibility: coincidence between nodes of adjacent surfaces;
2. Orientation: same direction of surface vectors;
3. Discretization: the denser is the mesh the more detailed is the analysis.

In Origami modelling, the discretization in finite elements can be complicated to carry out because of problems related to compatibility and orientation, so the use of additional Grasshopper plug-ins, like Weaverbird – developed by Piacentino G. – is recommended. It includes some specific components to subdivide and join mesh, and to unify surface vectors. The system so acquired, composed by vertices, edges, faces, is the base point to process the analysis of the structural behaviour, in which vertices are converted to joints, edges to frames and faces to shells.

## Rigid-Foldable Origami Structures: parametric modelling using Grasshopper

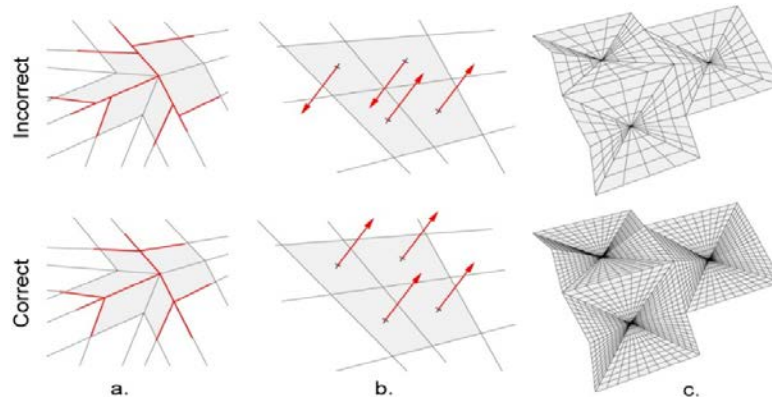

Figure 5: Incorrect (first row) and correct (second row) construction of mesh based on the conditions: (a) compatibility, (b) orientation, (c) discretization.

### 4.2 Structural behaviour: data assignment, analysis and results

Structural features enable the definition of Origami structures, including information about material, thickness, load conditions and restraints. In this step, structural parameters are integrated with geometric ones to describe an Origami model. Various Grasshopper plug-ins develop structural analysis all converting a geometry to a finite element system that enables an accurate representation of complex Origami and the relative results. Most part of plug-ins work inside Grasshopper, while Geometry-GymSap (developed by Mirtschin J.) allows to add structural features on Grasshopper, then the model is exported to FEA software Sap2000. It enables a more detailed analysis, in which stresses and membrane forces can be investigated carrying out the Origami behaviour.

Let us consider an Origami mesh geometry composed by  $n \cdot n$  modules in a specific configuration of deployment  $\varphi \in [0, \pi/2]$  (Figure 7a). The steps to obtain a structural model using Geometry-GymSap plug-in are described (Figure 6). First, mesh are converted to finite elements, whose material and thickness conditions are imposed as shell properties assigned to finite elements (a full database about material properties is included). Then, supports are defined identifying the vertices of the mesh to constrain and imposing restraint conditions. Finally, it is possible to assign different load conditions: for example temperature or pressure loads, mesh or point loads, static or modal cases, which can be combined.

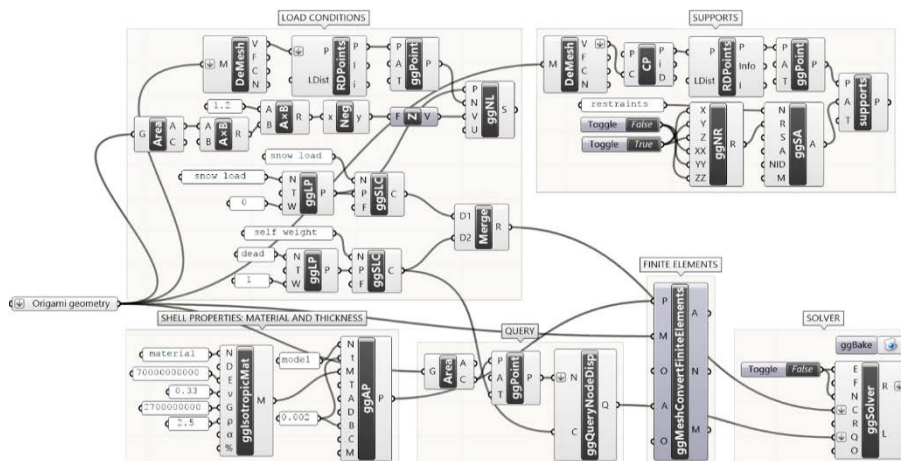



Figure 6: Algorithm to define structural features developed in Geometry-GymSap.

When the features are defined the model is assembled and exported automatically to Sap2000, where the analysis is made and the data are shown (Figure7b). Results can also be visualized on Grasshopper as values to combine with parameters to optimize the model and to find the best operating configuration.

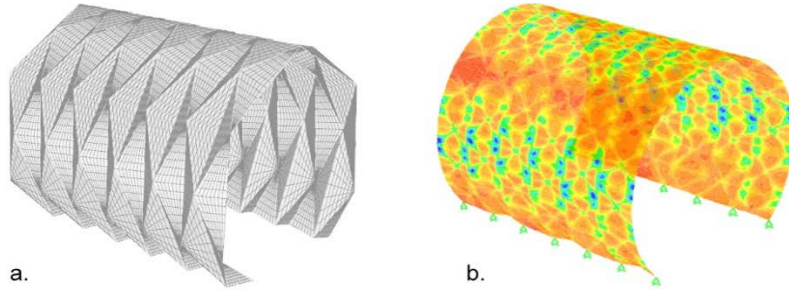

Figure 7: (a) Yoshimura Origami mesh surface, (b) Waterbomb Origami example of structural result: equivalent Von Mises Stress.

## 5. Conclusions

A method to design complex Origami was proposed, describing the geometric parameters that enable the definition of shapes, and showing the mechanism to correctly obtain the deployment and the structural behaviour of Origami models. As a result we get an interactive system that user can replicate to model different Origami and deployable-systems in general. Mechanical analysis results in detail and technological issues related to material and connection by edges are not described in this paper and remain to be discussed in future works.

## References

- Mirtschin J., GeometryGym, OpenBIM tools for architects, engineers and the construction industry, <https://geometrygym.wordpress.com/>, (accessed 27 April 2016).
- Piacentino G., Weaverbird: topologic mesh editor, <http://www.giuliopiacentino.com/weaverbird/>, (accessed 27 April 2016).
- Schenk M., Guest S. D., Origami folding: a structural engineering approach. Origami 5: 5th International Meeting of Origami Science, Mathematics and Education 5OSME, 291-303, 2011.
- Schenk M., Guest S. D., Geometry of Miura-folded meta-materials, PNAS, 110, 3276-3281, 2013.
- Tachi T., Rigid Origami Simulator, [www.tsg.ne.jp/TT/software/](http://www.tsg.ne.jp/TT/software/)
- Tachi T., Simulation of Rigid Origami, in Origami4, pp. 175-187, 2009.
- Tachi T., Masubuchi M., Iwamoto M., Rigid Origami Structures with Vacuumatics: Geometric Considerations, IASS-APCS 2012, Seoul, Korea, 2011.
- Tachi T., Freeform Origami Tessellations by generalizing Resch's patterns, Proceedings of ASME 2013 IDETC/CIE (Symposium on Origami-Based Engineering Design), DET2013-12326, Portland, USA, Aug. 4-7, 2013.
- Tedeschi A., AAD Algorithms-Aided Design. Parametric strategies using Grasshopper, Le Penseur, 2014.

## Reconfigurable Structural Assemblies Using Augmented Reality

**Parantap Bhatt**

*AA EmTech*

*London, UK*

**Nicolo Bencini**

*AA EmTech*

*London, UK*

**Spyros Efthymiou**

*AA EmTech*

*London, UK*

**Antoniya Stoitsova**

*AA EmTech*

*London, UK*

**Abstract:** The research focuses on folded sheet configurations and their development to create an assembly system to form a reconfigurable structure. Through a series of digital and physical experiments a component system was developed to adapt at different contextual and programmatic scenarios. Structural & environmental analyses at various scales were carried out to understand the properties of the system in different configurations and develop protocols for its use. Through experiments it was also understood that the data for system assembly and disassembly was as important as the component design itself. Hence specific attention was given to link assembly data and folded sheet components. As part of these explorations, object tracking and augmented reality applications were explored as tools for overlaying real-time construction information for system assembly and reconfiguration. Experiments across multiple scales were conducted to study the various methods of translating digital geometrical information into a series of guided physical manipulations. The research was conducted in two phases and concluded with an outline of the proposed assembly, disassembly and reconfiguration strategy for the structure as well as an overview for detailing the component. The viability of using the proposed guided assembly methods were also assessed and suggestions for its implementation into realistic construction scenarios were outlined.

**Keywords:** *Algorithms, Architecture, Computational Design, Digital Design Strategies, Digital Fabrication, Geometry, Human-computer Interaction, Interactive Architecture, Programming, Virtual/augmented Reality*





Figure 1. Sword of Damocles-Augmented reality headset developed in 1968

## 1. Introduction

Design and Architecture has always been influenced by philosophical and physical territories of many other disciplines. It is constantly evolving and extending its limits depending upon the social, cultural, art, science and technological advancements. In the current age of information, communication and technology; human life is being radically altered by the rate of change. Because of the current global scenarios definitions of spaces are boundless, free and without rules. This unpredictability of situation leads to the need for a high state of flexibility to exist in all things around. In the words of Richard Buckminster Fuller: Cities have turned into a continual evolutionary process of evacuations, demolitions, removals, temporary vacant lots and installations.

One of the most challenging aspects of architecture and the construction industry during these times is building redundancy, which leads to the demolition and unnecessary disposal of structures and their parts. Most buildings are demolished with no or little attempts for recovery of their constituent parts causing a large scale problem of material waste and exploitation of resources. [1] If the building sector is to respond to such global environmental and economic challenges, it needs to adopt to new construction methods. Rather than destroying structures and built systems, structures need to be disassembled with the potential for their components to be reassembled in new configurations. Off-site manufacturing and fabrication techniques have improved the efficiency of construction processes by allowing for the creation of unique building components to tight tolerances. However limitations in terms of their adaptability have restricted their on-site use. Furthermore in a fully automated assembly process most of the tools are suited to only one particular task and are not able to adapt to different scenarios [2]. On-site operations that cannot be fully or partially automated (and often involve human labourers) can be supplemented through the use of technologies which allow for the integration of the digital data from automated processes with the flexibility of manual assemblies. This guided assembly process is not a different form of building construction, but the addition of a new layer of construction data onto current methods [3]. Guided assembly under this context is described as

## Reconfigurable Structural Assemblies Using Augmented Reality

a “Process of planning and producing a designed part via an aid of information” [4]. In the past, physical guides such as paper manuals, diagrams for sequences or conductors who would orchestrate the sequence were the major controllers of guided assembly. However, since the development of modern technologies capable of storing and relaying large amounts of data, these analog guides have been replaced with digital information. With the rise of personal mobile devices capable of carrying large amounts of construction data, the link between building component and assembly data is being bridged [5].

Within this context, object tracking and augmented reality are explored as another set of technological implementations which enhance the construction process by supplementing operations that cannot be fully or partially automated. “The term Augmented Reality (AR) is used to describe a combination of technologies that enable real-time mixing of computer-generated content with live video display.” [6] These systems involve relaying real-time construction information or assembly logics to the user with the scope of improving the accuracy and reducing the duration of construction.

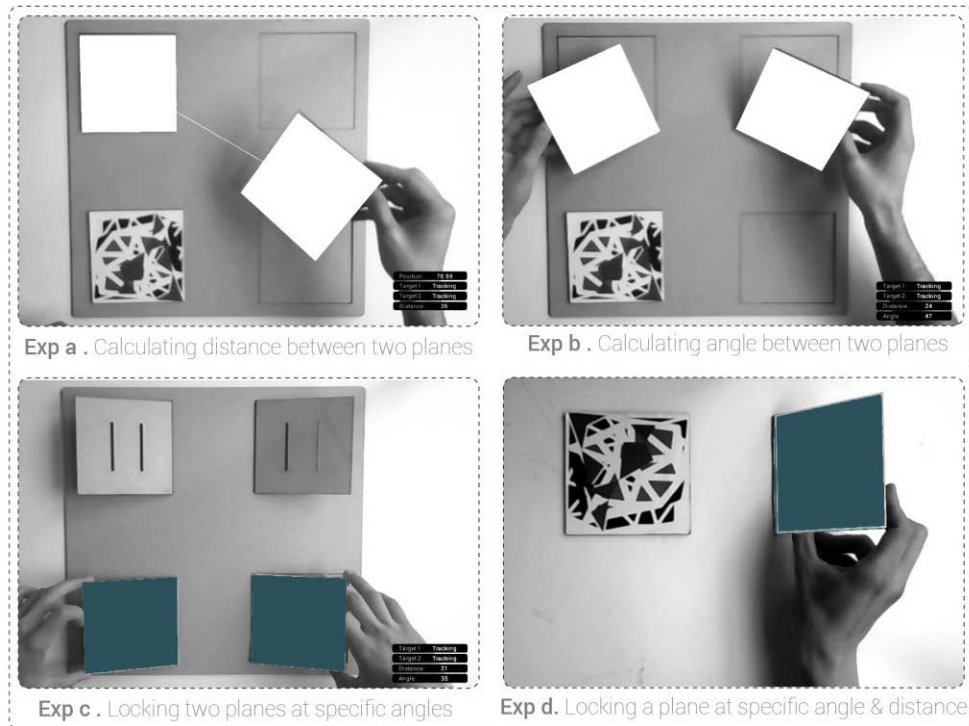

Figure 2. Tests conducted with overlaid digital information on physical objects

## 2. Geometric Explorations: Folded Sheet Assembly

The system development was carried out in phases where the first phase was focused on identifying the geometrical requirements for a reconfigurable system; through a series of physical and digital test. Semi-regular tessellations developed by Ron Resch were chosen as the base geometry to develop a folded sheet system. A flexible system of regular components which could be aggregated in different ways were used to experiment with varied global surface curvature. The types of locks needed to form these surfaces were also identified where synclastic and single

curvature surfaces required only compression locks but to form anticlastic surfaces both compression as well as tension locks were necessary.

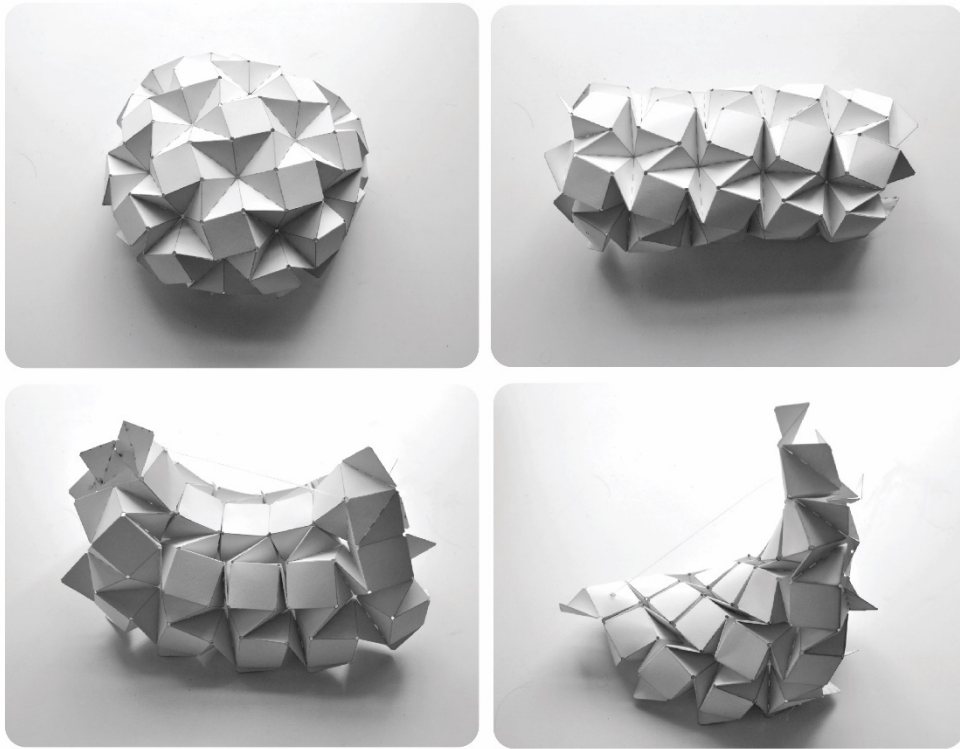

Figure 3. Physical geometric experiments to explore surface curvatures

However once the material properties were implied on the system at the larger scale anticlastic geometries were not considered for further exploration as there was a significant amount of tolerance. The physical experiments were helpful as the results were used to extract the properties into a digital algorithm.

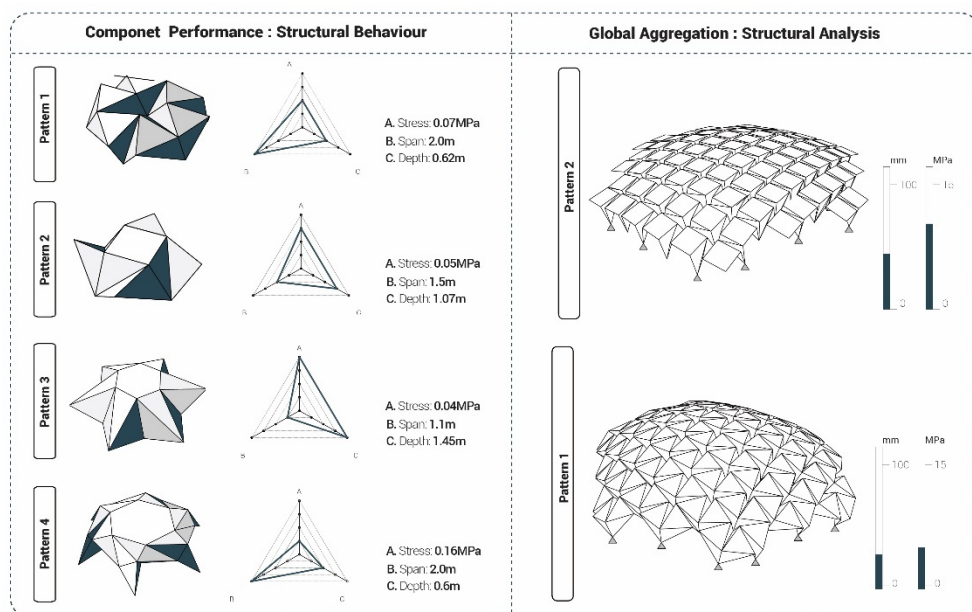

Figure 4. Structural analysis and evaluation at local and global scale

# Reconfigurable Structural Assemblies Using Augmented Reality

## 3. Material System: Structural system and reconfiguration

Once the fundamental geometrical parameters affecting the performance of the system were established through physical and digital experiments; FEA (Finite Element Analysis) software was used to develop an understanding of its mechanical properties. A parametric engineering plug-in was used for extracting the stress lines in the first and second principle directions of surfaces with different degrees of curvature and evaluate the performance of the system. Environmental Analysis was also integrated to define a global surface responding to context, heat gain and rain-water collection. Rules were extracted and integrated into a locking algorithm for defining which areas of the pattern need to be locked in order to achieve defined geometries. FEA results and Environmental analysis were also used to optimise the surface and establish system potentials and limitations in terms of global geometries. The outputs were then used to create a feedback loop between the generative process and performance criteria to arrive upon the assembly logic and details of the structure.

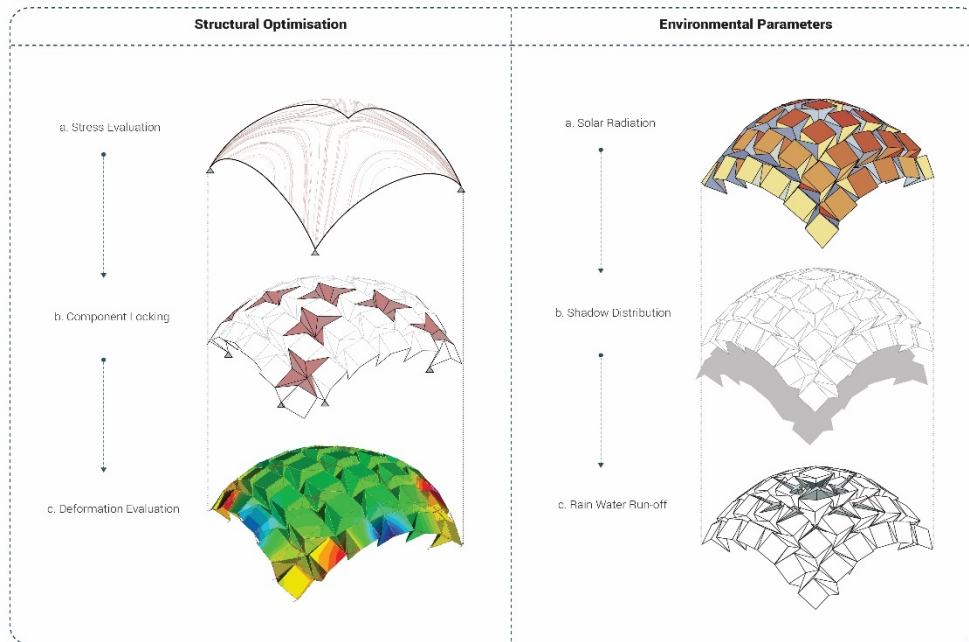

Figure 5. Structural and Environmental optimisation and process

## 2. Aided Assembly and Object Tracking Experiments

The last phase was focused on assembly experiments where object tracking and augmented reality were used as tools to superimpose the abstracted data and overlay it on physical objects via an interface that could guide the assembly and reconfiguration process. These experiments were carried at a local scale to test the applications of the emerging AR (Augmented Reality) Technologies and Global scale to judge the viability of using digitally guided assembly techniques for applications in realistic construction scenarios. It was noted that AR tools proved to be efficient in handling and transmitting data; however presented drawbacks in terms of their hardware and software limitations.



The process involved development of computational tools and interfaces; which were used to integrate digital simulations, generative algorithms, gaming engines and camera tracking to acquire an object's location and rotation data from physical models. A live video feed was sent to custom tools developed by the research team for object tracking and virtual simulation. Assembly data was superimposed on a virtual platform that was further relayed to the user through a display screen. Experiments across multiple scales were conducted to study the various methods of translating digital information into a series of guided physical manipulations. A 1:2 scaled prototype with 4 sq.mt floor plate was assembled using this methods and it was noted that the process was more efficient in terms of time and assembly sequencing. Limitations with the technology in terms of scale an tools were noted down; however the research concludes by stating that such applications have a huge potentials in the Architecture and construction industry.

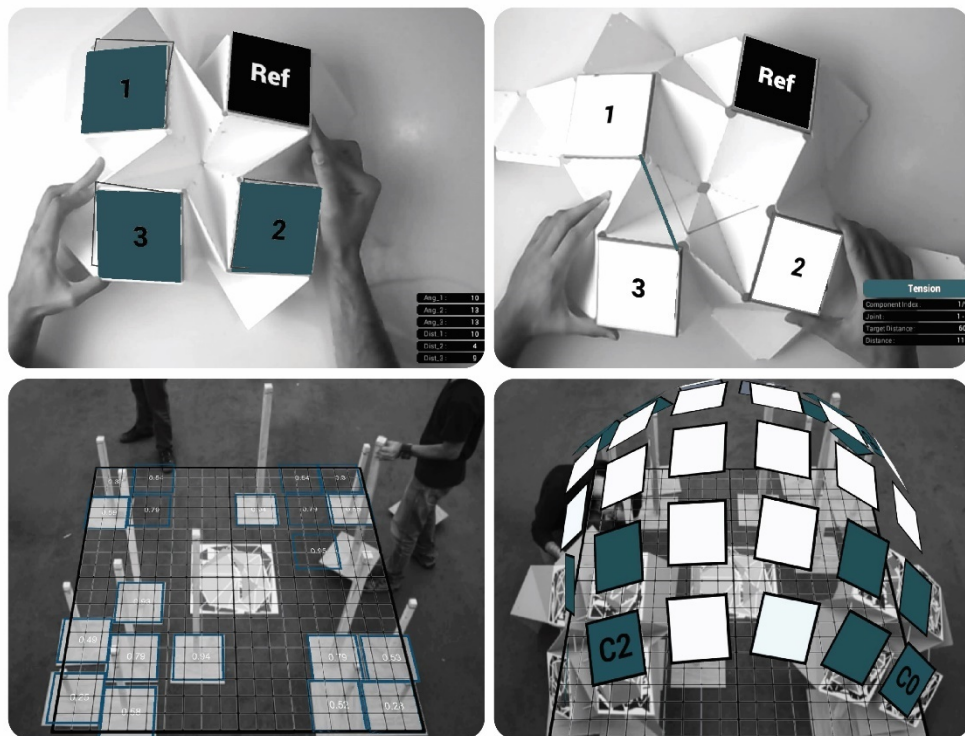

Figure 6. Screen capture of assembly experiments using augmented reality

## 8. Conclusion

Throughout the research Augmented Assembly techniques were tested directly in relation to the chosen folding pattern and all observations were related to the prototype material, experiment setup and the chosen scales. The software was used effectively within controlled environments up to a scale of 200x200 cm and best results were achieved when tolerance allowances were built into the system. It was therefore concluded that it is important that the design of the component itself forms part of the development of a digitally guided assembly sequence. The developed AR process was beneficial in suggesting the correct configuration for each component as well as its final position on the surface. Due to the complex geometrical manipulations required, the setup proved to be efficient in handling the construction information and transmitting it to the assembler. Moreover, through the designed user interface, suggestions

## Reconfigurable Structural Assemblies Using Augmented Reality

about the surface formation were possible through simulations of the assembly sequence, colour indications and projected data through a stationary screen.

The process revealed limitations mostly in terms of object tracking hardware and software used which were not able to function efficiently in poorly lit environments or on larger scales. The camera, image target quality and size were identified as the main issues at the smaller scale tests. Even though a better camera and targets were used in the larger scale assembly experiments, issues with perspective and tracking difficulties restricted its use in larger construction scenarios. The inability to accurately simulate material behaviour digitally also created inaccuracies between the digital and physical worlds. This further affected the accuracy of the assembly experiments as even small differences between the physical and digital models sometimes resulted in configurations which were not possible to achieve. All these factors limited the use of AR in a realistic construction scenario where lighting and background visual noise cannot be controlled. However it was concluded that if temporary controlled environments were to be set up on site, AR technology is capable of relaying the information for the accurate folding of individual components (which would usually only be possible through robotic prefabrication techniques) which could then be aggregated on site using more conventional methods of construction. In this scenario, AR technologies are able to act as a bridge between the factory and the site by extending the capabilities of current methods of construction rather than to replace them.

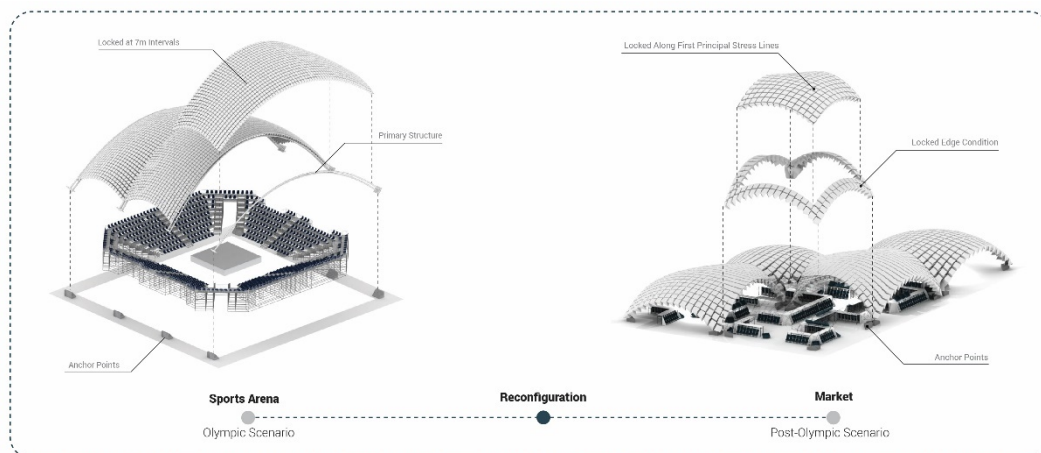

Figure 7. Diagram explaining the transient system which can have multiple uses, and the reconfiguration process which can be mediated by aided assembly techniques.

## Acknowledgements

The research paper contains transcripts from the dissertation “Transient Systems: Exploring Aided Assembly techniques for reconfigurable structures” developed by the authors at the Emergent technologies and Design programme at the Architectural Association in London, UK.

## References

1. Durmisevic E and Yeang K (2009) Design for Disassembly in Architectural Design Special Issue: Patterns of Architecture Volume 79, Issue 6, pages 134–137, November/December 2009, John Wiley & Sons Publications, UK ; ISBN 9780470699591
2. Tang A, Owen C, Biocca F & Mou W (2002) Experimental Evaluation of Augmented Reality in Object Assembly Task: In Proceedings of International Symposium on Mixed and Augmented Reality, Springer Publications, USA; ISBN 9783319210674
3. Gines M & Beorkrem C (2009) The Transformation of Architecture: Design for Dis-assembly: In Proceedings of the 2010 ARCC/EAAE International Conference on Architectural Research, Washington DC, USA; ISBN 9781935129196
4. Engelke W (1987) How to Integrate CAD/CAM Systems: Management and Technology, P.234-238. CRC press ,USA; ISBN 9780824776589
5. Mekni M & Lemieux A (2014) Augmented Reality: Applications, Challenges and Future Trends in Proceedings of 13th International Conference of applied computer and applied computational science, Malaysia; ISBN 9789604743681
6. Azuma R (1997) A survey of augmented reality, In Presence: Teleoperators and Virtual Environments vol. 6, no. 4, pp. 355–385, 1997 ISSN 1054-7460



## Defying Gravity:

*from statics to dynamics, from objects to systems.*

### **Gonçalo Castro Henriques**

*FAU-UFRJ, LAMO, PROURB*

*Rio de Janeiro, Brazil*

*gch@fau.ufrj.br*

### **Andrés Passaro**

*FAU-UFRJ, LAMO, PROURB*

*Rio de Janeiro, Brazil*

*andrespasaro@fau.ufrj.br*

**Abstract:** In the cold space of information objects drift in the void. All is abandoned in junk space or fiercely organized. The difference between an object as a form and formations - or interacting populations of elements in an environment - is still disregarded. In Cartesian space objects are preconceived by an external observer, in static and timeless space. In parametric space Euclidian geometries persist as preconfigured objects. The flux of information between physical and digital realities is still archaic: is done with effort, demanding physical strength and time. There is low interaction between physical and digital realities. Seems like a dystopian reality in a past-future. The theory of relativity asserts that space and time are interdependent, being modified and modifying us. In organic and synthetic biology, form results from the dynamic interaction of elements. This Research argues that form and environment are interdependent in physical and digital dimensions. A two-part applied research method is proposed: preliminary research and further development via workshop. Preliminary research identified the knowledge areas involved, defined problem search space and tested methods and techniques to solve it. The successfully developed design methodology - combining the preliminary research and workshop - can be used to solve future design problems.

**Keywords:** *Responsive systems; physical and digital interaction; algorithmic design; applied research.*

## **1. Motivation and context**

Man has long defied gravity by building. New technologies bring new technical possibilities and processes to build, but also new concepts. In order to incorporate this reality in project and surpass pure instrumentalization, an applied research project is proposed. The research is divided into two parts: preliminary research on a topic developed via a workshop. This workshop continues the challenge of overcoming the attitude of 'technique via technique' that began in a previous workshop, «sensitive shelters» (Passaro & Henriques, 2015). In this intensive workshop, the LAMO group and invited tutors defined the workshop context and guided participants in the conception, development and materialization of a responsive project.

The workshop «defying gravity» aimed to create responsive systems. It started by showing how to surpass the conception of form as an isolated object, considering form as result of the interaction of parts in a system. It also explained how this principle can be used to developed mechanisms that interact with the user. The participants received training in generative design

(CAAD), digital fabrication (CAM) and digital interaction (Arduíno), necessary tools to create, fabricate and operate a responsive structure.

## 2. Problem and methodology

To obtain responsive buildings one must consider the interaction between form, information and environment. To overcome considering objects as isolated entities and to start consider them as systems required the evolution of physics, mathematics. It required the transition from restricted causality to multi-causality, from the determinist approach to the probabilistic rationale. The study of these phenomena demands theoretical, but also practical knowledge. Any given solution depends on the techniques and processes used, but also on the way in which they are formalized and in which scale and material.

The preliminary research aimed to overcome the complexity of the theme by systematizing the problem and identifying methods and techniques to solve it, defining the solutions space. Preliminary research and the foundation of the workshop methodology lasted about two months receiving the collaboration - beyond this paper's authors - of Elisa Vianna, Rebeca Estrada, Clarice Rohde, Carina Carmo, Vitor Sardenberg, Ernesto Bueno, Verônica Natividade, Lucas de Sordi, Daniel Lenz, Marlus Araújo, and LAMO monitors: Roberto da Costa, Gabriel Gaspar, Helena Burock, Julia Nodari, Camila Bueno, Thiers Freire, Vinícius Lucena, among others. The research established a conceptual and operative framework gathering knowledge from the fields of architecture, systems theory, computation, robotics, interaction, digital fabrication, mechanics, and others. A common work base was obtained through group interaction that went beyond the sum of the individual member's capacities.

## 3. Theoretical and technological framework

The theoretical and practical foundation - tools and processes - were established in the preliminary research to develop responsive systems.

### 3.1 Form, information and environment

The geometric definition used influences the way we design. Digital and computational processes support new types of geometries, based on new mathematical definitions.

| <b>Cartesian Space</b>   | <b>Topological Space</b>     |
|--------------------------|------------------------------|
| Euclidian geometry       | Associative geometry         |
| Discrete elements        | Parametric multiplicity      |
| Regular ideal form       | Fluid continuous form        |
| Global infinite space    | Local dimensional space      |
| Neutral space            | Relational space of forces   |
| Continuous time (Newton) | Simultaneous time (Einstein) |
| Isometric operations     | Topological transformations  |

The above chart synthesizes the differences between the Cartesian and topological space (Henriques, 2015). The Euclidian conception of form and space is different from hyperbolic

## **Defying gravity: from statics to dynamics, from objects to systems.**

geometry and space, or parametric space. The translation of this geometry into physical form depends on the tools used and the way in which they are used. The interaction between objects depends on how their relations are defined and how they are represented. Technological evolution is a challenge to reformulate the design methodologies.

### **3.2 From form to formations**

From static forms to dynamic environments, from form to formations. The objectual vision of form as an isolated object or as an articulated set of parts is associated with the development of the system concept. An overview of responsive systems was presented to the participants and shall be summarized.

General Systems Theory and Cybernetics brought new mathematical contributions to the system definition. The General Systems Theory, developed by Von Bertalanffy (1952-1968), was a reaction to reductionism and restricted causality, promoting holism and multi-causality. It supported the concept of an organism in which the whole is greater than the sum of its parts, leading to the development of general mathematical laws of systems, be them natural, artificial, social, etc. Gordon Pask (1969) contributed to this field with the development of Cybernetics, or the theory of control systems.

An explanation was given of how Bertalanffy defines the simple feedback mechanism and how Pask defines goal-oriented mechanisms. From the Cartesian definition of objects in an infinite space to topological geometry, there is an evolution with the use of associative mathematics to support relations between geometric elements. In the Cartesian space each object is defined in isolation in a infinite space. In topological geometry, on the contrary, local spaces can be defined as surfaces composed of interrelated components that form a system. Thus, according to the space frameworks used, design results can change. Newtonian physics, which considers objects as separate entities, can be surpassed by laws of physics that consider «force fields» and the interpolation between parts and the whole. These definitions allowed passing from neutral and static space to a dynamic and relational environment.

## **4. Preliminary applied research**

### **4.1 Interaction diagrams**

After studying the fundamentals and finding examples of system development, it was necessary to find a method to test them in practice. To develop systems, it is necessary to define the interaction between the parts and the whole. An attempt was made to capture the interaction between form(s) and determined movements, translating this interaction graphically through diagrams. The idea of using generative diagrams was developed in the previous workshop, «sensitive shelters». These diagrams were discussed and fine-tuned by the group in an interactive process. The analysis of the types of interaction made it possible to define categories of movement and perfect the diagrams. The diagrams are the foundation on which algorithmic and physical mechanisms were developed. The mechanisms were translated digitally (sensors-actuators) and analogically through physical transmissions (gears). With the development of

corresponding hardware and software, an attempt was made to mitigate the physical- digital separation. The chosen diagrams synthesize an action (verb): detaching, lifting, rolling, unfolding and wrapping.

The translation of the diagrams into algorithms made it possible to investigate solutions and identify difficulties. The algorithmic research was coordinated and developed by Gonçalo Henriques, Ernesto Bueno and Verônica Natividade. Throughout this process algorithm definitions bounded to the diagrams were prepared. Here, it was not a matter of anticipating solutions, but an endeavour to study ways of solving problems. The exercises proposed for the participants were based on these findings. This procedure differs from the majority of architectural workshops on visual programming in which learning is based on resolving generic exercises.

The translation to physical and analogical mechanisms was developed by Lucas de Sordi, Daniel Lenz and Marlus Araújo. Their work mapped possible types of mechanisms and defined the material needed for the workshop. The algorithmic and material mechanisms were developed in parallel with the movement diagrams.

#### 4.2 Mechanisms and emergent systems

The articulation between the parts of a system is performed through mechanisms. Holland defines a mechanism as an apparatus that responds to actions (data input) by processing them and, as a result, produces actions (data output). This definition is related with Bertalanffy's definition of a system. Holland provides a description of mechanisms that cites examples ranging from the Ancient Greeks (simple levers), to the Arabs (clocks and toothed mechanisms), to computation processes (Conway's game of life).

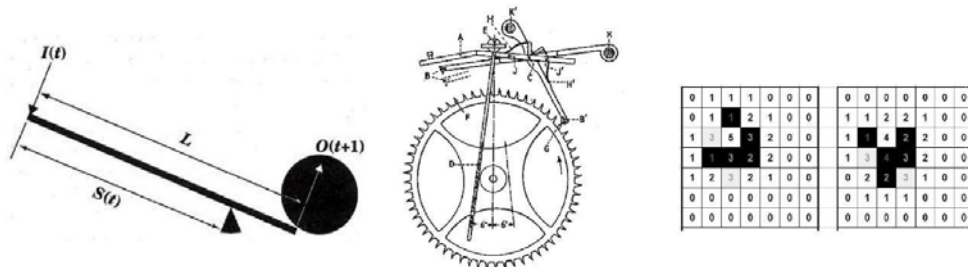

Figure.1 Mechanisms: parametrically defined lever (Holland); geometric representation of watch with pendulum and grasshopper mechanism (Harrison); cellular automata (Conway).

The mechanisms presented in the figure possess different logics and representations. The first is the lever, which exists since Ancient Greek times, but is translated by Holland into a formula that acquires several outcomes (or states) according to the given parameters. The second mechanism is associated with Huygens's description of pendulum orbits (XVII century). The pendulum is described geometrically as a mechanism based on the movement generated by its own weight, which drives the "grasshopper tweezers" that drives the clock's toothed wheels. The third mechanism is based on cellular automata, which translates analogic rules into digital rules with emergent outcomes.

Materials possess rules that, when translated explicitly, can become mechanisms with states and through interaction can provide emergent outcomes. An example of this methodology

## **Defying gravity: from statics to dynamics, from objects to systems.**

is Achim Menges's research at Stuttgart University. Due to the complexity involved in generative processes of mechanisms, some examples were shown. Static material systems can have also the potential to move, acquiring different states by developing simple mechanisms. The theory of emergence, proposed by Johnson, Holland or Weinstock, among others, was cited as a reference of form generation. Accordingly, through the combination of simple local conditions complex processes can emerge that cannot be predicted by the sum of the parts' properties. Weinstock highlights the mathematical foundation of emergence theory and Holland displays these principles in computation.

### **4.3 Development of the workshop**

The workshop lasted 8 days, and included 20 participants and 5 tutors. In the first days there were lectures and simultaneous training on algorithmic design (grasshopper), digital fabrication, interactive networks (sensors and Arduino) and digital-analogical gears (forces and movements).

Each of the four groups of participants chose one of the diagrams as a starting point. Each project associated the movement with a stimulus, defining an action-reaction principle. Stimuli chosen were human proximity, light, sound, magnetism, etc. Each stimulus should have its feedback so the form could readjust; if light provokes the opening of a form, its absence should provoke its enclosure. The interaction with the users depends on physical properties such as density/lightness, permeability/opacity and the aggregation/expansion capacity of its parts as a whole.

The following steps were proposed to develop the projects: 1- Movement diagram; 2- definition of Geometry/Materiality, defining the primitives (components) and the material; 3- definition of the stimulus associated with the diagram (light, sound, humidity, temperature); 4- pseudo code of the interaction process. Each group created a system and produced a functional analogical-digital model of a responsive surface with the maximum dimension of 50x50x50 cm.

## **5. Workshop results**

Group 1 chose the detachment movement. The "sand labyrinth" project proposes a moving landscape according to human proximity. The stimuli are detected through movement sensors (the software input) which, generates values to transform surfaces transmitted to toothed gears beneath the surface. Different human location corresponds to different software states. One of the greatest challenges was defining the adequate ground geometry, finding a material logic for the components to enable the surface's movement as a whole. The advantage of using polygonal meshes and NURBS was discussed.

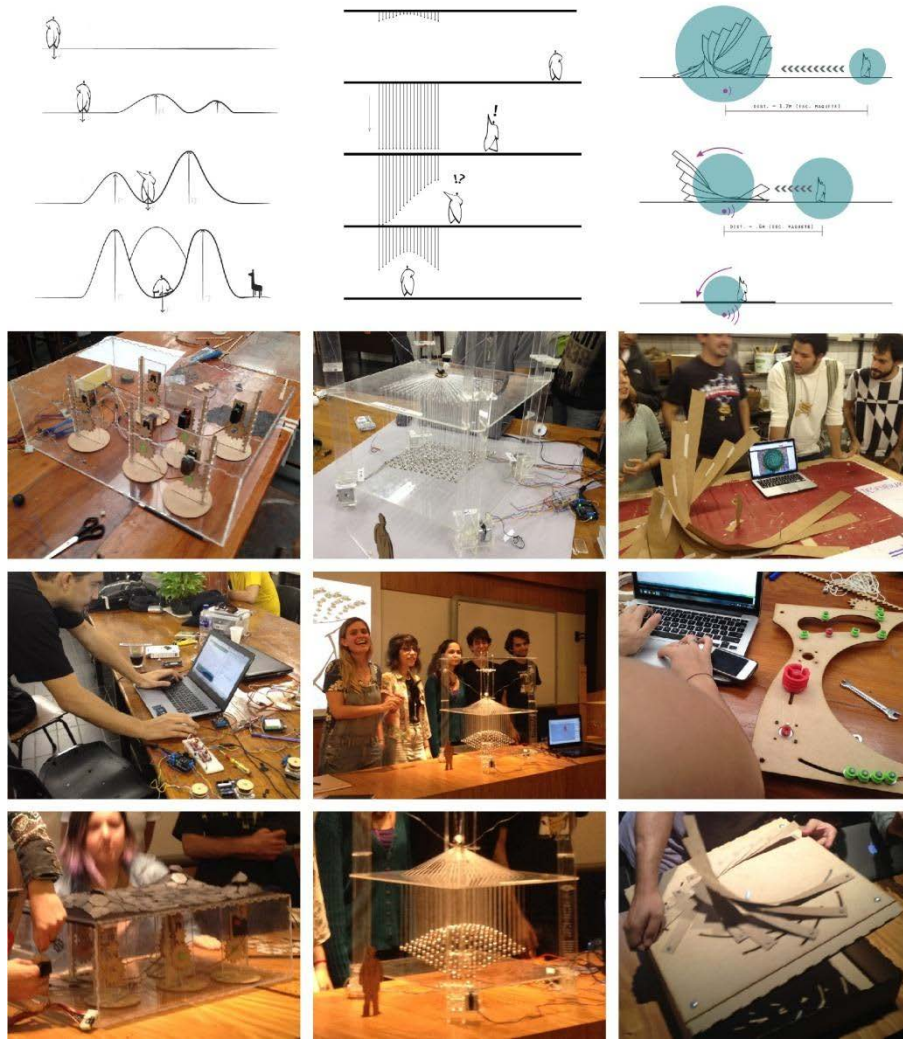

Figure. 2 Each of the workshop's groups chose a diagram of ground movement, created a narrative of their project, and developed a responsive system. Groups from left to right: G1, G2, G4.

Group 2 chose the lifting movement, defining particles system named "rain" reacting to human presence. A process was developed to control a cloud of particles (or drops) through a single point. An analogical mechanism controls the cloud through a central anchor point, using four motors to control its motion. The cloud of points is mapped in a convex hull, and the shape of the hull changes according to human presence. The position of the points is defined by local surface equations. The system defined three zones and behaviour states associated with preset distances. The data is transmitted by sensors to the Arduino chip, which sends the signal to the algorithm that calculates the particles' position, and sends the position information back, triggering the motor system to adapt the cloud configuration. The system succeeded in attaining an elegant and fluid analogical-digital movement.

Group 3 chose unfolding to define a dimensional space of two surfaces creating a "wormhole". Using a touchpad the articulation of both surfaces can be modified using a parametric definition. The surface information is transmitted to a toothed wheels mechanism changing the physical form to match the touchpad screen. The surface movement results in the displacement of a magnet causing the magnetic attraction or repulsion of metallic components on the surface.

## **Defying gravity: from statics to dynamics, from objects to systems.**

Group 4 wrapped the ground as a plant reacting to daylight change, in a “Neo-nastia”. This digital-analogue plant receives light input in sensors, changing its form by wrapping itself up in an incremental orbit, following the Fibonacci sequence present in the growth of many plants.

### **6. Discussion about applied methodology**

Since man started constructing, he uses technology to create a new ground. He organizes space establishing a new order, in contrast with natural disorder. Vitruvius included war machines in his treatise on architecture. However, nature has long been studied as a machine too. With the development of systems theory and Cybernetics, the interaction between natural and artificial systems receive more attention. The challenge of the research was to define changeable surfaces made of components that would interact with man, in space and time. The chosen materiality and geometry influences the relationship between these surfaces and their context, as well as their software mechanisms. These mechanisms attribute a new vitalism to material, attaining an alive animism. Considering that the majority of the participants had no previous experience, the workshop results are promising. They also suggest that this new methodology – identifying theoretical and practical references and testing them via workshop – can be used to solve other project related problems.

### **Acknowledgements**

Research support by CNPq, CAPES, FAPERJ, PROURB and LAMO.

### **Workshop credits**

Coordination: Andrés Passaro & Gonçalo Castro Henriques. Organization: Elisa Vianna, Rebeca Estrada, Clarice Rohde, Carina Carmo, colaboration Victor Sardenberg. Lectures: Gabriela Celani, Arthur Lara & tutors. Tutors (Code) Gonçalo Henriques, Ernesto Bueno, Verônica Natividade (Interaction), Lucas de Sordi, Daniel Lenz, Marlus Araújo. LAMO: Helena Burock, Julia Nodari, Thiers Freire, Vinícius Lucena. Participants: Thomaz Vieira, Lina Lopes, Isadora Tebaldi, Camila Rodriguez, Raquel Leite, Bernardo Amaral, Gabriela Bonifácio, Caio Cavalcanti, Camila Torres, Marinah Raposo, Roberto Matta, Vanessa Rosa, Loan Tammela, Cintia Melchior, Dimmy Trindade, Aline Furtado, Anael Alves, Lia Guerra, Maria Rúbia, Branca Leibovich, Carlos Saul, Gabriel Gaspar. Photos: Nicholas Batista, Laura Lago.

### **References**

Alexander, Christoph, “System Generating systems”, em Architectural Design, December Issue No 7/6, John Willey & Sons Ltd, Londres 1991, pp. 90-1.

Bertalanffy, Ludwig Von, General System Theory: Foundations, Development, Applications, George Braziller, Nova Iorque, 1969.

Henriques, Gonçalo Castro; "Sistemas responsivos: relevância, estado da arte e desenvolvimentos", XIX SIGraDi, Informação Projeto para interação, Alice Pereira e Regiane Pupo (eds), Blücher, pp. 200-6, DOI 10.5151/despro-sigradi2015-60042

Holland, John, Constrained Generating Procedures, Emergence: From Chaos to Order, Perseus Books (Reading, MA), 1998, pp 125- 42.



## Gonçalo Castro Henriques, Andrés Passaro

Menges, Achim, AHLQUIST, Sean, Computational Design Thinking, John Willey Sons Ltd, Chichester, Reino Unido, 2011.

Pask, Gordon "The Architectural Relevance of Cybernetics", em Architectural Design, September issue No 7/6, John Wiley & Sons, Londres, 1969.

Passaro, Andrés; henriques, Gonçalo Castro; "Abrigos Sensíveis, do método ao conceito, superando a instrumentalização", XIX Congresso SIGraDi, Informação Projeto para interação, Alice T. Pereira e Regiane Pupo (eds), Blucher Publishing, pp. 94-100, DOI 10.5151/despro-sigradi2015-30155.

# Exploring Buildings' Surface Patterns

**Inês Caetano**

*INESC-ID/IST*

*Lisbon, Portugal*

*Ines.caetano@tecnico.ulisboa.pt*

**António Leitão**

*INESC-ID/IST*

*Lisbon, Portugal*

*antonio.menezes.leitao@ist.utl.pt*

**Abstract:** Facades characterized by complex shapes and patterns benefit from the use of Generative Design (GD), which promotes design exploration. However, GD requires the development of algorithms, which can be far from trivial for architects. To simplify this process, we propose DrAFT, a computational framework for the generation and exploration of buildings' surface patterns, which is based on a classification of facades that helps architects identify the algorithms that best suit their design intent. After combining the algorithms provided by DrAFT, designers can more easily explore the solution space of their design ideas, allowing for continuous improvement in the design process.

**Keywords:** *generative design, facade design, algorithms, framework*

## 1. Introduction

Architectural creativity requires a design process that embraces change (Bukhari, 2011). Unfortunately, traditional design tools require too much time and effort to change models. On the other hand, new technologies allow further design exploration, promoting the emergence of more complex shapes, details and patterns (Moneo, 2001), which were difficult and costly to produce until recently. In fact, architects have not rediscovered complex forms, they rather found new possibilities to generate and construct them (Kolarevic, 2005). These innovations have had a large impact in the exploration of facade designs, since they allow the generation of shapes and patterns that would not be viable to produce manually (Kolarevic, 2003). Nevertheless, there are still some limitations in the architectural practice, mainly in the production of more complex designs.

## 2. Algorithmic Approaches to Design

As Woodbury stated (2010), new technologies brought “fresh and needed new capabilities” to the human enterprise of design. Generative Design (GD) is a design process where the output is generated with the help of a computer and through the use of algorithms (Terzidis, 2003). GD not only allows architects to quickly generate, compare, and evaluate multiple solutions, but it also enables the manufacturing of complex solutions.

GD requires algorithms implemented in programming languages (Leitão, 2014). Integrating algorithmic thinking and programming techniques into the design process requires an initial investment but it provides considerable returns in later design phases (Woodbury, 2010).

Parametric Architecture is a design approach based on algorithmic thinking, in which a set of parameters and rules encode and define the relationship between the design intent and design response (Jabi, 2013). The constituent geometry is mutually linked (Burry, 1999), where architects design a set of principles encoded as a sequence of parametric equations, which then generates the model's design and also changes it when needed.

### 3. Background

GD is being used in the production of digital ornament and complex building skins, which are visible in many contemporary buildings. Some authors have already studied a variety of facade designs, creating different classifications to synthesize and organize contemporary facades into different typologies (Moussavi, 2006; Pell, 2010; Velasco, et al., 2015). However, none of the previous classifications intends to help architects with the algorithmic description of new facade designs which might still require a lot of effort to invent, experiment, and produce.

In the past, we proposed a classification of facades based on a computational approach, which identifies algorithms and strategies that address the needs of different designs (Caetano, et al., 2015). We started with an extensive analysis of contemporary building skins, which was followed by an algorithmic description of some of them in order to recreate the corresponding models. This process helped us realize the existence of similar algorithmic structures (algorithmic patterns) within this variety of facade designs, which means architects can reuse the algorithms to generate further designs. This was also recognized by (Su & Chien, 2016).

In this paper, we present an updated classification that better matches the development process used in the implementation of new facade designs.

### 4. Buildings' Surface Patterns Framework

Architectural practice is highly dependent on the specific circumstances of the design brief and, thus, it is unlikely that the exact same approach can be used in a different project. Nevertheless, modular programming techniques allow the designer to adapt and reuse ideas in different projects which imply, at least partially, that the systematic application of these techniques reduces the initial investment required.

If these techniques were available at the early stages of facade design exploration, architects would spend much less effort in the programming task, since they would not have to rewrite from the scratch all the algorithms every time they started a new design.

#### 4.1 DrAFT Framework

In our previous work (2015), facades were classified into different categorical dimensions that we considered algorithmically relevant, namely *Facade Geometry*, *Elements Geometry*, *Elements Size*, *Elements Distortion*, *Elements Rotation*, *Elements Distribution*, *Facade Articulation* and *Material & Color*. For each dimension, we developed several algorithmic functions and operators, covering a wide variety of design solutions. Draft Algorithmic Facades Tool (DrAFT) is a framework based on this classification, which guides the designer in the identification

## Exploring Buildings' Surface Patterns

of the functions and operators that best suit his design intent, allowing further design exploration and easier adaptation to the ever-changing design process conditions.

### 4.2 An Improved DrAFT

After having used DrAFT for more than one year in the exploration of various facade designs, we found that an improved classification was needed, one that better reflects the development process used in the implementation of new facade designs. This classification is based on four main categorical dimensions: A) *Facade Geometry*, which defines the facade's surface geometry; B) *Elements*, which generates the facade's elements; C) *Distribution*, to distribute the elements along the facade's surface; and D) *Articulation*, which defines the appearance of the facade. These four main dimensions are then subdivided to deal with more specific details of each design stage.

In the next sections we discuss each of these dimensions.

#### 4.2.1 Facade Geometry

The Facade's Geometry dimension is used to describe the shape of the facade's surface. This shape is specified by a  $\mathbb{R}^2 \rightarrow \mathbb{R}^3$  function. For example, a five-by-ten rectangle on the XZ plane can be described by  $S(u, v) = XYZ(u \times 5, 0, v \times 10)$ , where XYZ is the Cartesian coordinate function. Other coordinate systems can be used, such as the Cylindrical, represented by function CYL, and the Spherical, represented by function SPH, to which can be applied Euclidean transformations. To simplify the presentation, each parametric function  $S(u, v)$  will range over the domain  $0 \leq u \leq 1, 0 \leq v \leq 1$ .

To make the framework more intuitive, several kinds of surfaces are predefined as higher-order functions (HOFs), i.e., functions that receive other functions as arguments and/or compute other functions as results (Leitão, 2014). We also make liberal use of anonymous functions, which, following the terminology of the  $\lambda$ -calculus, we will represent by the letter  $\lambda$ .

As an example, our five-by-ten rectangle can be described by the function application  $Straight(5, 10)$ , where  $Straight$  is defined by (1):

$$Straight(w, h) = \lambda(u, v). XYZ(u \times w, 0, v \times h) \quad (1)$$

It is also possible for the designer to define additional functions. To this end, we also provide a set of functional operators that can be arbitrarily combined. One such operator represents a one-dimensional linear variation:  $L(a, b) = \lambda(t). a + (b - a)t$ . Another, represents a (paradoxical) constant "variation":  $C(c) = \lambda(t). c$ .

Given that the facade geometry domain is two-dimensional, it is also useful to extend the domain of the above one-dimensional variations into  $\mathbb{R}^2$ . To this end, we define  $D_u(f) = \lambda(u, v). f(u)$  and  $D_v(f) = \lambda(u, v). f(v)$ . A final but important operator is the generalized composition of functions:

$$\circ(f, g_1, \dots, g_n) = \lambda(x_1, \dots, x_m). f(g_1(x_1, \dots, x_m), \dots, g_n(x_1, \dots, x_m)) \quad (2)$$

In order to simplify the notation, we define  $a \otimes b = D_a(L(0, b))$ , we treat all numbers  $n$  that occur in a function context as  $C(n)$ , and we treat any ordinary first-order function  $f$  that is used

with functional arguments  $g_1, \dots, g_n$  as  $\circ(f, g_1, \dots, g_n)$ . As an example, the *Straight* function presented above can be equivalently defined as

$$Straight(w, h) = XYZ(u \otimes w, 0, v \otimes h) \quad (3)$$

For a different example, consider the sinusoidal facades which are common in recent architecture. The sinusoidal HOF is:  $sinusoid(a, \omega, \phi) = \lambda(x). a \times \sin(2\pi\omega x + \phi)$ , where  $a$  is the amplitude of the sinusoid,  $\omega$  is the angular frequency, i.e. the number of cycles per unit length, and  $\phi$  is the phase. A facade that represents a horizontal wave in the XY plane is then defined by function (4):

$$Sb(w, h, a, \omega, \phi) = XYZ(u \otimes w, D_u(sinusoid(a, \omega, \phi)), v \otimes h) \quad (4)$$

On the other hand, there are facades with completely irregular shapes, which are classified in the Facade's Geometry dimension as Free-Form. In this last case, the designer creates the shape manually, and imports it into our framework where it is represented as another parametric function that results from an interpolation process.

#### 4.2.2 Element

Most facade designs or patterns are created by the repetition of a certain unit, which can be kept unchanged along the facade's domain or can be changed in relation to its shape, size, etc. We name these units as *Elements* and our second dimension is in charge of generating them. For this, we merged the dimensions *Element's Geometry*, *Size*, *Deformation* and *Rotation* into this one, and we also added some more features. We sub-divide this dimension *Element* into *Shape* and *Transformations* groups. The first group provides a set of functions that generates different shapes. The second group provides a set of operations that deals with different kinds of transformations, including contraction, expansion, dilation, reflection, rotation, shear, twisting, bending, interlacing, and combinations of these.

In practical terms, the facade element is implemented with a HOF that takes other functions as arguments, representing the different characteristics of the element (including shape and shape transformations).

After selecting the facade's geometry and the element's geometry, it is time to combine them to define the complete facade. One of the advantages of the functional representation is that it makes this combination a trivial composition of functions. As an example, a straight facade with spherical elements of radius  $r$  is defined by  $sphere(Straight(w, h), r)$ . The result is a continuous function that generates spheres on a  $w \times h$  rectangle on the XZ plane. The next section discusses the actual distribution of spheres.

#### 4.2.3 Grid Distribution

In the previous sections, we described the functional description of the facade geometry and of its elements. Although this description is a continuous function, most facades are discretized, which means that the functional description of the facade is mapped, not on a continuous domain, but on a discrete domain, obtained by a sampling process. This process characterizes the Grid Distribution dimension, which deals with the placement of the elements

## Exploring Buildings' Surface Patterns

along the facade. This is accomplished by a discretization function  $sample(f, n, m)$  that, given the  $f$  function defined in the domain  $[0,1] \times [0,1]$ , and the intended number of samples in the two dimensions, computes the bi-dimensional sampling of  $f$ . There are many different ways to do the sampling process (regular grid, hexagonal grid, chess-grid, etc.) and each of these will produce a different kind of facade. An additional feature to consider is the influence of the *metric* of the facade's surface on the elements' shape or size, so that these adapt to the distortions of the facade. To this end, we include an additional step that combines sampled values into a virtual quadrangle whose vertices define a *patch* used to adjust each surface element. This adjustment can also be controlled by the presence of one or more attractors.

### 4.2.4 Facade Articulation

The same surface with the same elements and grid distribution can originate different aesthetic results according to how they relate or the material used. Articulation is the way of jointing the different parts in order to create the final facade. This can be done through the use of materials, different techniques applied on the buildings surfaces (Pell, 2010), or by the means of architectural patterns (Schumacher, 2009). Therefore, we considered as sub-dimensions: i) material used, ii) different techniques (perforations, stacked, applied, etc), and iii) depth of the facade pattern (number of layers, web effect, etc).

These sub-dimensions provide a range of functional operators that, after being selected by the user, are combined in the HOF *articulation* along with the functions from the other main dimensions: *facade-Geometry*, *element* and *distribution*.

## 5. Evaluation

In this section, we develop two facade designs using our framework. We explain the whole generation process starting from the classification of facades until the selection and, then, combination of the functional operators and algorithms. As a result, the obtained combination of functions generates the corresponding facade design, on which we can apply several variations.

The first example, visible in Figure 1, is inspired by the Nolan Building facade in Melbourne (by PLUS Architecture). It has a sinusoidal shape and is composed by squared elements distributed in a regular-grid and showing two transformations: a horizontal randomly-controlled rotation, and a vertical rotation that increases with the facade's height. These elements are then applied on the facade's surface. This classification determined the algorithms that we combined to create the facade's model.

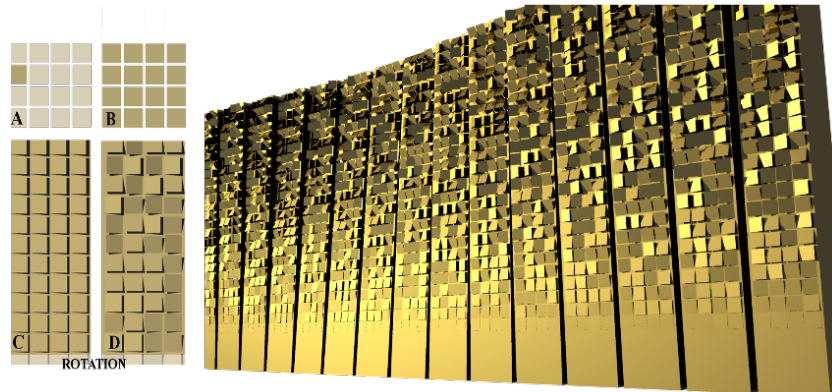

Figure 1 – Nolan Building facade model. On the left: the algorithms combined to produce the model (A- Element; B- Grid Distribution; C/ D – Element Transformation and Applied Articulation); On the right: the generated model.

The second example was inspired by the facade of the Louis Vuitton store in Shenzhen. This facade has a regular shape and is composed by squared elements whose size decreases with the facade’s height. Their distribution is in chess-grid and they are applied on the facade’s surface.

After combining the provided algorithms and, thereby, generating this facade model, we can experiment some design alternatives. Figure 2 summarizes this process and shows three possible design variations that were produced by changing the geometry of the element or its size variation.

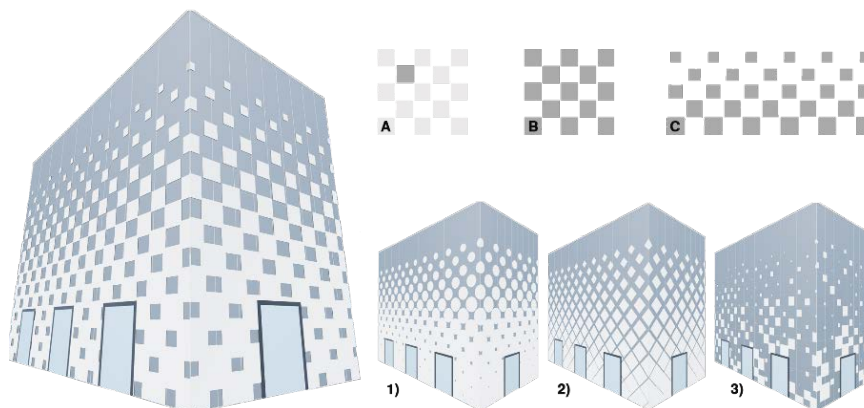

Figure 2 – Left: model based on the Louis Vuitton store facade; Top (A-C): the algorithms combined to generate the model (A- Element; B- Distribution; C–Transformation); below: three design alternatives. In 1) and 2) we changed the element’s shape to circular and to diamond-shape. In 3) we used a random size variation.

## 6. Conclusions and Future Work

GD promotes design exploration but requires that architects spend time and effort in the algorithmic description of their designs. Were architects able to take advantage of modular programming techniques, they could adapt and reuse some pre-defined algorithms in new projects, which would reduce their initial investment.

In this paper we presented an improved framework for facade design - DrAFT. Our framework is based on a simple and flexible classification scheme that addresses the needs of architects designing facades. The classification is divided into four main dimensions, each



## Exploring Buildings' Surface Patterns

representing a stage of a facade design, which are then further subdivided to deal with a wide range of design characteristics in each design stage. For each subdivision, we propose a set of algorithms implemented as functions or functional operators. Depending on the number of algorithms selected (or implemented) from each dimension, the more or less customized the facade design will be.

In practical terms, the composition of the algorithms within DrAFT facilitates the algorithmic description of facade designs and allows the experimentation and variation of the generated models. DrAFT is implemented using the Rosetta IDE (Lopes & Leitão, 2011), allowing its exploration with different programming languages and different CAD and BIM applications.

Our case studies demonstrated the simplicity of using DrAFT not only to produce a facade model, but also to easily change its design.

In the near future, we plan to expand the set of available algorithms and we are particularly interested in conducting a wider field study of its application in real situations, including its extension to manufacturing.

### Acknowledgements

This work was partially supported by national funds through Fundação para a Ciência e a Tecnologia (FCT) with reference UID/CEC/50021/2013.

### References

- Bukhari, A. F., 2011. *A Hierarchical Evolutionary Algorithmic Design (HEAD) System for Generating and Evolving Buildings Design*, Queensland University of Technology: Built Environment and Engineering, School of Design.
- Burry, M., 1999. Paramorph. In: *Hypersurfaces 2: Academy Editions*, pp.78-83.
- Caetano, I., Santos, L. & Leitão, A., 2015. *From Idea to Shape, from Algorithm to Design: A Framework for the Generation of Contemporary facades*. São Paulo, Brazil, The Next City: 16th CAAD Futures, CCIS 527, Springer.
- Jabi, W., 2013. *Parametric Design for Architecture*. London: Laurence King Publishing.
- Kolarevic, B., 2003. *Architecture in the Digital Age: Designing and Manufacturing*. London: Spon Press.
- Kolarevic, B., 2005. Towards the Performative in Architecture. In: *Performative Architecture: Beyond Instrumentality*. NY: Spon Press, pp.203-214.
- Leitão, A. M., 2014. *Improving Generative Design by Combining Abstract Geometry and Higher-Order Programming*. Kyoto, 19th CAADRIA.
- Lopes, J. & Leitão, A., 2011. *Portable Generative Design for CAD Applications*. Calgary, Canada, ACADIA.
- Moneo, R., 2001. The Thing Called Architecture. In: *Anything by C. Davidson*. New York: Anyone Corporation, pp.120-123.
- Moussavi, F., 2006. *The Function of Ornament*. ACTAR.
- Pell, B., 2010. *The Articulate Surface - Ornament and technology in Contemporary Architecture*. Birkhauser.
- Schumacher, P., 2009. Patterning Parametrically. *Architectural Design: Patterns of Architecture*, Volume 79, N°6 (Nov/Dec), pp.28-41.

Su, H.-P. & Chien, S.-F., 2016. *Revealing Patterns: using Parametric Design Patterns in Building Facade Design workflow*. Melbourne, Australia, 21st CAADRIA.

Terzidis, K., 2003. Introduction. In: *Expressive Form: A Conceptual Approach to Computational Design*. NY: Spon Press, pp.1-8.

Velasco, R., Brakke, A. P. & Chavarro, D., 2015. *Dynamic Façades and Computation: Towards an Inclusive Categorization of High Performance Kinetic Façade Systems*. São Paulo, Brazil, CAADFutures, CCIS 527, Springer, pp.172-191.

Woodbury, R., 2010. *Elements of Parametric Design*. NY: Routledge.

## Uthopia: Digital Fabrication of Non-Built Architectures

**Fernando  
García Amen**

*Universidad de la  
República*

*Montevideo, Uruguay*

*efe@farq.edu.uy*

**Marcelo  
Payssé Álvarez**

*Universidad de la  
República*

*Montevideo, Uruguay*

*paysse@farq.edu.uy*

**Víctor  
Varela Vargas**

*Universidad de la  
República*

*Montevideo, Uruguay*

*vicvarq@farq.edu.uy*

**Abstract:** The main goal of this paper is to walk through an explanation of workflows developed to achieve digital production from different imagined but never built architectural realities. It refers to a project called "uthopia; the unbuilt" developed by the Laboratorio de Fabricación Digital Avanzada (LabFabMVD). It aims to revalue the heritage of many authors utopic ideas, and to reinterpret them through digital processes in digitally fabricated realities.

**Keywords:** *digital fabrication; utopia; heritage; drawing; interpretation*

### 1. Introduction

The realization of a utopia is, conceptually, an enormous challenge. The consideration of someone else's utopia, also involves the extra difficulty of understanding the intentions of its creator, in major cases with little available information. This is the main premise that is proposed in this paper: to implement a technology able to interpret, digitalize and fabricate utopian projects from a single graphical input: a drawing.

Thomas More, to conceive in his eponymous work his own "Uthopia", dissected it from its nominal definition as "what is nowhere". This concept, so linked to imagination and creativity, has nurtured several authors. These authors, using conventional graphical tools have created megalomaniac, fantastic, improbable or even impossible architectural realities. Realities that, subject to time and their assimilation into the global cultural heritage, became iconic for the study of a particular artistic trend, a stylistic definition or a particular period.

This work proposes the study of four specific works, each of which, by its nature, represented in its time and even now some utopian ideals and paradigms of different architectural cultures.

These examples are: "A walking city" (Archigram); "Solohouse" (Lebbeus Woods); the Monument to the Third International (Vladimir Tatlin); and the hydroelectric plant of Città Nuova (Sant'Elia).

In all four cases, the author's intention was not only to forge a utopian reality but also to trigger a reflection on the social reality of their own time.

This paper focuses on the study, conceptual interpretation, modeling and digital fabrication of these utopias, with the purpose of highlighting the importance of digital recovery of urban and

architectural heritage of the past, and creating, an analysis tool from the present through new technologies.

## 2. Methodology

The first stage of this work is the study of each building in its historiographical baggage, in order to internalize aspects inherent to the origin and gestation of each project in its context of creation. To that end, was required the assistance of different national academic references in the areas of history and theory of architecture, who provided a documented and rigorous view as a key for contextual understanding

Starting from this framework, we proceeded to the formal approach of different projects, contrasting graphics, preliminary studies and other specific sources for each case, to find the laws of generation of the latent form in the proposal. Thus, the digital modeling in CAD format was obtained for each project to be materialized by any criteria (addition, folding serial carved by faces, etc.). For each digital materialization was chosen the most appropriate morphologic strategy.

The full range of digital fabrication possibilities, laser cutting of MDF, acrylic, PET and corrugated cardboard of various thicknesses was applied. This decision was made to give some visual homogeneity to the product, make affordability of inputs manufacturing and test various assembly techniques for each case. The main feature of this technique is that it usually leaves a burnt edge, revealing its source and highlighting the presence of the digital method used.

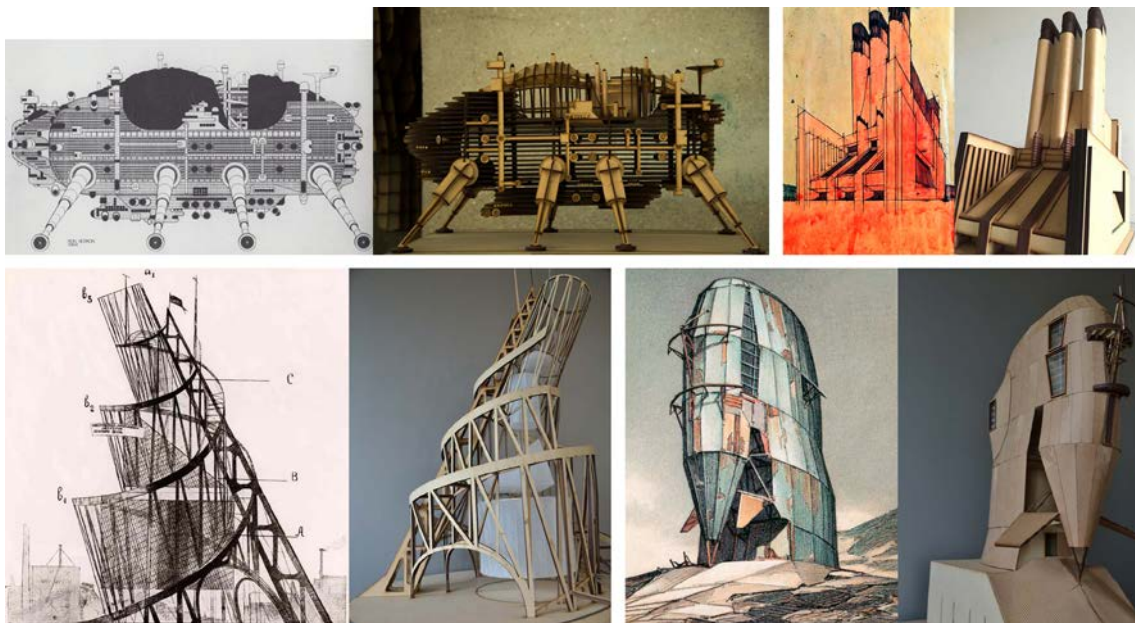

Figure 1. Original drawings and built models.

Depending on the example represented, we chose linear pieces which would prove the structural logic of the set (as is the case with the work of Tatlin), leading to massive conceptualizations (Sant'Elia case), or sheet-like layers based on serial (Archigram). In the work of Lebbeus Woods mixed media was chosen, partly using, folded, and recorded structural resources.

## Utopia. Digital fabrication of non-built architectures

The laser cutter can cut only materials of constant thickness, since the laser focus and the necessary heat for cutting is obtained within a very small margin between the nozzle and the material surface distance. This limitation led to the devising of techniques that allow curving surfaces once cut. Linear prints were made with the depth of average thickness, parallel to the directrix of curvature, in order to achieve the necessary shape, so raising the sense of curvature.

In all cases, it was avoided to fall into merely instrumental criteria in the use of new techniques to harness the enormous potential that these provide. Thus, traditional methods of generating the way through faces is obviated, which would become the cutting machine in a simple privileged cutter.

| Project                      | Author            | Scale  | Dimensions    | Type of fabrication | Qty of pieces | Material     |                 | Model |      | Fabrication |      | Time of assembling |      |
|------------------------------|-------------------|--------|---------------|---------------------|---------------|--------------|-----------------|-------|------|-------------|------|--------------------|------|
|                              |                   |        |               |                     |               | Type         | Qty             | Hours | Days | Hours       | Days | Hours              | Days |
| A walking city               | Archigram         | 1:666  | 60 x 35 x 32  | Laser cut           | 150           | MDF 3mm      | 5 pieces 120x90 | -     | 7    | -           | 2    | -                  | 4    |
|                              |                   | 1:2500 | 16 x 13 x 10  | 3D Print            | 19            | ABS          | 120 g           |       | 1    | 10          | -    | 2                  |      |
| Hydroelectrical Central      | Antonio Sant'Elia | 1:200  | 57 x 27 x 56  | Laser cut           | 900           | MDF 3mm      | 5 pieces 120x90 | 30    | -    | -           | 2    | -                  | 7    |
| Third International Memorial | Vladimir Tatlin   | 1:350  | 90 x 90 x 115 | Laser cut           | 150           | MDF 3mm      | 6 pieces 120x90 | -     | 7    | -           | 2    | -                  | 10   |
|                              |                   |        |               |                     | 5             | MDF 6mm      | 2 pieces 120x90 |       |      |             |      |                    |      |
|                              |                   |        |               |                     | 10            | Acrílico 3mm | 1 piece 120x90  |       |      |             |      |                    |      |
| Soloohouse                   | Lebbeus Woods     | 1:40   | 65 x 30 x 72  | Laser cut           | 44            | MDF 3mm      | 6 pieces 120x90 | -     | 4    | -           | 4    | -                  | 7    |
|                              |                   |        |               |                     | 14            | Cartón       | 2 pieces 120x90 |       |      |             |      |                    |      |
|                              |                   |        |               |                     | 6             | Acrílico 3mm | 1 piece 90x60   |       |      |             |      |                    |      |

Table 1. Timesheet.

### 3. Results

The product of this work resulted in several salient levels of diffusion in national universities, but also internationally.

The exhibition "utopia; the unbuilt "was first shown during the XVIII edition of the annual congress of the Iberoamerican Society of Digital Graphics (SIGRADI) at the Faculty of Architecture of the University of the Republic in Montevideo during the month of November 2014.

After that, it was the subject of a new exhibition at the Contemporary Art Space (EAC) of Montevideo, and alongside one of its pieces (Archigram), participated in the exhibition "Homo Faber" carried forward during the CAADFUTURES 2015 congress in the University of Campinas, Sao Paulo University, and the Mackenzie Presbyterian University in São Paulo, Brazil. The same piece was selected to participate in a new exhibition of digital manufacturing in Latin America during the last edition of the annual congress of SIGRADI at the Federal University of Santa Catarina, in November 2015.



Figure 2. Exhibition during SIGRADI and CAAD Futures.

Also, as a general catalog for the exhibition, the organization of SIGRADI 2014 financed the publication of a book called "FAB/01. Digital manufacturing of unbuilt architecture", which gathers not only the technical aspects of research, modeling and digital manufacturing processes, but incorporates historical articles and reviews of each project by the experts consulted at the beginning of this research.



## Uthopia. Digital fabrication of non-built architectures



Figure 3. Book cover.

There is also a website ([www.fab01-uthopia.com](http://www.fab01-uthopia.com)) that displays all work results and also gives access to the digital version of the book mentioned above.

The exhibition aroused great interest from the academic group and general public, emphasizing the novelty of the proposal and the educational interest in understanding the intrinsic value of the works studied in their social contexts and historical dimensions.

### 4. Discussion

The application of new media and cutting-edge technological tools to rescue architectural heritage is definitely not something new or emerging. However, as formal redefinition involves digital three-dimensional modeling and enactment also digitally, partially applying to utopian ideas put on paper, it does present certain values that are worth mentioning.

On one side, the value of interpretation, which is a sort of “digital anastylosis” proposes the challenge of the apprehension of the model starting from the supposition of a missing dimension and taking as an input the drawings and ideas of its creator. On the other side, the formal constitution and material ideas that had the status of emblem and went down in history as great utopias that triggered the thinking of architects and planners to new horizons.

In both cases, it is expected that with the help of new technologies, teaching and training objectives for the full understanding of each project accompanies the contribution to the general knowledge that the appreciation of heritage and current cultural stage requires and demands.

### Acknowledgements

To Professors Roberto Langwagen, Juan Grompone, Alejandro Folga, Jorge Nudelman, Mary Méndez, Laura Alemán, Marcel Blanchard, Laura Fernández, María Magdalena Peña,



Pablo Canén Suárez, Cecilia Hernández Aguirre, Carlos Pantaleón, Salvador Schelotto and all colleagues, students and friends who helped to accomplish this work.

## References

- Bahn, P. And Renfrew, C.: 2012, *Arqueología: teorías, métodos y prácticas*. Akal.
- Gershenfeld, N.: 2007. *Fab: the coming revolution on your desktop. From personal computers to personal fabrication*. Basic Books.
- Mitchell, J.: 2003. *The cyborg itself and the networked city*. MIT.
- Moreno Sperling, D. And Herrera P.: 2015. *Homo Faber. Digital fabrication in Latin America*. UFSP.
- More, T.: 1999. *Utopia*. S.L.U. Espasa Libros.

# The coherence between smart objects and Artificial Intelligence in architectural digital design process

**Georgios Vlachodimos**

*Msc Architect, PhD*

*Aristotle University of Thessaloniki,*

*Greece*

*g.vlachodimos@yahoo.com*

**Abstract:** In the present paper, will be discussed the primary motivations for the usage of parametric data in computational collaborative design for the final goal of Artificial Intelligence. The main section of this paper, will investigate the concept of design process and how it can behave the architectural programs at the smart objects in general. The use of this type of design ideally should shorten the time span spent on detailed modelling of built artifacts. In the final section will be described the effort that is needed to ensure that the parameters - algorithms are carried forward into the smart objects and buildings. It will also briefly describe the fundamental design process of using data in a computational design environment at the present time. Finally, through the discussion, the paper shows the difference between the smart of automation elements and the “eureka moment” of creativity in Artificial Intelligence.

**Keywords:** *Parametric Design, Design process, Algorithms, Computational, Smart buildings*

## 1. Introduction

The power of the human brain to perceive and understand everything of info around us is limited regarding the data that computer can calculate [1]. The way things are perceived varies and hence, the degree of complexity is different for everyone. Decoding this complexity either extends the boundaries of human perception or simplifies the complexity of human understanding. The computers systems are hard to understand or decode this “perception” by themselves.

Nowadays, digital design systems in architectural applications contain a variety of flexible objects which everyone can manipulate and change the constraints and parametric variations of these. The reconsideration of all types of topology surfaces and the parameterization of digital design has contributed to the exploration of new geometrical possibilities. Within this emerging context, the associative models are become powerful tools having the ability to change the properties numerically without the need to redraw them. In such a context, the relationships between objects are explicitly described in a real world and can be easily transformed and manipulated by activating the attributes which are linked to a database but without the meaning of Artificial Intelligence.

## 2. The Definition of 'Intelligence'

Before we can proceed with the theme of this paper it is necessary to briefly discuss the concept of intelligence and the sense in which this concept is applied by the author. There are those that have advanced strong arguments that intelligence is the province of living creatures and that machines, such as electronic computers, do not and will never display any truly intelligent capabilities (Dreyfus 1979, 1986 and 1997, Lucas 1961, Searle 1980 and 1992). In most cases these arguments are based on the premise that intelligent behaviour is closely associated with the human body and mind, and that the powerful notions of common sense and intuition are essential ingredients of intelligence. It is not the purpose of this paper to attempt to counter these arguments or even take sides in this debate.

Dreyfus's conclusion is that computer and human intellect are different at a physical level. Where the computer uses digital means, the brain uses both digital (discrete) and analogue (continuous) forms of information relaying and processing; thus AI is not achievable purely through digital means (Dreyfus, 1992).

In a future development of an advanced system, there is a hope to achieve these modifications that will be driven by the artificial intelligent. Finally, Negroponte, in his book 'Soft Architecture Machines' (1975) recognized that there was a need for the architect to engage with the computer in a way that went beyond simply regarding it as a tool.

## 3. Computational thinking

'Computational thinking' implies learning to think like a computer, but thinking is a human concept that computers are not actually capable of. What they are capable of, and extremely capable compared to humans, is calculating. Computers can calculate simple mathematical problems at a speed almost unimaginable to those of us who have to think hard to do maths. Unfortunately simple maths at unimaginable speeds is fundamentally all they can do. Every complex problem we want them to solve, it has to be simplified and expressed as a basic mathematical calculation. 'Computational thinking' is the understanding of how to construct problems so they can eventually be expressed in binary mathematics. However, before a problem can be tackled, the problem itself and the ways in which it could be solved need to be understood.

There are four key techniques (cornerstones) to computational thinking: 1. Decomposition - breaking down a complex problem or system into smaller, more manageable parts. 2. Pattern recognition – looking for similarities among and within problems. 3. Abstraction – focusing on the important information only, ignoring irrelevant detail. 4. Algorithms - developing a step-by-step solution to the problem, or the rules to follow to solve the problem

A complex problem is one that, at first glance, we don't know how to solve easily. Computational thinking involves taking that complex problem and breaking it down into a series of small, more manageable problems (decomposition). Each of these smaller problems can then be looked at individually, considering how similar problems have been solved previously (pattern recognition) and focusing only on the important details, while ignoring irrelevant information

## The coherence between smart objects and Artificial Intelligence in architectural digital design process

(abstraction). Next, simple steps or rules to solve each of the smaller problems can be designed (algorithms).

### 4. Parametric Design and Algorithms

Parametric design, in recent years has developed a motto (Parametricism) as it's being used mainly to design shapes, structures that respond to the general concept, to their environment, climatic issues and contextual features. While it can operate as a powerful tool in contributing to the realm of the design process, it is only appreciated as physical applied parametric modeling techniques.

It should also be noted that, from an elementary point of view, there is not a clear boundary between what can be called parametric design and what is currently called computer aided drafting or modelling. In these cases, forms are created by combining basic entities that are inserted in the model after a basic template, which includes their "proper parameters", is filled. Besides this, we can also define "families" (Revit), "cells" (Microstation) "part" or "components" (Catia, Solidworks) that combine and keep together with different overall values these primitive forms. There are also, in current CAD systems, tools that allow us to make some modifications a posteriori on these primitive entities.

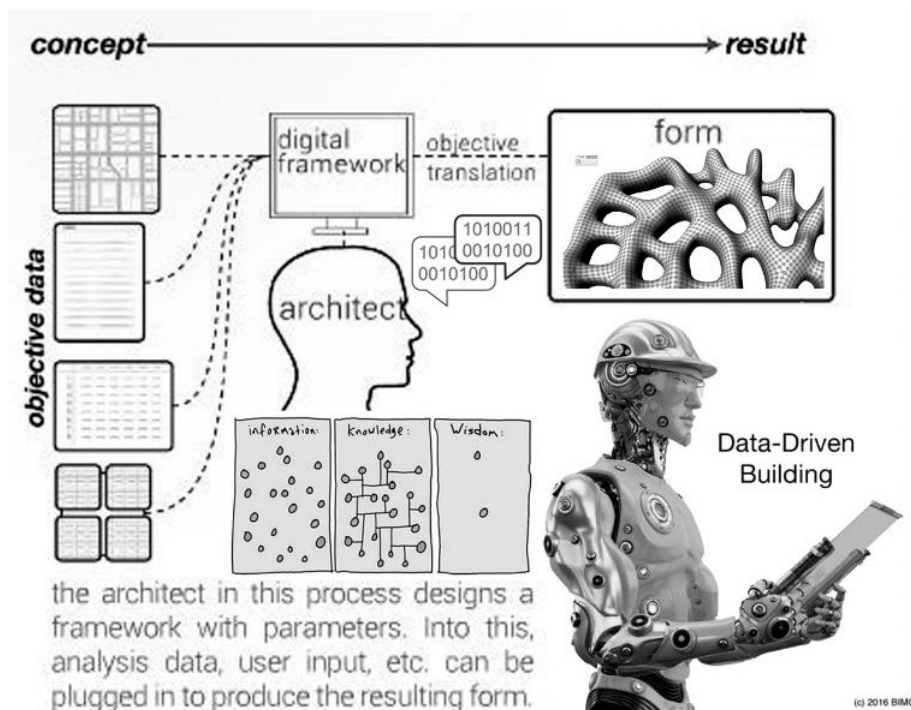

Figure 1. Architect design framework that generates form.

When one writes a computer program, one is generally implementing a method of solving a problem which has been previously devised.. In any case, it is the method, not the computer program itself, which must be studied to learn how the problem is being attacked. The term algorithm is universally used in computer science to describe problem-solving methods suitable

for implementation as computer programs. Algorithms are the “stuff” of computer science: they are central objects of study in many, if not most, areas of the field.

The architects can now think and draw with codes, or by combining the code to the project. In the new digital environment, design refers to the determinants of the components and the syntax in code relations, which specifies clearly. This is a common process in digital computational design with codes, algorithms and parametric design in general. This is very promising for a good base of the development of Artificial Intelligence. Conclusively, the algorithms are the main communication with the computers and with these we can achieve the management of the complexity of the Intelligence in general.

## **5. Knowledge/data, the key for smart objects**

An object, from a computer science point of view, is an independent procedure that contains both the instructions and data to perform some task, and the programming code necessary to handle various messages that it may receive (Morris 1999).

Constraints and parametric variation, which BIM – CAD industry is built around, have been active areas of investigation in computer- aided architectural design for over fifteen years. Parametric design relies on the ability to change an object’s properties numerically without the need to redraw it. The CAD system takes care of the redrawing part of the parametric object, but the parameters themselves must be previously assigned to the object.

The necessary information for the set of parameters of an object makes up architectural knowledge. The object will not be useful without the knowledge used to construct it. But the problem is that the object is as good as the knowledge behind it. Adding more information to that object becomes a question because the way the code is written may make it hard for an average user to manipulate. The knowledge required to support an object which should have a certain structure to it, as the concept of the smartness will depend on how complete and how smartly the embedded information reacts to other objects. Different levels of knowledge need to be included.

## **6. The concept of Intelligent and Smart buildings**

The case of intelligent building presents the strongest level of communication among a building’s systems and the objects that apart the all building. The term “building systems” refers to all systems that operate a building like HVAC, mechanical, structural, access control, safety and security, building management, lighting, maintenance, local networking, voice and data communication and energy management. In general, buildings are technology, accommodate technology, and use the technology. Buildings as objects become intelligent in the moment of gaining computer ability and data. Integration gives these systems the ability to communicate and transfer information. Communication among these systems [2] allows output decisions to happen without conflict.

The intelligent building should have the same operation concept that has the ability to be adjusted according the different needs. Scientists have defined “intelligent building” in terms of a building having the latest technology, so they consider a building to be intelligent when it has the

## **The coherence between smart objects and Artificial Intelligence in architectural digital design process**

latest building systems. For example, the International Symposium, 1985, in Toronto, states that “intelligent building combines innovations, technological or not, with skillful management, to maximize return on investment.” [3].

In general, an intelligent building is therefore a ‘big object’ that has the ability to respond on time according to processed information that is measured and received from exterior and interior environments by multi-input information detectors and sources to achieve users’ needs and with the ability to learn. Intelligent building should have nervous system consisting of embedded sensors and actuators that control most real time information [4].

‘The artificial neural networks, it’s about the real thing. There is no difference between the human and the architectural, as there was when we are speaking of artificial neural networks. The brain clearly has certain determining form, but one that changes over time. We can see that some of the ways in which he has been thinking about form and structure are simply epoch making in relation to our work, and can provide us with a language which, on the one hand is ground breaking and, on the other, can assist us in understanding how these brain processes unfold. And it is incredible that his computer models of these processes can help formulate a new language.’ (Source: Novac, 2005)

Operation process is clear also in (DEGW 1998) definition that says “intelligent building is more responsive to user needs and has the ability to adapt to new technology or changes in the organizational structures.” [5]. Integrating learning ability that includes the adaptability mentioned by DEGW definition of intelligent systems should make systems able to learn from their experiences with similar cases reaching to optimum solution. In addition to the learning ability, information transferred between systems should be processed and analysed in Building Control System (BCS) that works as building brain.

By taking into account all the above, the management of parameters, attributes, algorithms and all this big data, it is a different thing until to achieve the level of Artificial Intelligence. Conclusively, in a future development of an advanced system, there is a hope to achieve these modifications that will be driven by the artificial intelligence.

## **7. Conclusion**

This paper - research is mainly going to scrutinize the design process by means of inspecting digital smart tools and to create a framework based on technological tools for contemporary architecture design as a system in order to bridge theoretical context and practical achievements by means of investigating in existing gap and develop a holistic framework for parametric design procedure of AI field.

The investigation into the concept of AI computability domain and its importance for digital design in architecture shows that the computer is not a neutral tool, but rather is actively shaping the way designers are approaching the question of design in general.

However, we have to be very careful that we balance the requirements of architecture in general with the in-depth investigation of form that is possible with computers. So those instead of driving the technology and not to driving us, with other words, to use the computer like a tool.

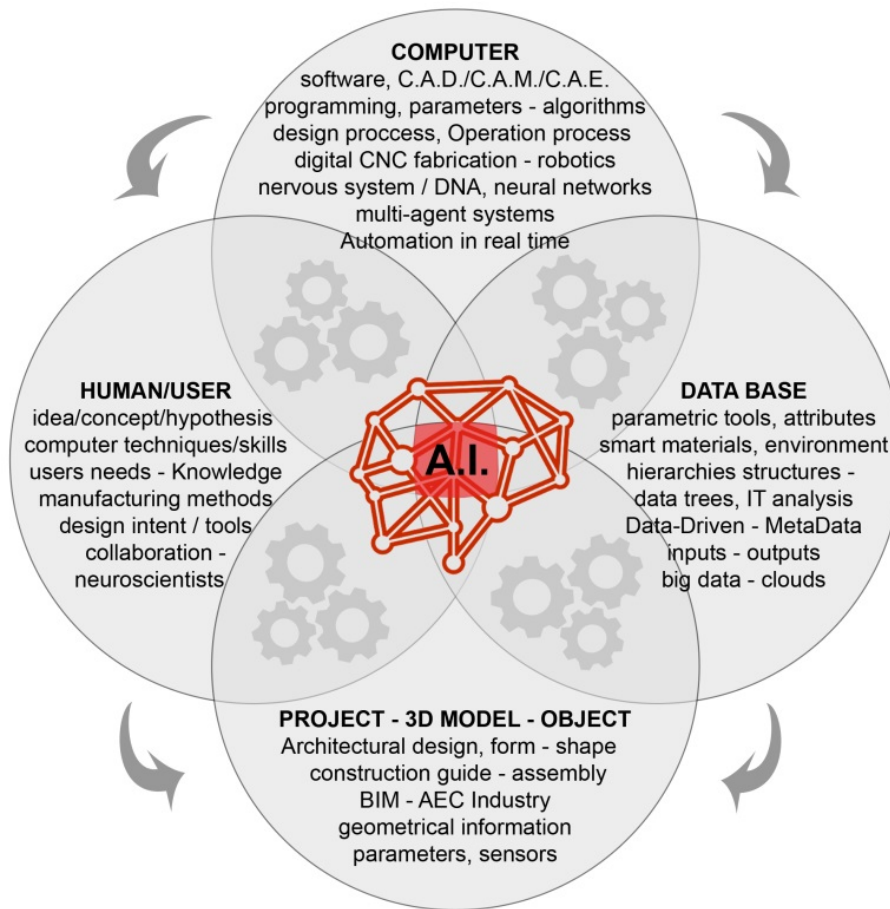

Figure 2. Development of an advanced system, that will be driven by the artificial intelligence.

This point of view of the digital design in architecture opens up a new line of theoretical discourse in architecture that differs from the traditional relationship between architecture and design. The proposal is to combine technologies for creating Artificial Intelligence in a real time environment.

Finally, the development, which will result from this research, shall help to be set up industry AEC standards in the future, and to decide the best suited solution by AI. Owing to the continuous, evolving technological progress that intelligent buildings - objects are a part of, this subject needs further exploration by many domains of science.

## Endnotes

1. The basic computer can do floating point arithmetic 33 billion times faster than we can, but that doesn't mean it's intelligent in the way a human is.

2. Each system in the intelligent building should have a means of collecting input information. Systems can obtain information in four different ways: sensors (real time), internal



## **The coherence between smart objects and Artificial Intelligence in architectural digital design process**

backup and restored information, manually entered information (programming - processing) by users (data, needs), and by being connected online (Internet).

3. EIBG (European Intelligent Building Group) definition says "the intelligent building is the one that maximizes the efficiency of its occupants and allows effective management of resource with minimum life costs."

4. According to M. Novak, nanotechnology is about to change architecture completely. Buildings adjust by themselves. A neuroarchitecture replacing bricks and mortar with intelligent, plastic nanomaterials, keeping the central nervous system of the building informed on inner and outer influences, in precisely the same way that this occurs in the human body

5. DEGW founded in 1974 by F. Duffy, P. Eley, L. Giffone and J. Worthington, the firm became internationally known for its design of "intelligent" buildings, and its blend of thorough analysis, extensive consultation, and strategies for ensuring the flexible utilization of a building.

### **Acknowledgements**

There is no intention by the author to suggest that computer intelligence is equal or even similar to human intelligence, but rather that computer intelligence and human intelligence may be applied in parallel to complement each other. Furthermore, a strong case can be made in support of the view that there is an urgent need for intelligent computer capabilities due to the mounting expectations of accuracy, quality and timeliness in a globally connected environment of rapidly increasing complexity.

The author would like to express his gratitude to 'In-Play 2016 International Conference'. It's organized by the Institute University of Lisbon (ISCTE-IUL) and La Sapienza Università de Roma.

### **References**

Atkin, B.: 1988, Progress towards Intelligent Building. in Atkin, B. (ed.) Intelligent Buildings Applications of IT and Building Automation to High Technology Construction Projects. London: Unicom Seminars limited.

Culshaw, B.: 1996, Smart structures and materials, Artech House, Norwood, MA.

DEGW.: F. Duffy, C.Cave, J.Worthington.: 1998, Design for Change: The Architecture of DEGW: The Architecture of Ideas Birkhäuser Basel.

Dreyfus H.:1979, 'What Computers Can't Do: The Limits of Artificial Intelligence'; Harper and Rowe, New York.

Dreyfus H. and S. Dreyfus.: 1986, 'Mind Over Machine: The Power of Human Intuitive Expertise in the Era of the Computer'; Free Press, New York.

Dreyfus H.:1997, 'What Computers Still Can't Do: A Critique of Artificial Reason'; MIT Press, Cambridge, Massachusetts.

Eggink, D., M.D. Gross, and E. Do.: 2001, Smart objects: Constraints and behaviors in a 3D design environment. Architectural information management: 19th eCAADe conference proceedings, Hannu Penttil, 460-65, Finland, Helsinki University of Technology (HUT), 29-31 August 2001.

Kolarevic, B., G. Schmitt, U. Hirschberg, D. Kurmann, B. Johnson.: 2000, An Experiment in Design Collaboration, Automation in Construction 9, Elsevier Science B. 73-81.

## Georgios Vlachodimos

Kymmell, W.: 2008, Building Information Modeling: Planning and Managing Projects with 4D.

Ibrahim M., Krawczyk R.: 2003, The Level of Knowledge of CAD Objects within the Building Information Model. Connecting >> Crossroads of Digital Discourse Proceedings of the 2003 Annual Conference of the Association for CAD In Architecture. Indianapolis (Indiana) 24-27 October 2003, 173-177.

Markussen T. & Birch T., aka bleep.dk. Minding Houses. intelligent Agent 5.2 < <http://www.artbrain.org/events.html> > (accessed 3 May 2016).

Novac M.: 2005, Architecture and Architectonics. First Neuro-Aesthetics conference. Goldsmiths University, London UK, May 2005.

Terzidis K.:2006, Algorithmic Architecture, Architectural Press, Routledge.

# Frei Otto's Contribution Legacy to Parametric Design and Material Computation

**Alexandros Peteinarelis**

Technical University of Crete

Chania, Greece

ng5ten@yahoo.com

**Abstract:** This paper investigates Frei Otto's work and suggests that it has impacted today's parametric design methodology and computational form finding tools. It attempts to trace elements of his work and writings, in relevant bibliography and the Stuttgart's ICD (Institute for Computational Design) research [computational design] agenda.

**Keywords:** *Frei Otto; Parametric; Form-Finding; Material-Computation.*

## 1. Introduction

Today's computational design tools offer a vast variety of possibilities, which can be utilized during the design and the construction phase of a project. These applications have already impacted both academia and the professional field of architecture. New architectural styles have been introduced, like Patrick Schumacher's Parametricism in "Parametricism as Style" (2008). This change has gradually emerged through a series of technological shifts that happened during the second half of the 20th century leading to the current digital culture. In this context and along this direction this paper investigates Otto's work and suggests, that it has impacted today's parametric design methodology and computational design tools. It attempts to trace elements of his work and writings, in relevant to computational design bibliography and the Stuttgart's ICD research agenda. This research starts from the presentation of Frei Otto's design principles and experimental form finding methodology, as these have been documented in the IL publications (Institute for lightweight structures). Otto emphasized the benefits of the interdisciplinary collaboration of various scientific fields. This collaboration could be argued, that is a substantial need for today's architectural practice, when as Antoine Picon (2003) argues "Computer-based design often appears to neglect the material dimension of architecture, its intimate relation with properties like weight, thrust and resistance" and constitutes, amongst others, one of the main research aims of the ICD. But before proceeding to material computation, parametric design definitions are presented. These are documented in relevant bibliography, but the main source is Daniel Davis's (2013) PhD thesis. Thus, the criteria are established, that associate Otto's work and research with parametric design and material computation.

## 2. Principles and research agenda

Otto stood against monumental architecture, the impression of permanence through monumentality and mass that was established by the Official National Socialist architecture. Otto found in Matthew Nowicki's suspended cable net and therefore in lightweight structures, the perfect anti paradigm against the monumental and symbolic trend. Nerdinger (2005, pp. 13) reports, that Otto was also questioning modernism. He thought that "Modern architecture is dead" and that "The Monument is back". So in 1957 he starts an intensive research exploring architectural form finding. He promotes interdisciplinarity, aiming at the collaborative fusion of the architect, the structural engineer, the biologist etc. "Frei Otto has worked like no other 20th century architect on investigating 'Gestaltwerdung' ... and on developing a new form of light and natural, adaptable and changeable building from the understanding that flows from research." (Nerdinger, 2005). Thus, it has been established<sup>1</sup> the notion of collaborative research. In 1961 Otto founded the Biology and Building research Group, where he explored natural formations, to understand the processes that take place, when nature "builds" forms. Self organization and the material economy would be the design principles, which could answer to his rejection of individual self-representation in designing and building<sup>2</sup>.

### **3. Methodology and work**

Otto's preferred working medium is the physical model. He uses experimental models that go far beyond traditional methods of calculating stresses developing unconventional optimization processes to achieve structural efficiency and extreme lightness. He develops form finding techniques, that work with constraints and parameters, which define in equilibrium the final form. These form a dialogue from mock up model to full scale construction and lead to the understanding of material's behavior. His method formed material systems, and like Spuybroek (2002, pp. 132) argues analog computers. "Each of these machines was devised so that, through numerous interactions among its elements over a certain time span, the machine would restructure, or as Otto says, "find form"... Most of Otto's analog machines consist of materials that process forces by transformation, which is a special form of analog computing". But Otto took a step forward pioneering computer based procedures that have been used for the Olympic Games tent in Munich (1972) and other projects. Physical models have been implemented by other architects and engineers. They were heavily used in structural engineering for the structural optimization and behavior simulation of a given structure. Gaudi, used the hanging chain models, others like Robert Maillart, Piere Luigi Nervi, Eduardo Torojja and Heinz Isler were mainly focusing on structural integrity.

### **4. Parametric design definitions**

In order to associate Otto's work with parametric design, it is essential to examine its various definitions.

#### **4.1 Design change, entities relations (design/model behavior)**

## Frei Otto's Contribution - Legacy To Parametric Design And Material Computation

In most cases, when parametric design is described, the ability of the design's representation to "change" makes up the main qualitative characteristic of the interpretation. Yessios (2003, pp. 263): "Initially, a parametric definition was simply a mathematical formula that required values to be substituted for a few parameters in order to generate variations from within a family of entities. Today it is used to imply that the entity once generated can easily be changed". Woodbury (2010, pp. 11): "...parametric modelling introduces fundamental change: 'marks', that is, parts of the design, relate and change together in a coordinated way".

### 4.2 All design is parametric (parameter in design/model)

Another approach, that is widely documented, is holistic and suggests that design was always parametric. Aish and Woodbury (2005, pp. 152): "Parametric modelling is not new: building components have been adapted to context for centuries". Gerber (2007 pp. 54): "It must be stated that architectural design is inherently a 'parametric' process and that the architect has always operated in a 'parametric fashion".

### 4.3 Mathematical (based on the mathematical term "parametric")

The last approach presented is defined by the etymology of the term parametric, which originates from the field of mathematics. Davis (2013, pp. 31): "...a parametric model is unique, not because it has parameters (all design, by definition, has parameters), not because it changes (other design representations change), not because it is a tool or a style of architecture, a parametric model is unique not for what it does but rather for how it was created. A parametric model is created by a designer explicitly stating how outcomes derive from a set of parameters... As such, I define a parametric model as many mathematicians would: as a set of equations that express a geometric model as **explicit** functions of a number of parameters".

## 5. Frei Otto's contribution

After these selected definitions it can be argued, that parametric design is an ambiguous topic, that is under recurring and ongoing debate. Many have distanced themselves from the term, in order to avoid the ambiguity and use computational design instead, which forms a larger notion that contains parametric, algorithmic etc design. All these are part of the digital culture, which forms the platform for debate and further investigation, whether design is confronted as a process or as the final outcome of the process. This is where the connection with Otto's work is established. With the following description of Otto's work and research, it is attempted to trace elements that can be found amongst the various parametric definitions.

When analyzing Otto's physical models, it can be argued, that they aren't just representational models, but they are analog computers. There is a direct connection of the representation of the form in Cartesian coordinates with the surrounding environment, that either embeds forces (wool threads emerged into water), or is the context where forces will be applied to the active form subject (hanging chain models). Like Lynn (1999, pp. 10) suggests "Form can be shaped by the collaboration between an envelope and the active context in which it is situated".

One particular case of applied force form finding is the building Multihalle in Manheim (1975). This structure is a gridshell that derives its strength from its double curvature. Otto worked with hanging chain models that had rigid perimeter, which defined the boundary of the structure and supported the dead and self weight of the model. "A hanging chain has at least four parameters: its length, its weight, and the two points it is attached to. Left to hang under the force of gravity, the chain makes a curved shape. This curve is an explicit function of the chain's parameters with the added property that when inverted the curve stands in pure compression. While there is no computer, the hanging chain is a parametric model due to the presence of parameters that control a shape derived from an explicit function (in this case calculated by gravity)" (Davis, 2013, pp. 22).

The ability of these models to change creates variability. A collection of multitudes, that expresses the initial conditions and instruction sets. This resembles the population thinking found in biology, when classifying taxonomies. For the Multihalle Otto created a series of physical models with varying boundaries, different heights and configurations of the weights. These were catalogued in the IL 13 publication in 1978, along with the process of form finding and construction description. This variation is a feature found in parametric design. When dealing with multitudes Manuel De Landa (2002, pp. 9) argues, that the application of evolutionary algorithms, as a design aid becomes useless if the final form(s) is foreseeable. Genetic algorithms are to be considered useful when their outcomes embed the notion of surprise and the search space [variation spectrum] they cover is large enough to produce unpredictable results. Are Otto's models analog evolutionary algorithms solvers? By computational means they are not. Still, in optimization cases, the fitness function could be the intention to have the lightest and strongest form possible and the genes could be the in between states of the model before equilibrium. Even if this analogy is proved with further research to be weak, Otto's physical models do offer a great number of unforeseeable outcomes. These would need a large set of analog descriptions, i.e. architectural plans, sections etc, in order to be examined and evaluated. Even if setting aside all the necessary manual structural calculations, the documentation itself would prove a long and tedious procedure, in order to fully describe the various outcomes. Otto utilizes many cameras to record frames of the iterations in each model. This procedure initiates animation techniques during form finding and describe the shift from inanimate to animate architectural synthesis. The ability of these models to change, to produce according to parameters various results, entities and relations, sum up the main advantages of parametric design and define the development of parametric and simulation software.

Another quality, which is of great importance in simulation and parametric software, is the real time processing. This is integral, so that the designer can grasp and observe the action taken and its effect. Otto's real time analog computers start off from a simple in equilibrium state, containing some information, i.e. the wool threads anchored in pins formations. This state is disturbed, by immersing the wool threads into the tank filled with water. New information is introduced, the effect of water to the wool threads, and in real time these drive the system into a new equilibrium, the final form (Spuybroek, 2002, pp. 139).

## **Frei Otto's Contribution - Legacy To Parametric Design And Material Computation**

Otto introduced another set of parameters during the form finding process, which are the material's properties. He used soap films in order to understand and design tensile structures and membranes. Soap, given a specific boundary, has the tendency to form a film surface, which is always trying to minimize its area and the tension among its molecules. Here the shape emerges from the embedded properties of the material and the self organization of its molecules. This method allowed Otto to create a great number of different and efficient tensile forms. Thus a new relationship between the designer and the outcome is established. The model is autonomous, since the materials properties form an internal mechanism. This mechanism is not related to the designer's intentions, though the interactivity is maintained, so when a parameter is altered the result is unexpected and only observed through the model. That is another characteristic of parametric design, where the parametric model is expected to change, with an adequate immediacy, creating an outcome, which is not necessarily deterministically decided.

### **6. Material computation**

Introducing material properties during the form finding opens a vast space for research. They are no longer treated as constraints, but are the source of the design process. The need of the form to comply with the construction material is reevaluated and using computational terms, material can act as software. With this antistrophe at current research, a return to analog experimental control, as a validation tool of the virtual simulations, is signaled. The ICD in Stuttgart has extensively researched this topic. They implement computational tools and fabrication techniques that are evaluated, through the construction of a small scale structure. They work mostly with wood, but also with other materials (fibers, textiles etc). Wood expresses, in time, dimensional variation according to the level of humidity present inside itself and in the environment it is exposed to. It is also an anisotropic material, so its strength, bending resistance and elasticity depend on the structure, flow and direction of its grain. These properties are counteracted by the wood industry, since they are considered disadvantageous in a wooden structure. But what if these properties are examined within a different scope, as a system, a container of information? Achim Menges (2012 pp. 16) notes that a novel convergence of computation and materialization is about to arise. There lies the chance to reduce the conceptual gap between computational design and the physical realization of architecture.

#### **6.1 ICD/ITKE research Pavilion 2010**

The 2010 research Pavilion is a structure where the elastic bending behavior of wood is the generative parameter in the computational design process. In this research both virtual and physical models were utilized to analyze and log wood's elastic range and bending values. The result is a mono-material structure, where skin and structural skeleton form an active system without the need of separate structural elements. The close collaboration with ITKE creates interplay of architecture and structural engineering. FEM simulations compute and verify the results between virtual and physical models. According to Menges (2012, pp. 50) "The project demonstrates how focusing the computational design process on material behavior rather than



geometric shape allows for unfolding performative capacity and material resourcefulness while at the same time expanding the design space towards hitherto unexplored architectural possibilities."

## 6.2 ICD/ITKE research Pavilion 2011

The following year's research pavilion investigated the possible applications of biological principles. The aim was to design and construct a structure which is light and structurally efficient, made completely of extremely thin 6.5mm plywood elements. During the analysis of sea urchins plate skeletons, the sand dollar, a subspecies of the Echinoidea family, was chosen to be further investigated. Like in the 2010 pavilion, form finding and structural design are interlinked through FEM simulations. Experimental glued and bolted joints were tested, virtually and physically. The result was plywood panels, that were later assembled into shell entities, to complete the structure.

## 7. Conclusion

Frei Otto established one of the main stepping stones for the transition of architectural thought from the mechanical perception, to a systematic, interdisciplinary design research agenda. The topics and methods he was occupied with, are employed by current researchers and the developers of computational tools. These are natural formations, material properties, force driven design, extreme lightness and the use of analog and virtual models to verify the results. Taking advantage of the capabilities offered by fabrication tools and computational software the legacy of Otto's research is being further investigated, broadened and improved. A crucial question for him was how to link structures, along with their quality, to the people that experience them. Can issues like complex human behavior, culture, history, collective memory, human desire and politics be a part of parametric and computational design, as parameters? One could argue that often most of the above seem to be left outside the scheme. The convenience that digital tools offer, sometimes leads to architectural design, that is too much preoccupied with what can be designed, rather than what should be designed. This devotion and idolization to computation takes away a lot, of what can possibly be achieved. There is no lack of digital tools or computational methodologies, which keep pushing forward, but as A. Picon (2003, pp. 111) argues " The real problem of today's architectural scene is in my opinion not so much its possible dematerialization than its lack of clearly defined political and social priorities."

## Endnotes

1. Interdisciplinarity can be traced back to Greek philosophy, drama and history. It was widespread applied in the second half of the 20th century. Until then scientists were bounded in their departmental boundaries.

2. Interestingly David Rutten (2015), developer of algorithmic editor grasshopper3d, replies to the question: "What is the difference between algorithmic and parametric architecture?" the

## **Frei Otto's Contribution - Legacy To Parametric Design And Material Computation**

following: Algorithmic: (also 'computational'). It's the same as parametric, except you don't just pick the parameters out of the blue to suit your sense of aesthetics. Instead, you use computation and algorithms to figure out which parameter values are optimal for your goals. Algorithmic is what you get if you abandon your ego and inject some rationality into Parametric.

### **Acknowledgements**

This research has been conducted under the supervision of Socrates Yiannoudes [Lecturer, TUC, School of Architecture], who provided invaluable bibliographic resources. I would also like to thank Nikos Patsavos [Adjunct Lecturer, TUC, School of Architecture] for his comments and input.

### **References**

- Aish, R. and Woodbury R.: 2005, Multi-level Interaction in Parametric Design, in Smart Graphics: 5th International Symposium.
- Davis, D.: 2013, Modelled on Software Engineering: Flexible Parametric Models in the Practice of Architecture, PhD Dissertation, RMIT University.
- DeLanda, M.:2002, Deleuze and the Use of the Genetic Algorithm in Architecture, in AD: Contemporary Techniques in Architecture, Volume 72, No 1, Wiley
- Gerber, D.: 2007, Parametric Practices: Models for Design Exploration in Architecture. Ph.D. Dissertation, Harvard University.
- Lynn, G.: 1999, Animate Form, Princeton Architectural Press.
- Menges, A.: 2012, AD: Material computation: Higher Integration in morphogenetic design, Volume 8, No 2, Wiley
- Nerdinger, W.: 2005, Frei Otto Complete Works: Lightweight Construction, Natural Design, Birkhauser.
- Picon, A.: 2003, Architecture and the Virtual, towards a new materiality, in Wissenschaftliche Zeitschrift der Bauhaus-Universität Weimar Heft 3
- Spuybroek, L.: 2002, The Structure of Vagueness, in TransUrbanism, V2 publishing.
- Woodbury, R.: 2010, Elements of Parametric Design, Routledge.
- Yessios, C.: 2003. Architecture in the Digital Age: Design and Manufacturing, Spon Press.

## Articulated Surfaces:

### *A Parametric Approach to Form-Finding and Structural Evaluation*

**Michele Calvano**

*Sapienza University*

*Rome, Italy*

*michele.calvano@uniroma1.it*

**Alfonso Oliva**

*LERA*

*New York, United States*

*alfonso.oliva@lera.com*

**Mia Tsiamis**

*LERA*

*New York, United States*

*mia.tsiamis@gmail.com*

**Abstract:** The objective of this research is to explore the ability of folded origami tessellations to adapt to free-form surface configurations in the context of architectural and engineering applications. The relationship between origami pattern variables, the geometry of the associated folded form, and the structural behaviour of the folded form on an architectural scale are studied. The study aims to answer the question: Does function follow fold? A parametric workflow provides the platform for evaluating the effect of fold pattern variations on the structural performance of the folded geometry and computational methods are used to optimize the performance of the structure.

**Keywords:** *Miura-ori; tessellation; Structural analysis; Architectural geometry; Optimization.*

## 1. Introduction

Articulated surfaces are multi-faceted surface approximations which are generated by folding a pattern into a 3-dimensional form. The first part of the research focuses on the parametric construction of the Miura-ori origami tessellation and the kinematics of folding this pattern. Visual scripting using Grasshopper in Rhino is used to digitally simulate folding of the Miura pattern and to explore how the form of the folded tessellation can be adapted to various mathematical surfaces.

In the second part of the research, the structural behaviour of folded Miura tessellations which have been distorted to match three types of target surfaces is evaluated in order to gain an understanding of how variation in the fold pattern affects the strength and stability of the overall folded form. With this understanding, the folded plate structures can be optimized for structural performance and constructability.

## 2. Fold geometry and movement.

Folded surfaces derived from origami tessellations are composed of a unit module that is repeated over a surface area. The geometry of the unit module can be broken down into rigid panels which are connected along their edges by hinges, which enable movement of the panels relative to one another. With an understanding of the kinematics of the unit module, the movement of the entire surface pattern can be controlled.

## 2.1 The Surface Pattern

A tessellated surface pattern is created by repeating the basic folded unit module in a regular pattern. This composition of folded unit modules creates a network of mountain and valley folds that allow the model to move and assume various geometric configurations as illustrated in Figure 1.

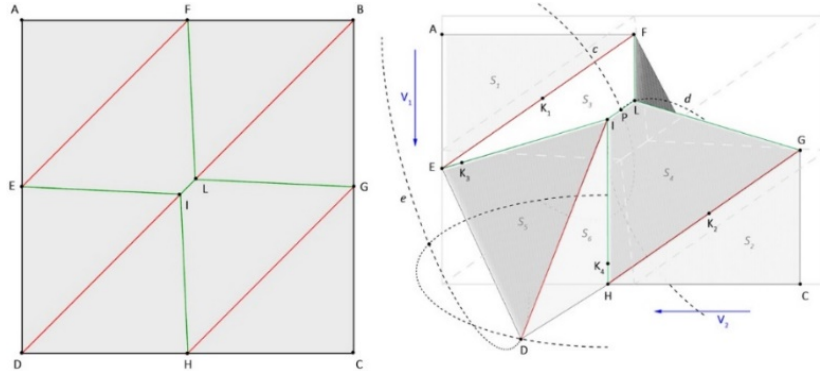

Figure 1. The module surface; geometric transformation based on rotation about fold lines

An explanation of the kinematics of the unit module is provided in *Architettura delle superfici piegate. Le geometrie che muovono gli origami* [The Architecture of Folded Surfaces. Geometries that Move Origami] (A. Casale, G. M. Valenti, 2013). A geometrical approach is used to describe the movement of the rigid panels of the unit module based on fold line designation (as mountain or valley fold), but control of the overall surface pattern movement is not addressed. This paper discusses a method for controlling the movement of the surface pattern within digital space, by simulating the topological conditions and the physical forces that can act on a surface pattern to inform its overall configuration. With visual programming it is possible to develop an algorithm that allows the folded tessellation to be constructed parametrically and its movement to be controlled by applying digitally simulated forces to the folded geometry to generate various 3-dimensional surface configurations. The subsequent sections discuss this process in more detail as it applies to the Miura-ori tessellation.

## 2.2 Unit Module and construction of the pattern

The first step is to design the unit module, as shown in Figure 2a. This unit module consists of quadrilateral panels defined by mountain and valley fold lines. The designation of the fold lines as mountains and valleys is based on the reverse fold mechanism, in which folding occurs simultaneously about two orthogonal axes, as shown in Figure 2c.

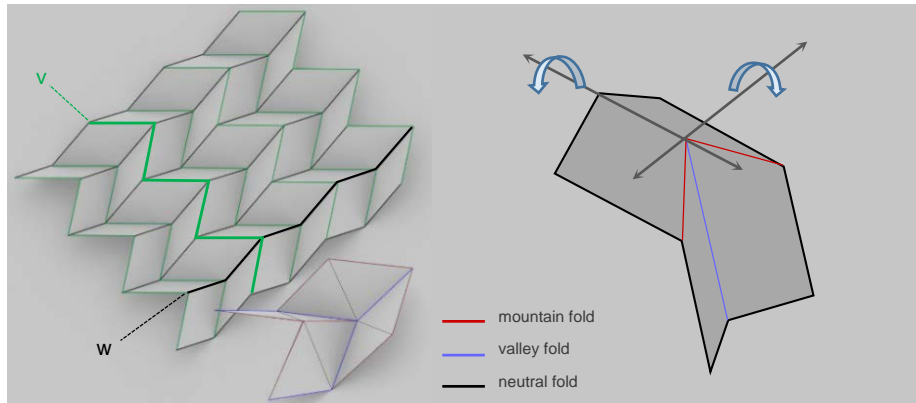

Figure 2. a) Miura pattern unit module; b) surface pattern; c) Folding axes of reverse fold lines.

The module was parametrically modelled in Rhino using Grasshopper in a partially folded state in order to facilitate the algorithm which applies forces to generate movement. This unit module is then repeated to build a pattern over a surface area. Any duplicate edges in the resulting array are eliminated to ensure that each panel in the surface pattern shares a single edge with adjacent panels. The mountain and valley lines of the surface pattern can be described as polygonal chains  $v$  and  $w$  (heretofore referred to as 'zig-zags' and 'strips', respectively), as shown in Figure 2b. These edge lines generated by the 'strip' and 'zig-zag' chains are then used to define a mesh consisting of quadrilateral faces. If the folded tessellation is assumed to rigidly foldable, all the polygon panels defined by the fold lines can fold continuously from a flat to a fully folded state without deformation of the panels, only hinging about the fold lines (Schenk, 2011). Since the Miura tessellation is quadrangular in nature, if all of the panels are assumed to remain rigid, the folded surface pattern will only have one degree of freedom. However, if the quadrangular mesh faces are triangulated by introducing the neutral fold line along the shorter diagonal of each quadrilateral face (A. Casale, G. M. Valenti, 2013), the pattern will be able to adapt to a doubly curved surface under the influence of applied twisting or bending forces.

### 2.3 Controlling the movement of the surface pattern

In order to simulate movement of the surface pattern in digital space, the geometric model must be converted to a system of spring elements. This is achieved using Kangaroo, a physics engine that operates within Grasshopper. The entire folded surface can then be activated by applying a bending force to the hinges between adjacent faces of the folded mesh. Varying the fold angles generates movement throughout the entire model. Controlling the degree of this angle is one method that can be used to control the configuration of the folded surface. By applying forces which pull the lowest or highest vertices of the folded surface pattern, the pattern can be guided to match the curvature of a target surface, as illustrated in Figure3.

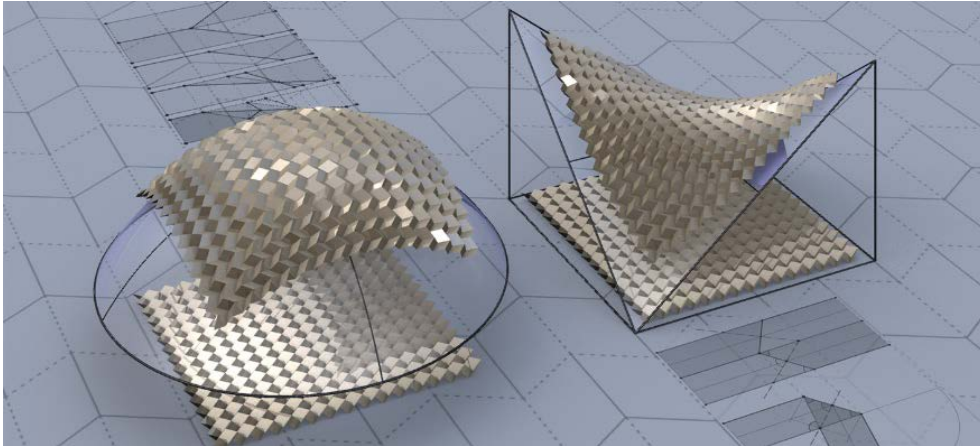

Figure 3. Miura surface pattern pulled to target surfaces

In order to fold the origami pattern, Kangaroo must balance the effect of several forces acting on the system of springs defined by the fold pattern, including the stiffness of the springs, bending force about hinges, planarization of mesh faces, and the 'PowerLaw' force which pulls the folded origami to the target surface. The strengths of each of the different forces had to be varied in order to find the combination that yielded a correctly folded mesh. Based on the combinations of strength values given to each force, it can be concluded that there must be one governing force applied to the system.

In order to accurately simulate the physical behaviour of the folded Miura surface pattern under distortion forces, additional forces must be applied to the system to prevent stretching of the mesh faces and to control planarity of the panels. Mesh stretching is controlled by limiting all edges of the triangulated mesh to a constant length. Planarity of the mesh faces is achieved by controlling the degree of bending about the neutral fold line on each mesh face. If rigid foldability is to be preserved, bending about this neutral fold should not occur, and the fold angle should be  $180^\circ$ . When the folded surface pattern is adapted to a continuous, doubly curved target surface, the bend angle about the neutral fold line can be reduced to enable further flexibility of the surface pattern.

### 3. Structural evaluation

Folded origami tessellations have an inherent flexibility that enables them to be globally distorted to match various curvatures, and at the same time, the increased second moment of area due to the folds gives folded shell structures increases stiffness (Schenk, 2011). The subsequent sections of this paper focus on evaluation of the structural behaviour of the Miura pattern.

A parametric workflow provided the platform for evaluating the effect of fold pattern variations on the structural performance of the folded geometry and computational methods were used to optimize the performance of the structure by varying pattern geometry. The following software and Plug-ins have been included in the workflow followed for this study: Rhinoceros 3D;

Grasshopper (parametric definition of fold pattern and target surface); Kangaroo (for digital simulation of fold folding); Karamba (for finite element analysis of folded form); CSI SAP2000 (for verification of FE analysis results); Microsoft Excel (for optimization loop).

The origami pattern was first defined parametrically in Grasshopper and then folded digitally using the Kangaroo physics engine. Rigid foldability, flat-foldability and developability properties of origami have been respected for this study. The folded mesh was then converted to shell elements and analysed as a concrete folded plate structure (concrete strength=16.7 MPa) using Karamba. The supports are all assumed to pins, restraining translation only. All loads are defined as mesh loads, applied to mesh vertices. The self-weight is calculated as a function of the mesh area, the thickness of the shell elements, and the unit weight of the concrete material specified. The self-weight (SW), live load (LL), and wind load ( $W_x$  and  $W_y$ ) are applied according to the global axes, while the superimposed dead load (SDL) is applied locally to the mesh. As an approximation of windward and leeward wind load, half of the wind load value is applied to all of the mesh vertices. The following table summarizes the loads and load combinations that were used in the analysis:

| Loads (kN/m <sup>2</sup> )                            | Load combinations (strength)    | Load combinations (deflection)  |
|---|---------------------------------|---------------------------------|
| $SW = A_{\text{mesh}} * t * \gamma_{\text{concrete}}$ | 1.4(DL+SDL)                     | 1.0(DL+SDL)                     |
| SDL = 0.5   | 1.2(DL+SDL) + 1.6LL + 0.5 $W_x$ | 1.0(DL+SDL) + 1.0LL + 1.0 $W_x$ |
| LL = 1.0  | 1.2(DL+SDL) + 1.6LL + 0.5 $W_y$ | 1.0(DL+SDL) + 1.0LL + 1.0 $W_y$ |
| $W(x \text{ and } y) = 1.7$                           | 1.2(DL+SDL) + 1.0LL + 1.0 $W_x$ |                                 |
|   | 1.2(DL+SDL) + 1.0LL + 1.0 $W_y$ |                                 |

Table 1. Load cases and combinations used in structural analysis

The structural analysis aimed to determine the effect of both global geometric parameters, including span, curvature, and support condition, as well as origami pattern parameters, including ‘zig-zag’ and ‘strip’ density, on the structural behaviour of the folded origami when pulled to match a target surface. Three target surfaces were studied: *paraboloid* (positive double curvature), *hyperbolic paraboloid* (negative double curvature), and *parabolic arch* (single curvature). The support conditions were also varied in order to study variations in the force flow through the



origami structure and to potentially identify a strong and weak direction of the folded origami structure. The following table summarizes the models that were studied.

|                                  |                    | SUPPORT CONDITIONS |            |     |          |            |                 |       |                 |       |          |            |  |
|----------------------------------|--------------------|--------------------|------------|-----|----------|------------|-----------------|-------|-----------------|-------|----------|------------|--|
|                                  |                    |                    |            |     |          |            |                 |       |                 |       |          |            |  |
| Target surface                   | Gaussian curvature | SPAN (m)           | HEIGHT (m) | S/H | SPAN (m) | HEIGHT (m) | PATTERN DENSITY |       | PATTERN DENSITY |       | SPAN (m) | HEIGHT (m) |  |
|                                  |                    |                    |            |     |          |            | Zig-zag         | Strip | Zig-zag         | Strip |          |            |  |
| <b>Paraboloid</b><br>            | +                  | 28                 | 10         | 2.8 |          |            | 30              | 16    | 30              | 16    | 28       | 10         |  |
|                                  |                    | 13                 | 5          | 2.6 |          |            | 50              | 16    | 50              | 16    |          |            |  |
|                                  |                    | 5                  | 2          | 2.5 |          |            | 15              | 16    | 15              | 16    |          |            |  |
|                                  |                    |                    |            |     |          |            |                 | 30    | 32              | 30    | 32       |            |  |
|                                  |                    | 28                 | 28         | 1   |          |            | 8               | 32    | 8               | 32    |          |            |  |
|                                  |                    | 28                 | 6          | 5   |          |            |                 |       |                 |       |          |            |  |
| <b>Hyperbolic paraboloid</b><br> | -                  |                    |            |     |          |            | 30              | 16    | 30              | 16    |          |            |  |
|                                  |                    |                    |            |     |          |            | 50              | 16    | 50              | 16    |          |            |  |
|                                  |                    |                    |            |     |          |            | 15              | 16    | 15              | 16    |          |            |  |
|                                  |                    |                    |            |     |          |            | 30              | 32    | 30              | 32    |          |            |  |
|                                  |                    |                    |            |     |          |            | 8               | 32    | 8               | 32    |          |            |  |
| <b>Arch</b><br>                  | 0                  |                    |            |     | 28       | 10         | 30              | 16    | 30              | 16    |          |            |  |
|                                  |                    |                    |            |     | 13       | 5          | 50              | 16    | 50              | 16    |          |            |  |
|                                  |                    |                    |            |     | 5        | 2          | 15              | 16    | 15              | 16    |          |            |  |
|                                  |                    |                    |            |     |          |            | 30              | 32    | 30              | 32    |          |            |  |
|                                  |                    |                    |            |     | 28       | 28         | 8               | 32    | 8               | 32    |          |            |  |
|                                  |                    |                    |            |     | 28       | 6          |                 |       |                 |       |          |            |  |

Table 2. Summary of analysis models.

### 3.1 Optimization

In order to compare the various origami models in terms of utilization, the maximum utilization (calculated as Von Mises stress/material yield strength) for all models should be approximately 1. For each model an iterative loop evaluates the maximum utilization of all shell elements at a given thickness. For each new thickness, it applies an updated self-weight, and calculates the Von Mises stress in each shell element and compares it to the material strength. If this utilization is greater than 1 or less than 0.6, then a new thickness must be tested. If the utilization is greater than 1, the thickness is increased by a percentage of the current input thickness. If the utilization is less than 1, the thickness is decreased by a percentage of the current input thickness. This iterative process continues until the following criteria are met:

| Optimization criteria  |
|--|
| • $0.6 \leq \text{maximum utilization} \leq 1$                             |
| • maximum vertical displacement < displacement limit ( $L/240$ )           |
| • change in material volume between iterations $n_i$ and $n_{i-1} < 10m^3$ |

Table 3. Criteria for exiting optimization loop

Initial analyses of the folded origami structures revealed that the structure was sensitive to buckling for various combinations of loading and shell thickness distributions. Therefore, the optimization process is based on second order analysis, which takes into account the effect of the in-plane forces in the shell elements on their stiffness during loading.

When the optimization routine yields a large range of different thicknesses for a folded structure, an additional step in the routine can group the optimized thicknesses into ranges to

reduce the amount of variability. For construction, it is preferable to have only a few different shell thicknesses in order to reduce the number of unique elements that need to be fabricated. However, for the purpose of comparing structural behaviour, this large variety of thicknesses is acceptable.

### 3.2 Observations from analysis.

The optimization loop was limited to 30 iterations, however many models with opposite edges supported did not achieve a maximum utilization of 1.0 within these 30 iterations. This was because there were often a few elements along the unsupported edges that were overstressed and the optimization loop continued to add material to these elements. For future analysis, an edge beam along unsupported edges or a diaphragm between the folds along unsupported edges will be added to the structural model to stiffen the free edges.

### 3.3 Analysis results

The analysis aimed to answer the following questions: How does span, curvature, and boundary condition affect the "efficiency" of the folded structure, compared to a shell surface of similar shape? How does pattern density and pattern direction affect the efficiency of the folded structure?

In the assessment of the analysis results, a model was considered to be "more efficient" if more elements achieved a utilization closer to 1, if less material volume was required per unit area, and if the vertical displacement was less. A total of 86 models were analysed, and for each analysis the numerical results of element utilization, vertical displacement, and volume per unit surface area were collected and plotted as shown in the representative set of results in Figure 5. Graphical results displayed in the analysis model (Figure 6) were used to verify expected behaviour under the assigned loading.

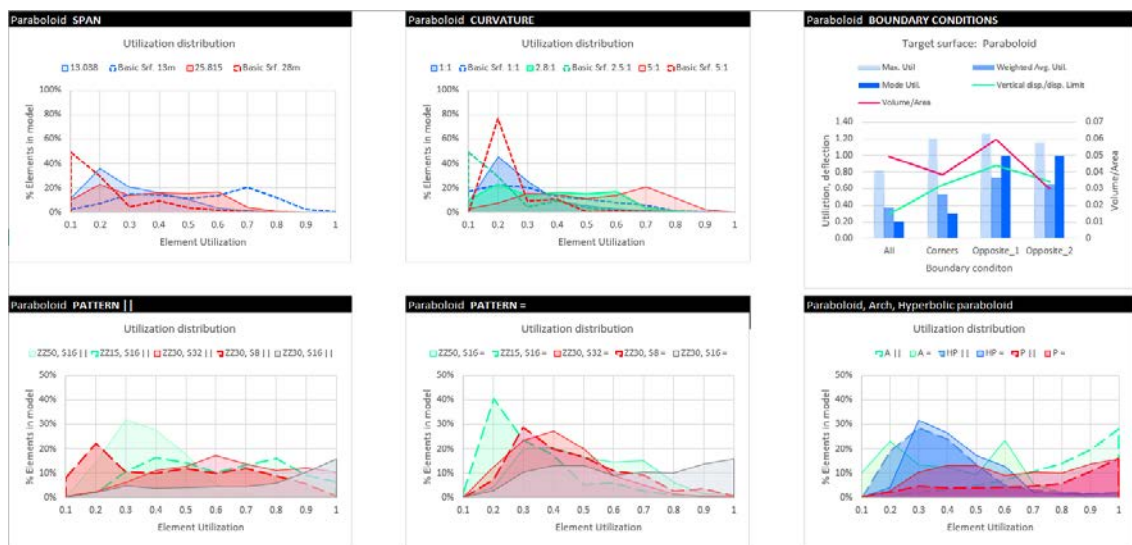

Figure 5. Analysis results plotted for Miura tessellation pulled to paraboloid target surface

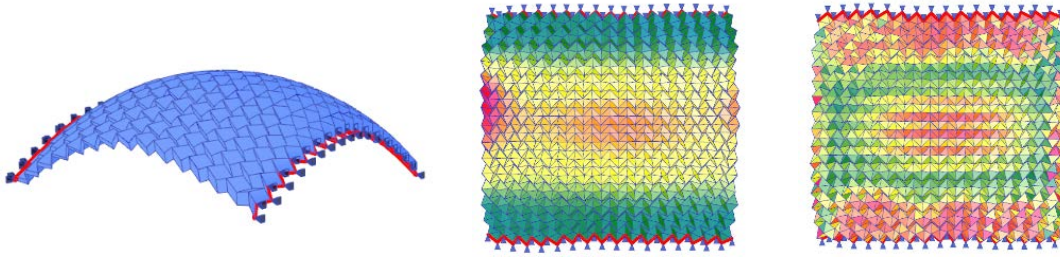

Figure 6. (a) Model analysed; (b) Utilization distribution; (c) Vertical displacement

The following conclusions can be drawn from the analysis results. Shell element utilization in all cases are generally low due to sensitivity to buckling, since buckling will occur before the element stress reaches the material capacity. As the degree of curvature of the surface decreases, the folded Miura tessellation becomes more efficient than the standard shell surface. Increasing the span yields a greater volume of material but a slightly more efficient structure, with a similar utilization distribution to that of a standard surface with a shorter span. As the curvature decreases (span to height ratio increases), the structure becomes more efficient, unlike the basic surface, which appears to be more efficient at higher curvatures. Form-matching to a paraboloid surface yields a more even distribution of element utilizations, while the folded tessellations is least efficient when adapted to a hyperbolic paraboloid. Comparison of the results for supports along opposite edges shows that the folded structure performs more efficiently when supported along opposite edges<sub>2</sub> rather than along opposite edges<sub>1</sub>. This suggests that the strong axis of the pattern is the 'strip' axis (refer to Figure 2). Fewer 'zig-zags' in the Miura pattern yields a deeper structure which is more efficient, while more 'strips' in the Miura pattern, which introduces more folds, yields greater structural efficiency. The results of the research suggest that there is real potential to apply the design process developed in the research to the design of folded plate structures derived from origami tessellations on an architectural scale.

## References

- Casale, A. and Calvano, M.: 2012, Castelli di carta. La piega per la costruzione di superfici articolate, in *DisegnareCon*, vol-ume. 5, Is-sue 9, Bologna, 309-316.
- Casale, A. and Valenti, G.M.: 2013, *Architettura delle superfici piegate. Le geometrie che muovono gli origami*; Edizioni Kappa.
- Issa, R.: 2013, *Essential Mathematics for computational design*.
- Leonardo, B.: 2010, I poliedri e le tecniche di tassellazione delle superfici continue: un nuovo punto di incontro, in *Attualità della geometria descrittiva*, Gangemi Editore.
- Lang Robert, J.: 2011, *Origami Design Secrets: Mathematical Methods for an Ancient Art*, sec. ed. AK Peters.
- Schenk, Mark: 2011, *Folded Shell Structures*. Thesis. University of Cambridge.

## Folding as a Language of Design

**Paul Jackson**  
**MA, Univ Coll London**

[www.origami-artist.com](http://www.origami-artist.com)

[www.facebook.com/foldinganddesign/](http://www.facebook.com/foldinganddesign/)

[origami@netvision.net.il](mailto:origami@netvision.net.il)

**Abstract:** The last decade and more has seen the rise of folding as a language of design, not just in architecture, but in all areas of design. This interest from designers is paralleled by the rise of folding as a subject studied by mathematicians, engineers and scientists.

Why this sudden universal flood of interest? What does folding have to offer the designer? Is it a craze, or can we now consider folding to be a mainstream language of design? In his presentation, Paul Jackson will attempt to answer these questions and to pose new ones, based on his experience teaching hundreds of 'Sheet to Form' workshops and projects across Europe with designers and students of design, since 1983. He is the author of several books about folding and design, including 'Folding Techniques for Designers' (2011), which has become the standard text on the subject.

### 1. Introduction

All designers fold.

That is, all designers crease, pleat, bend, hem, gather, knot, hinge, corrugate, drape, twist, furl, crumple, collapse, wrinkle, facet, curve or wrap two-dimensional sheets of material, and by these processes of folding, create three-dimensional objects. These objects will perhaps not be origami-like in appearance, or the folding may only be a detail, but most will nevertheless have been folded wholly or in part, in some way. Since almost all objects are made from sheet materials (such as fabric, plastic, sheet metal or cardboard), or are fabricated from components to make sheet forms (such as bricks to make a wall – a wall is a sheet form) folding can be considered one of the most common of all design techniques.

And yet, despite being so ubiquitous, folding as a design topic is rarely studied. Perhaps this is because the folded content in a designed object is often unrecognised, or merely incidental, or because folding is synonymous with origami, with brightly coloured squares and children's hobbycrafts (an image of origami now several decades out of date). Folding is rarely an inspiration for designers.

At least, that's how it used to be. In recent years, more and more designers of all disciplines have turned to folding to create a wide range of hand-made and manufactured objects, both functional and decorative. A little research looking through design and style magazines will reveal a significant number of folded products, from appareil to lighting and from architecture to jewellery. 'Origami' is one of the most vibrant buzz words in contemporary design. (Jackson 2011)

## Folding as a Language of Design

We should not overlook the penetration that folding has into language, not just in English, but in all languages with Latin roots. The Latin for 'fold' is 'pli', 'plicare' or 'plex and in Ancient Greek, 'plectos'. A random sample of more than four hundred fold-related words in English would include:

*Diploma Diplomat Complex Complicate Duplicate Triplicate Replicate  
Implicate Plywood Application Apply Applique Compliant Complied  
Compliment Explain Explicit Implicate Imply Multiply Simplify Pliable Pliers  
Replica Split Crumple Solar-plexus Perplex Reflex Reflection Deflect  
Genuflect Flex Flax*

Clearly, few of these words apply directly to design. Instead, they cover a wide-range of human thoughts, situations, actions and objects.

In this way, the concept of folding should not be regarded simply as a technique of manipulating materials, but as a concept that goes to the heart of what it is to think, feel and live as a human.

### 2. The Distinctiveness of Folding

Almost all manufactured objects are made by assembling a number of separate parts: for example, an automotive vehicle is made from thousands of individual components. A very few objects, such as marble sculptures, are made by a non-reversible process of reducing one block of material to its final form, by subtraction.

By contrast, in its most refined form, folding neither adds nor subtracts material; it transforms a material from one state to another by the process of folding. In most cases, this transformation is reversible by the process of unfolding.

In this way, folding offers a unique language of design, in which, in its purest form of expression, an object is made from one piece of sheet material. The forms and surfaces possible from this transformative method of manufacture are predominantly elegant, economical and necessarily rational. The language of folding can become increasingly additive in nature if a combination of materials is used or if the sheet is cut or joined to others, until at some point, an object loses the folded aesthetic and becomes a piece made by the more conventional additive process. The distinctiveness of folding as both a process of manufacturing and as an aesthetic styling creates products with a strong visual identity.



[www.dreamstime.com](http://www.dreamstime.com)

Additive



Subtractive

[www.coolclips.com](http://www.coolclips.com)



Figure 1. The Additive, Subtractive and Transformational Methods of making objects. Folding is unique because it neither adds nor subtracts materials during the process of making, but transforms them.

### 3. Folding in One, Two and Three-dimensions

It is commonly assumed that folding exists only as a technique that changes a two-dimensional sheet of material into a three-dimensional form. While this transformation is by far the most common, folding also exists in one-and three-dimensions. Here is an explanation of how folding differs in each of the three dimensions.

#### 3.1 One-dimensional Folding: the Folding of Lines

A line is the connection between two points, that has length but no width. It is an imaginary mathematical conjecture, but in the real world, many things are described as 'linear' and they fold. In nature, for example, folding is a common form of movement for linear creatures such as snakes. Also, the joints of human bodies are linear, so that our bodies fold as we move.



[www.schoolclipart.biz](http://www.schoolclipart.biz)

Figure 2. Yoga positions as an example of linear folding

In the manufactured world, lengths of yarn, wire and other linear materials knit or weave themselves to create all-manner of surfaces from cloth to wire fences, to cables to baskets. The creation of sheet surfaces by folding linear materials is perhaps the most common of all making techniques.



## Folding as a Language of Design

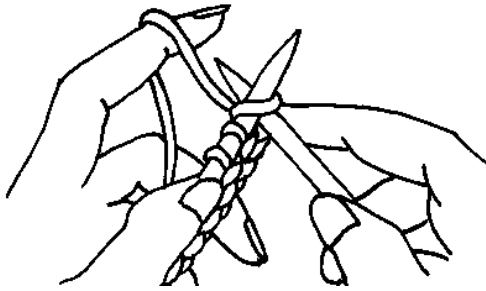

www.clipartpanda.com

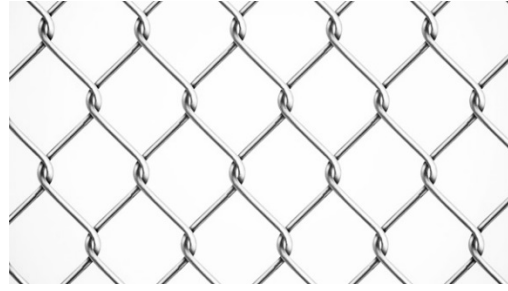

www.4vector.com

Figure 3. Examples of linear folding as knitting and as a wire fence

### 3.2. Two-dimensional Folding: the Folding of Sheets

A sheet is a two-dimensional plane of material. In nature and in manufacturing, it is the most common of all the different dimensional forms of folding, popularised by the art of origami. Nature has many examples of two-dimensional folding, ranging from the geometry of a folded leaf to the non-geometric crumpling of the brain.

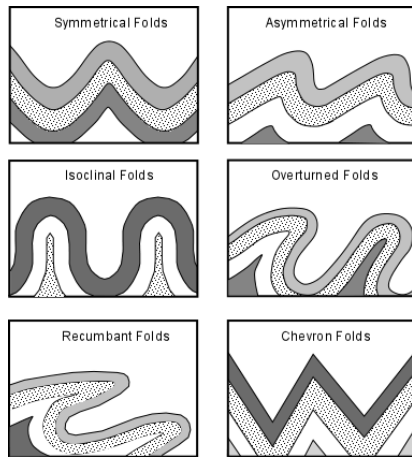

[www.tulane.edu/~sanelson/eens1110/deform.htm](http://www.tulane.edu/~sanelson/eens1110/deform.htm)

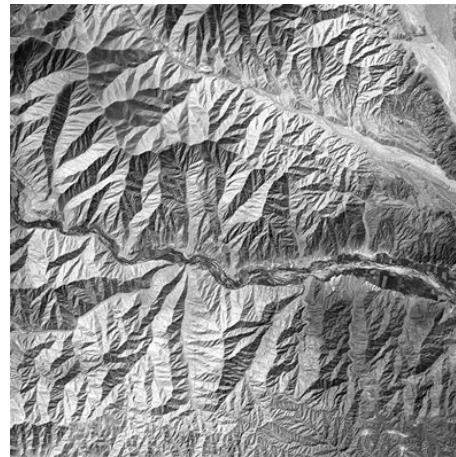

© Google Earth (Northern China)

Figure 4. Examples of folding in geology

Since almost all manufactured objects are made from sheet materials, the incidence of folding – especially if using the broader definition of folding described in the Introduction, above – is virtually ubiquitous, in every material and combination of materials imaginable.





© Hadar Grizim, Shenkar College of Design, Tel Aviv, Dept of Textile Design  
Figure 5. Scarf with a pleated woolen surface. Example of student work.

### 3.3. Three-dimensional Folding: the Folding of Volumes

A volume is a solid mass of material. When folding in three-dimensions, the material is folding in every direction simultaneously, a concept difficult to imagine. In nature, examples of three-dimensional folding include sound waves travelling through the air and the flow of molten lava.

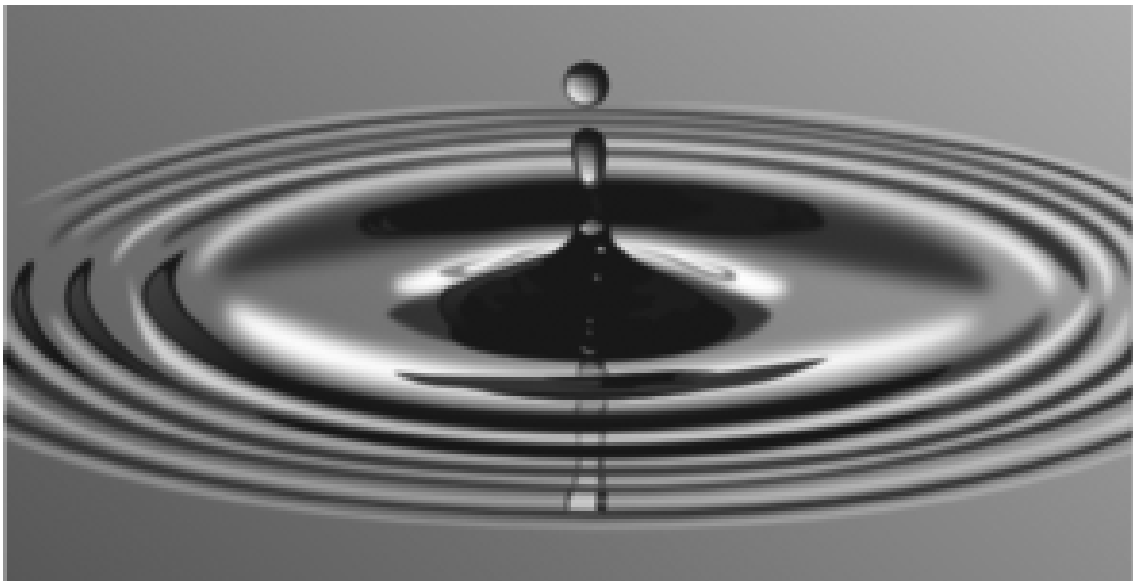

Figure 6. <http://www.clker.com/clipart-water-drop-with-ripple.html>

In manufacturing, ingredients for materials such as concrete, clay and dough are mixed together by a process of three-dimensional folding to achieve an even consistency.

## Folding as a Language of Design



<http://betonmontreal.com/>



<http://nobacks.com/bread-twenty/>

Figure 7

### 4. Different Forms of Two-dimensional Folding

Since two-dimensional folding is by far the most common, most diverse and the most useful form of folding, it will be useful to look closer at the principle different approaches to folding sheet materials.

#### 4.1 Folding to Enclose Volumes

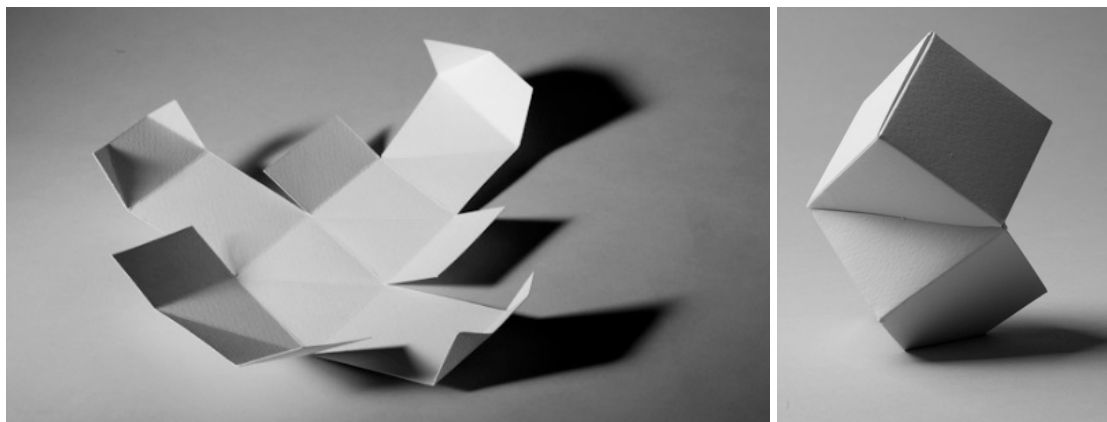

Examples created by students from the HfS, Schwabisch Gmund, Germany

Figure 8. A self-locking, glueless solid, folded from the net on the left (Jackson 2012)

Sheet materials can be folded to create volumetric forms clad in a sheet material. Further examples could include white goods (washing machines, refrigerators, etc), vehicles and carton packaging.

#### 4.2. Dynamic Folding



[www.wsj.com/articles/SB10001424052748704541304575099451035485826](http://www.wsj.com/articles/SB10001424052748704541304575099451035485826)  
<https://rosemarywashington.wordpress.com/2010/03/16/tato-pleated-coin-purse/>

Figure 9. A folding shipping container and a folding purse

Folding can be incorporated into a design to change its shape, usually to collapse or expand it. Here, a bulky shipping container is being flattened for ease of storage and transportation. It can be argued that to use folding in this way is to make maximum use of folding as a transformative action and thus makes the most effective use of its unique qualities. This form of folding has also been called 'Collapsibles' (Mollerup)

#### 4.3. Passive Folding

## Folding as a Language of Design

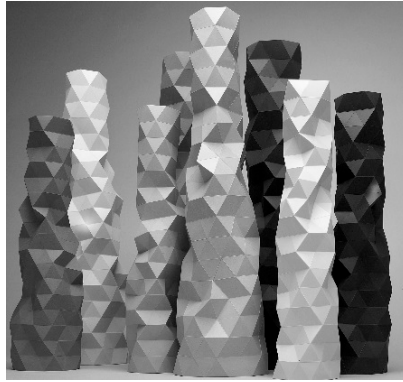

Phil Cuttance

JJ Pan

& Associates

Figure 10. Examples of Passive folding, in ceramic and as an architectural façade.

Passive folding is when a designed object has the appearance of being folded, but is not designed to move. It is the opposite of dynamic folding, described above. In passive folding, folding is used for its aesthetic characteristics, not for its unique transformative ability. It is styling.

### 4.4. Crumpling





Dent Chair by Bla-station

Gehry, UTS Business School, Sydney, Australia

Fig 7. Crumpled surfaces made in milled wood (chair) and brickwork (building)

Crumpling is the antithesis of the straight-line geometry usually associated with the act of folding. It is anarchic, ironic, shocking and challenging. It is also textural rather than structural, creating a surface that appears more natural than manufactured.

## Conclusion

This short introductory paper has demonstrated that folding is a powerful and well-established design language with applications across all areas of design, using any material or combination of materials and any manufacturing process(es). It can be used as structure, as a surface texture, be functional or decorative. There is an inherent rightness in the structure of folding that makes a design rational.

As a tool for designers, its versatility is as yet barely understood. It is a design language which has the potential for great future exploration, with applications as diverse as nano-scale technology and space telescopes. What may initially have seemed to be a minor folk craft (origami) is rapidly evolving to one of the most powerful and creative design languages of our time.

## References

(Jackson 2011) P Jackson. 'Folding Techniques for Designers'. Laurence King Publishing, London, 2011. Extended quote from the Introduction.

(Jackson 2012) P Jackson. 'Structural Packaging'. Laurence King Publishing, London, 2012.

(Mollerup). P Mollerup. 'Collapsibles'. Thames & Hudson, London, 2001.

## Spatial Cognition in virtual environment

### *Spatial cognition in video games*

**Katerina Anagnostopoulou-Politou**

*Bartlett School of Architecture*

*London, UK*

[katerinanagnopol@gmail.com](mailto:katerinanagnopol@gmail.com)

**Kinda Al Sayed**

*University College London*

*London, UK*

[k.sayed@ucl.ac.uk](mailto:k.sayed@ucl.ac.uk)

**Abstract:** If spatial configuration is the main generator of natural movement in real environments, what happens when the navigation in virtual environments is mainly governed by properties of characters and not by the mathematical spatial configuration of a plan? This study is focused on the field of spatial cognition, navigation and wayfinding in the context of Half-life video game, where individuals -players- mainly navigate through by virtue of their decisions to approach certain goals (missions). The objective is to capture the correlation between space-time and observed movement in the virtual environment by analysing the video game space and conducting an experiment. The case under study is "Half Life 2 - Episode 2"; a strategy video game, with mission to find the best routes out of the virtual environment settings. Observations of players' navigation are carried out supported by spatial analysis and a new methodology named time-convex to model space-time relationships.

**Keywords:** *Space Syntax; Spatial Cognition; Video Games; Wayfinding; Navigation.*

### **1. Introduction**

Video games have changed the notion of space in time; more than the film and television did in the twentieth century (McLuhan, 1951, 1962, 1997; Barthes, 2000). The representation of players in digital spaces, avatars, culminate the creation of the illusion of reality. A pseudo-physical space that can extend from the two dimensions to three dimensions with a full package of social and 'object' interactions.

This alternative reality is mainly constructed by cognitively demanding environments. Movement is influenced by the revelation of a new path and short-term events. Where real world sees a path as a corollary of space, a path in a video game is revealed after a sequence of different decisions, actions and movements. Video games as cognitively demanding environments make obvious the need for conducting thorough research in order to obtain information about the processes of spatial cognition.

This research takes the theoretical background of spatial cognition and focuses on studying the video game environment by exploring the space-movement relationship and trying to find new patterns of cognitive processes and navigation, by using the theory and tools of Space Syntax.

In addition to syntactic analysis, the study entails a novel analysis named “time-convex”, which is an attempt to understand the patterns of movement and wayfinding in correlation with time. The combination of this analysis with space syntax analysis enables a preliminary understanding of how individual behaviour could be used to explain the cognitive processes of movement in virtual environments. The analyses were carried out using the plans of the six stages of “Half-life: Episode Two”, which were designed by the author.

## **2. Research questions**

The following research questions attempt to understand the spatial qualities and characteristics of video games and their implications in spatial cognition: 1. What are the spatial characteristics of the spaces in Half-Life, where players are spending their exploring and decision-making time? 2. How players move in Half-Life when they know their destination? 3. Where do players die in Half-Life video game?

For the research questions; three hypotheses constructed as well:

Hypothesis 1: Players are more likely to display explorative behaviour in more spatially central (integrated) spaces. Hypothesis 2: Players prefer to follow a straight (higher value of connectivity) 'unsafe' route when they know their destination than choosing a 'zic zac', but safe route. Hypothesis 3: Players die in places where there is an excessive amount of visual and spatial information.

## **3. Methodology**

### **3.1 Experiment**

The experiment identifies a continuum of cognitive skills used of players with short experience of games environments (T1), with no experience in First Person Shooter (FSP) video games (T2) and with high experience in FPS (T3), in order to make decisions and find destinations. The last group is used as a control group.

### **3.2 Time - convex analysis**

The limitation and the challenge of this study is to conduct results in the content of spatial cognition by analysing a space that is actually a pseudo-space. Aiming to establish some links between cognition and behaviour, we analyse playing time in combination with space. We divided play-time into four categories; the exploring, the decision-making & acting, the narrative time and the time when players were completely lost in the stages of game.

### **3.3 Space syntax**

The space syntax measures that will be used include; connectivity (axial analysis), and the amount of the visual information (APR value) by using isovist analysis. Axial analysis is a fundamental quantitative analysis of space syntax. Axial maps are a representation of the structure of space “spatial configurations”.



## **Spatial cognition in virtual environment. Spatial cognition in video games.**

Isovist is a visibility field constructed from a point that represents everything that can be seen directly from a point or a space. The perimeter of the area of an isovist implies the visible area around a point or a person. A salient measure, as it introduced by Dalton et al (2010) is the Area-Perimeter Ratio (APR) or 'spikiness' of an isovist [ $APR = \frac{ISOVIST\ AREA}{(ISOVIST\ PERIMETER)^2}$ ]. The range of the value of APR can range from 0.25 (circle) to 0 (the max value of spikiness).

### **4. Recording the experience**

The main purpose of the experiment is to collect data of how players with different levels of experience in video games are navigating and moving. All the participants were unfamiliar with Half-Life video game. The experiment is 15 hours of recording in total. A sample of 10 healthy participants (3 females, 7 males, mean age: 26.6 years, range: 24 - 30 years) were asked to play "Half Life 2 - Episode 2". Whilst observing their movement and generating data for their decisions, one significant limitation is that mere observation can make it difficult to determine the reasons or intentions behind some of the different actions performed. For example, choosing to turn right might be motivated by the need to protect himself/herself from the "enemies".

In order to reduce these limitations as much as possible; many studies (Chebat, Gelinass-Chebat, & Therrien, 2005; Dogu & Erkip, 2000; Ericson & Simon; 1980, Gerber & Kwan, 1994; Holscher, Meilinger, Vrachliotis, Brosamle, & Knauff, 2007; Passini, 1981, 1984) have included verbal report protocols (speak and think aloud). In this study, participants of the experiment were asked during the task to think and speak aloud about their experience. All the participants were playing the video game in the same speed of movement and in lowest level of difficulty for the tasks. After the experiment, tracing plans were produced. The main criteria that the experiment focuses on are: 1. whether the navigator can discover or inform his present location, 2. whether a route to the destination can be found, taking as base that navigability means a successful performance at wayfinding tasks, 3. how well the navigator can accumulate wayfinding experience in space.

#### **4.1 The behaviour and thinking process of the players**

T1 tend to spend time exploring the space ('zic-zac' movement). They were focusing on all the information available to them. Determining the direction was the most important aspect of their thinking process. The need to transfer skills navigating real environments to find their way in virtual environments, was their strategy of moving. The thinking process of this team of players was from the general information to the specific.

T2 seems to play from the beginning with specific strategy. They do not tend to spend time exploring the space as their experience helps them to understand easily what they should not consider as destination. They are using for their navigation specific landmarks. When they had to choose between options, they were up to choose simpler rather than more intricate routes. The way of thinking in this team was a mix from general information to specific information, such as landmarks, and from the specific to the general according to the conditions.

T3 were the fastest in succeeding in the tasks of the game. Their characteristics were the quick decision-making and their focus on specific points. Fast movement occurred on the narrative parts of the game where the participants knew they did not need to make any further decisions, and at stages where decisions with regards to the destination were obvious for them. The parts explaining the narrative of the game were mainly the only parts that this group of players spent on exploring the environment. The thinking process of this team was shifting from the specific to the general information.

### 5. Analysing the experiments in space and time

Time was divided in four categories. Every participants had 90' of playing. The time, in total 278.32', which the players were trying to translate all the information from their experience in real environment to the virtual one is the exploring time. The decision making & acting time, in total 387.18', is the time that participants reported to know their destination and how to navigate. The 'completely lost' time is the time, in total 118.10, that the players were feeling lost. During the narrative time a third person was giving directions or feedback for the player's actions. The story-telling time was 16.64'.

Furthermore, T1 spent more than 50% of time; exploring the surroundings, perhaps reflecting on the lack of experience in video games in relation to the other two teams. The gap of time spent on exploring escalates with the participants of T2. T2 has distributed time spending more equally, with percentages in exploring time close to the percentages of the control group. This proves the importance of T3 as control group creating the baseline of the experiment. Having the routes of the participants; new plans were produced, mapping time spending on the spatial layouts of Half life video game (Fig.1).

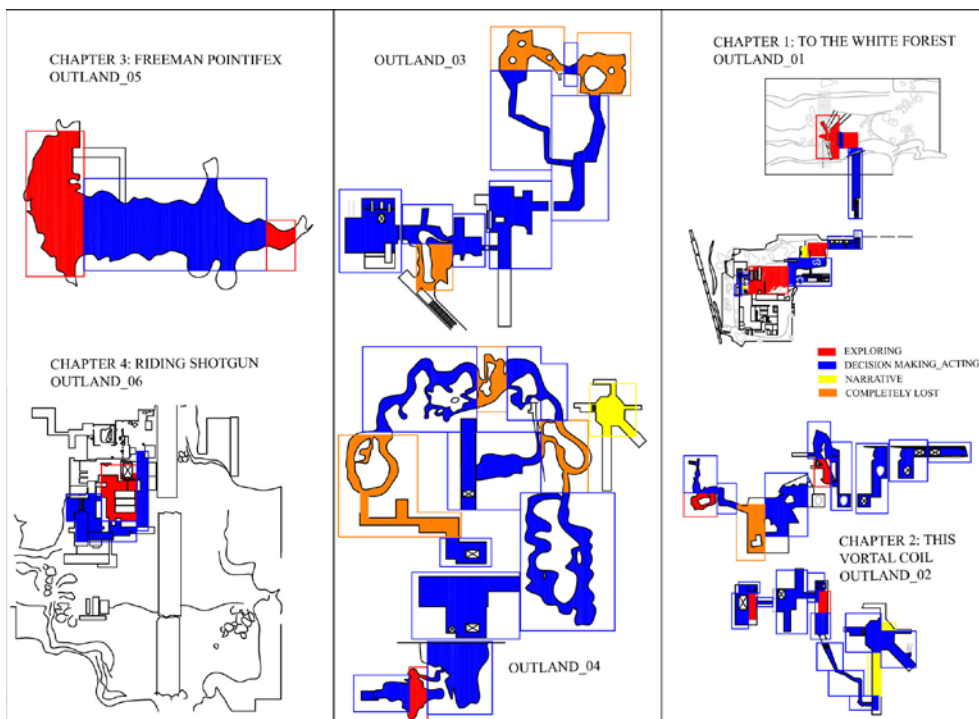

Figure 1: 'time-convex' maps

## Spatial cognition in virtual environment. Spatial cognition in video games.

### 5.1 Analysing the space

Trying to obtain a clear picture of the configuration of the stages, the syntactic computer software "Depthmap" was used to analyse the game plans. The computational analysis has been done using the textbook "Space Syntax Methodology" (Al Sayed et al. 2014). All the graphs will be presented using the Depthmap classical range of colour (Fig.2). The chosen analysis for testing of hypotheses 1 and 2 is the axial analysis.



Figure 2: Color range of classical Depthmap Software

The all-line figure (Fig.3) is a collage of the axial analysis (all-line maps) of all the Half-Life' stages. The stages with more specific -orthogonal- shapes have much lowest values of connectivity than the stages with unspecific shapes.

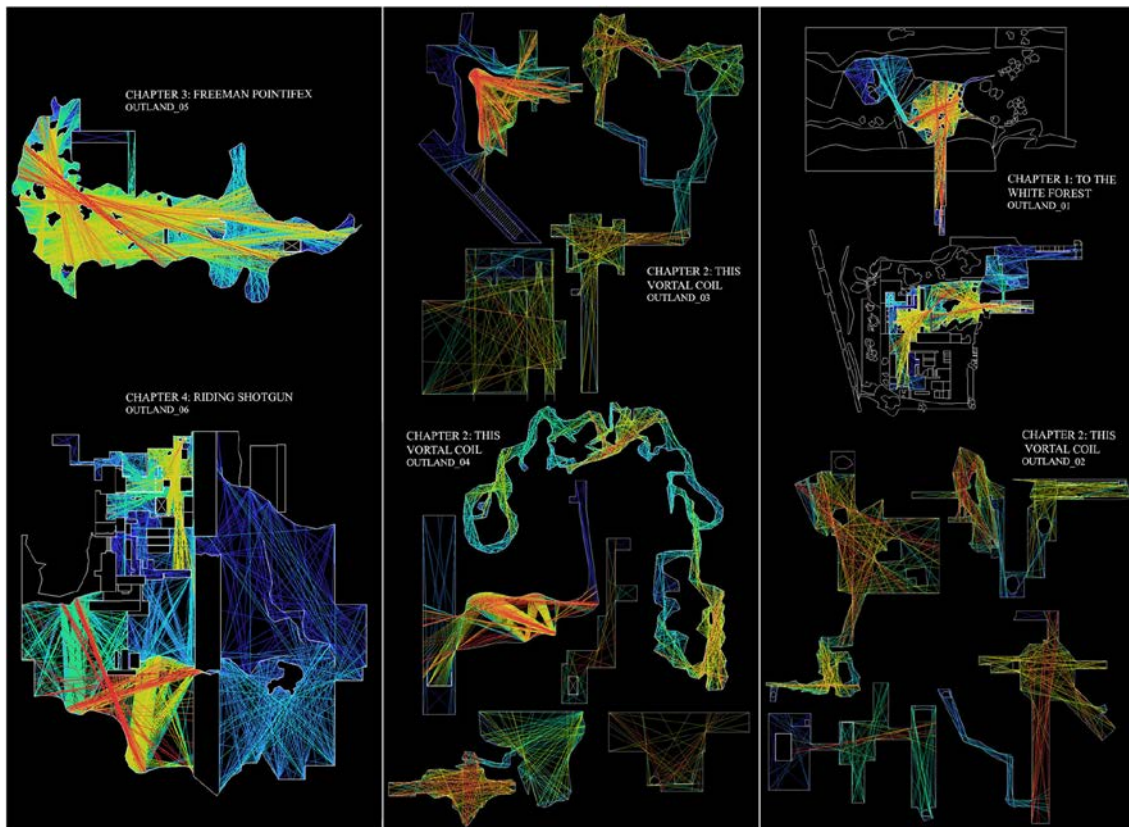

Figure 3: All-line maps

### 5.2 Results of the analysis

The combination of the axial analysis with "time-convex" analysis is being shown in figure 4. Considering again the limitations of constructing a spatial analysis close to the one of a real environment, the aspect of this map is to give the idea of the time that the users of the game spend in different parts of the stages and to extract information about the spatial characteristics of where players explore or make their decision and actions. In order the observations to be more

accurate, the narrative time and the time that the players felt completely lost will be excluded from the analysis.

The outcomes of the comparison are linked with the geometry and the psychology. People in spaces with clear geometry (orthogonal shapes) tend to walk straighter and not exploring the surroundings. In videogames environments, there are also other factors that can influence the navigation of the player, but in games like Half-Life the main character navigates mostly by his/her own perception of the space. Also, in spaces with clear shapes, players were feeling safer to act and to decide their destination. The feeling of safety, that reported in the think-aloud protocols, was result of having less information to scan objects that caught his/her attention. In spaces with unspecified shape players recorded feeling the need to explore the environment with a 'zic-zac' movement, in order to get the 'whole view' of the area.

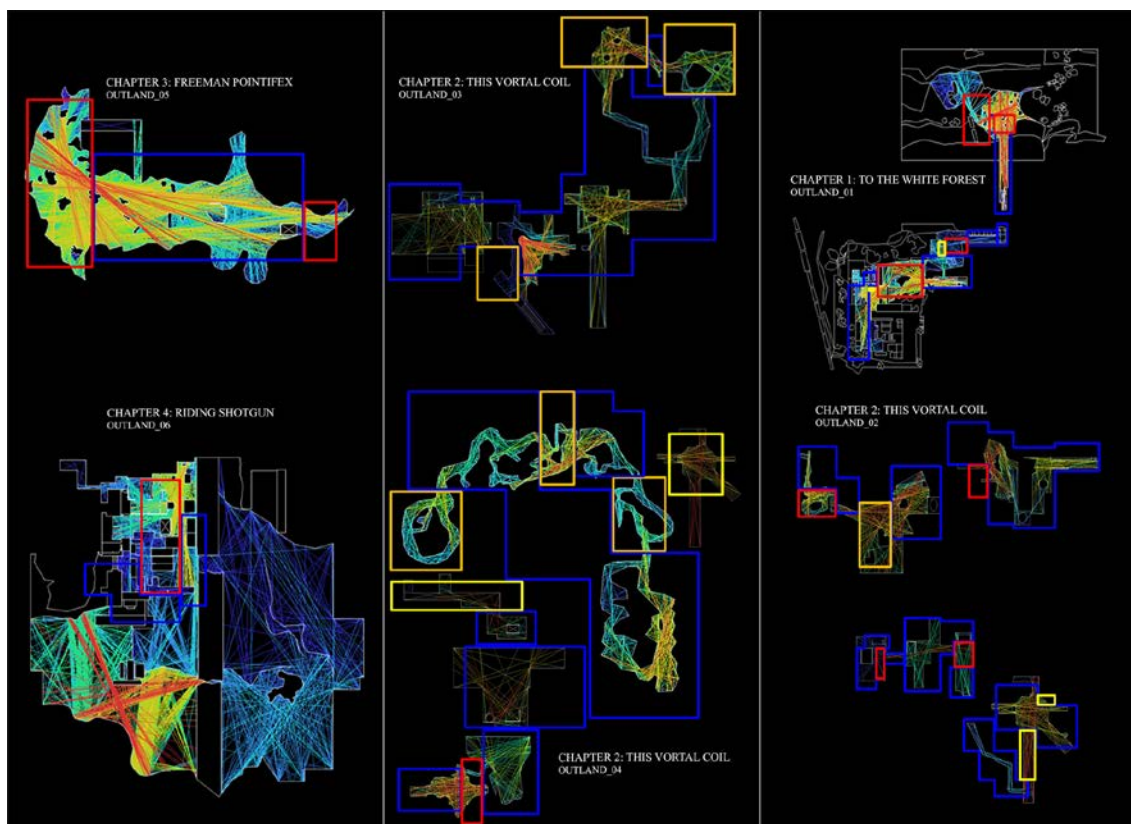

Figure 4: Axial maps and 'time-convex' maps

## 6. Why people die in video games?

If people die in places where there is an excessive amount of visual and spatial information (Hyp.3) then a noticeable measure to test this hypothesis is the 'spikiness' (Dalton et al,2010). For the purpose of this study, the points where the factors of the death caused from the design of the game (more enemies etc) excluded.

APR can range between 1/4 (perfect circle) and 0 (high value of spikiness). If the hypothesis would be correct the spikier isovist would result to the most 'deadly' stage. By extracting the geometry values from the isovist analysis; APR measured and compare them with the deadly stages (Table 1) it appears that they are close enough (outland\_04b and outland\_02

## Spatial cognition in virtual environment. Spatial cognition in video games.

are in the lower position of the descending order) but are not the same. It seems, that in this type of virtual environment, the movement and the interaction of the players are influenced by many variables, which overcome spatial characteristics.

| more DEADLY stages<br>(in descending order) | more 'SPIKY' isovist<br>(in descending order) |
|---|---|
| OUTLAND_03                                  | OUTLAND_04a                                   |
| OUTLAND_05                                  | OUTLAND_05                                    |
| OUTLAND_04a                                 | OUTLAND_06                                    |
| OUTLAND_06                                  | OUTLAND_03                                    |
| OUTLAND_04b                                 | OUTLAND_02                                    |
| OUTLAND_02                                  | OUTLAND_04b                                   |

Table 1: 'deadly' stages Vs APR

### 7. Contributions of the research & further study

The analyses confirmed two of the hypotheses and disproval the third. Variables as the design of the game influence the players behaviour, movement and understanding of the space. This study tried to exclude many of these factors, in order to extract findings that can be related with cognitive processes that take place in real environments. The results have to be carefully considered as there is a need for a greater diversity of analysis of the relation of time and space in cognition processes to establish more definitive answers and advance this early study.

A further study would be the creation of a highly accurate virtual reality simulation to explore what thoughts are associated with wayfinding, in relation to higher resolution time segments, 3D space and eye-tracking. Another factor that can progress this study would be the opportunity to test how people move and react playing the same stages in different versions (black & white, no enemies, be able to change the speed of moving).

### References

- Al\_Sayed, K., Turner, A., Hillier, B., Iida, S., 2014, Space Syntax Methodology, teaching textbook for the MSc SD:AC course (draft version 3), Bartlett School of Architecture, UCL
- Barthes, R., 2000 [original 1957], Mythologies, selected and translated by A. Lavers. London: Vintage
- Chebat J-C, Gelinac-Chebat C, Therrien K., 2005, Lost in a mall, the effects of gender, familiarity with the shopping mall and the shopping values on shoppers wayfinding processes, Journal of Business Research, 58(11):1590–1598
- Conroy-Dalton, R., Dalton, N., Marshal, P., 2010, Measuring environments for public displays: A space syntax approach, A report of an on-going project, Atlanta, Georgia
- Hölscher C, Meilinger T, Vrachliotis G, Brosamle M, Knauff M., 2007, Up the down staircase: wayfinding strategies in multi-level buildings, Journal of Environmental Psychology, 26(4):284–299

Katerina Anagnostopoulou-Politou, Kinda Al Sayed

- McLuhan, H. M. ,1951, *The mechanical bride: folklore of industrial man*
- McLuhan, H. M., 1962, *The Gutenberg galaxy: the making of typographic man*, London: RKP
- McLuhan, H. M., 1997, *Understanding media: the extensions of man*, London: Routledge
- Passini R., 1981, *Wayfinding; A conceptual framework*, *Urban Ecology*,5:17-31
- Passini R., 1984, *Spatial representations, a wayfinding perspective*, *Journal of Environmental Psychology*, 4:153–164

## Game based social housing

### *Relocating populations via game based participation*

**José Beirão**

*University of Lisbon*

*Lisbon, Portugal*

[jnb@fa.ulisboa.pt](mailto:jnb@fa.ulisboa.pt)

**M<sup>a</sup> Inês Chora**

*University of Lisbon*

*Lisbon, Portugal*

[ineschora@gmail.com](mailto:ineschora@gmail.com)

**José Frutuoso**

*University of Lisbon*

*Lisbon, Portugal*

[arquitecto.frutuoso@gmail.com](mailto:arquitecto.frutuoso@gmail.com)

**Abstract:** This work explores the challenges of translating rules for a Serious Game social-housing plan strategy into a computer simulation that integrates the lessons learned from test scenarios carried out with physical models. The model implementation combines shape grammars, a parametric design platform and a game interface built for participation.

**Keywords:** *Serious Games, Participatory Process, Urban Rehabilitation.*

## 1. Introduction

This work shows the advantages of Gaming, seen from a Serious Games perspective, in the urban planning process, specifically in a social-housing relocation context.

The work is set within the Barruncho District in Odivelas, Portugal, a multicultural spontaneous neighbourhood composed mainly of shacks and several kinds of precarious constructions. A participatory approach is proposed which opens participation to the neighbourhood residents, using the Game as a negotiation interface and field confrontation between global and common needs (Mayer et al, 2009).

This method allows for in situ resettlement through an incremental strategy following the sequence build → rehouse → demolish ensuring participation, self-awareness of the development of planned implementations and making sure the process does not stagnate. The gaming process can either take on a handmade game approach, mimicking strategy board games to enhance participation in city design, or it can also use computer game environments to test different developments hypothesis (Tan, 2009) (Venhuizen, 2010). In our case, test scenarios resorted to a physical Board Game created as a tool for testing the evolution of a relocation process, making the participatory process a familiar process. The Game Board represents the Urban Plan, and urban transformation rules establish the rules to play the game. The rules are defined in terms of a set of transformations – selection (semantic attribution); addition (build); subtraction (demolition) – that applied in a game like environment allows participants to negotiate options and eventually agree on a plan solution including a phased approach for implementation.

This paper explores the challenges of translating rules initially built for physical models into a computer simulation game that integrates the lessons learned from the various test scenarios.

## 2. The Site



The Barruncho District is located in the municipality of Odivelas, Portugal. Even though Odivelas contains an historic center in its urban tissue, the mentioned areas are essentially suburbs of Lisbon and function mainly – but not exclusively - as dormitories. Barruncho is an illegally settled neighborhood of small dimensions, but relatively consolidated. Nevertheless, the streets or pathways are narrow, do not have any type of pavement and are of great instability, being prone to landslides. All the houses are single-family with one floor and the different groups of houses correspond to different community groups. The existing houses are in varying states of preservation and stability, and the majority does not meet the basic infrastructure and health needs. Households are mostly overcrowded and have quite reduced dimensions sometimes as small as 15 square meters. The population is composed of different communities from different cultural backgrounds. Cultural differences essentially stem from different ethnic origins. People co-exist within smaller groups and do not try to know each other to avoid conflicts. Contrasting with surrounding areas, the population is very young. The level of education is low, and the active population works in sectors requiring few qualifications, and consequently has low incomes.

The work shown in this paper was developed in academic context involving a design studio, a master thesis dissertation and a course on parametric design. The Odivelas municipality supplied official information on the neighborhood. The aim was the rehabilitation of the Barruncho District, aiming at integrating a new urban area in the context, regenerating the negative image of the neighborhood and improving living conditions. The urban plan should fit within a participation panorama by using customization methods for housing, and creating an intuitive interface for participation.

### **3. State of the Art**

The concept of Serious Games was introduced by Clark Abt in 1970, in his book of the same name, which explored how games could be used as educational tools, as well as for planning and simulation in a variety of fields.

“(…) Serious Games are a combination of analogue and digital game concepts and techniques that are deliberately designed and/or used as an intervention to enhance learning at the individual, organizational or systems level.” (Mayer et al. 2009, pp 171)

The idea is to test different hypothetical scenarios and connect the "desired objectives" of different parties, putting them in confrontation before they have an impact on reality. The first examples shown in ((Shubik, 1975) mentioned in (Mayer et al. 2009)) are associated with war scenarios used to study situations that may arise in conflict. Applied to the field of urbanism and architecture, there have been various types and game concepts, including digital simulation, of which the SimCity game is the most recognized example. In it, the player can build a city and manage it. Often, simulations are set apart of the design process, with separation of who sets the model and who draws the plan, which does not produce the most useful results. Progressively, the panorama is gearing towards the approximation of simulation methods to final users by opening the process to different actors who can act together on the same plane (Mayer et al, 2009). More recently, relevant experiences of such systems have been carried out by the

## **Game based social housing**

collective The Responsive City, and developed a series of urban games to explore different planning scenarios. (Tan, 2009)

Games can be used as a communication interface with the various stakeholders in the simulation of urban developments. They provide an intuitive simulation environment while simultaneously providing awareness on the complexity and impacts involved in planning decisions. Moreover, it transforms an otherwise unappealing process, into a more dynamic and engaging initiative. Games therefore allow for the democratization of the design process, encompassing new actors, and opening the space of dialogue on architecture and urban planning to individuals that had no previous participation in the discussion.

### **4. The Game**

In this section we explain the approach taken in the Barruncho District. In order to make the participatory process recognizable and familiar, the bases were established in analogy to a traditional board game. To achieve such analogy we assumed the Urban Plan as an equivalent to the Gameboard, families in need of resettlement and new occupants are the Players, and urban rules, organization and staging as the Rules to advance in the game. The Game is described here as it was set in the context of the mentioned master thesis for simulating a possible real game application.

#### **4.1 Gameboard**

The design of the urban proposal is defined by the Architect and team. It may be an urban plan already set or first approaches on possible scenarios that we want to test. It aims at the integration of the site in the urban system, but also at restructuring the environment itself, by introducing order through rehabilitation and clear development guidelines. What is set to be a future plan, is defined on top of the current settlement, with phasing rules and the indication of what will remain through a preservation procedure and what should be built apart from the participatory process (e.g.: public facilities, main streets and public spaces).

The new plan indicates the areas in which the Player can insert a new house. These areas are provided with all the infrastructural conditions for housing pre-established at specific locations by the plan or Gameboard. Priority areas are defined as Rules for both the demolition of the existing houses and the first construction phase, with additional predefinitions focusing on "solving" the predetermined areas first.

#### **4.2 Actors in the Game**

Architect and team - set the game board, based on contextual interpretation. They are the designers of the game board.

Local administration - develops the site, using its ability to attract players and encourage renewal. They are so to say the game manager.

Families / entrepreneurs - want a location that suits their family or business interests. They are in fact the set of players.

#### **4.3 The Deck**

Game moves are conducted by drawing cards. Drawing a card symbolizes the time when a family or business owner has the ability to invest in the home or business, and therefore "enters the urban market". The choice of location takes into account family profile or business program. Cards represent either a family or an entrepreneur. The family may be a family presently living in Barruncho or another family; the entrepreneur follows the same logic.

The Deck is composed of family profiles that need rehouse (126 families in this case) and entrepreneurs. In the case of families, each card contains information regarding the number of people and household type. In the case of families to relocate, each card also contains information on the location of the previous housing, so that it can be demolished after the family's relocation. In the case of entrepreneurs, each card contains information about the type of company or business that will be established.

#### 4.4 Street Design

Decisions regarding the streets are taken by the Architect's Team together with the local administration and should serve the interests of the place and its surroundings. The Game "begins" with the main axes of access and connection between public space and buildings, as well as existing housing. Rules were set up, to determine when a street may be built; trying to describe what would be a natural evolution of urban growth. The street layout is predetermined by the Architect's Team but the sequence of construction is dependent on the house re-location sequence. The layout locates building blocks divided into segments. Each segment is available for new construction when it is freed from illegal construction and is served by a street. The design starts with an initial street built in a free space according to the defined layout.

#### 4.5 Rules for House Location

The decisions regarding the houses are taken by the families according to the profiles given in the Deck cards. The card establishes the housing program. Each house can be placed within the urban plan at any available location, regardless of typology as long as there is an available space in an already infrastructured area.

### 5. The Computer Implementation

The Game explained above and its implementation was developed in an academic context and published in (Chora, 2015) where detailed descriptions of the game rules and the experimental simulations can be found. The idea of a computer implementation had a twofold origin: (1) the implementation of the game in a computer platform had already been discussed in the dissertation but would have taken too much time to conclude within the master's timeframe; and (2) a web-based implementation had also been discussed as a possible interface for model developed during the dissertation (see conclusions section in (Chora, 2015)). Therefore, we settled a preliminary implementation in the context of a Parametric Design Course developed at the Faculty of Architecture in the University of Lisbon (FA-ULisbon).

## Game based social housing

The dissertation already pointed out that the concept could allow the development of unforeseen urban layouts by slightly changing the given rules, transforming the tested game producing only previously defined urban layouts, into a bottom-up type of plan that would more interestingly accommodate the complexity of the process.

Before starting the computer implementation we translated the verbal rules given in the dissertation into a set of formal rules in the form of shape grammars (Stiny and Gips 1972). The Game board was set in its initial state as the representation of the existing urban conditions (or set of initial shapes) from which the generation or simulation of a plan can start by recursively applying the rules. On a second stage, and envisioning the computer implementation, we translated the formal shape grammar rules into a parametric design structure maintaining however the topologic structure embedded in the grammar rules. The initial assumptions were similar to those in the physical board scenario in terms of sequence of events. Based upon the data collected on the families, a priority order was established, in different levels of approach. First, we divided the houses in an ok/not ok listing, according to their level of conservation. Thus, a set of 78 houses were deemed uninhabitable and the remaining 47 could in last resort, be rehabilitated and kept as part of the District. This established a first level of priority for sequencing the plan implementation. Second, the two listings were reordered according to the available area per person, as a way of establishing a resettlement priority criterion. Information on the family profile, such as household size, type and financial readiness was used to define the house program establishing the house type to be applied in the game. Third, they were separated based on the geographic location in regard to 'Operative Building Areas' determined in the plan or game board. This implementation implied that a set of guidelines was previously designed as a kind of predesign matrix that structured the layout of the plan.

The site was divided into Operative Areas that, in the rehousing process, can either be deemed as Demolition Areas, Potential Building Areas, Building Areas or Completed Areas. After the new house is built, the original house is cleared, freeing space for future expansion. Families gradually occupy the site and progressively, the process of expansion and rehousing advances, by releasing new blocks for reconstruction.

A Demolition Area contains houses with families in need of resettlement, and corresponds to a priority clearing area. There can only be one active Demolition Area and the order in which the families are rehoused is established considering the houses within the Demolition Area. After it is cleared of the old settlement, a Demolition Area becomes a Potential Building Area, ready to be infrastructured for Building. Building Areas already have the necessary infrastructure for the settlement of new houses and therefore can be occupied. The first Building Area is initially prepared to receive new houses using an urban void and hence initiating the rehousing process. Completed Areas have been completely transformed into the new urban plan and can no longer receive new families.

So, in sequence we have: Demolition Area → Potential Building Area → Building Area → Completed Area

The Game combines the selection (semantic attribution) of an existing house in a Demolition Area, which gives us the information required to make an addition (build) of a new house in a Building Area, thus making a consecutive subtraction (demolition) of the original house in order to create new Potential Building Areas and keep the rehousing process moving.

The shape grammar is structured in two parallel levels: (1) controls phasing through the sequence: Demolition Area → Potential Building Area → Building Area → Completed Area; (2) controls the house relocation sequence: Semantic Attribution → House Addition → House Subtraction. Rules of the first level basically determine where rules of the second level can be applied. In practical terms, the first level grammar, progressively transforms the existing situation into the finished urban plan by progressively opening Building Areas on the predesigned plan matrix. Only the sequence of implementation cannot be predetermined as well as the exact final shape of the plan. Rules of the second level are basically three: (R1) – Semantic Attribution – labels the existing houses using the referred information regarding level of conservation and family profile. This rule embeds the principle that there is a priority structure predefined by the selection criterion explained above. This rule is a description rule that changes the priority label and pre-existing profile (house conservation condition + family profile) into a description of a house program to be applied for that particular family in the application of the following rule. (R2) – House Addition – adds a house on a chosen location fit for a specific set of program descriptions. The matching conditions are defined by the description of house program defined in the previous rule. In practical terms the algorithm shows in the predesigned matrix which plots of land are available for the required program description. The selection of the plot is manual, corresponding to a choice of the player. The rule is therefore an addition rule that adds a house in an urban plot chosen from a set that fits the program. The manual action introduces the interaction of the player, i.e., the family choosing a location for their house. The addition rule ‘freezes’ the plot shape in the matrix and adds the house type. (R3) – Erases the original family house from the representation of the existing situation. This subtraction rule progressively frees space for transforming Demolition Areas into Potential Building Areas thus opening space for new plan implementations.

In the definition of a family house program, two conflicting criteria were taken: first, the number of persons composing the family which allows establishing a desirable program of housing spaces, and secondly, the economic profile of the family which determines whether the family has or not an economic condition able to maintain the rent values attributed to the larger housing types. In case, the family cannot support the rent, the program description shrinks to a type which sets the minimum conditions for the family but attributes a larger plot predicting possible house extensions very much in the same approach Aravena and Jacobelli propose in *Elemental housing plans* (2012).

The computer implementation was developed in the context of a Parametric Design course at FA-Ulissbom. The implementation resorts to a parametric design platform aggregating Rhinoceros, Grasshopper and Excel. The family profiles, comprising information given by the municipality with information collected by students on site, was assembled in Excel from which we could access each family’s profile in Grasshopper. To develop the game board we used CAD

## Game based social housing

cartography to support the initial representations from which the polygons representing the existing houses were isolated in a layer and associated with the data available in the Excel table using the Grasshopper interface. We also added a new layer of representation which represented the predesigned plan matrix.

The game interface joins Rhinoceros and Grasshopper interfaces. The program reads the family profile from the Excel table and the algorithm, following the criteria set above, establishes the priority sequence upon which the families play. Each house corresponds to a specific design iteration involving the following algorithms: (1) House linked to family profile. (2) Family profile generates housing program, meaning a particular house type for a required program. (3) The required program and respective house type highlight the available spaces in the predesigned matrix. (4) Family chooses where to place house (manual selection procedure). (5) Plot addition + House addition. (6) Erases original house (subtraction).

The game progresses recursively until it reaches a stabilized solution where at least all original houses in bad conservation conditions are replaced by new ones. Houses in acceptable conservation conditions can be kept in their original position with eventual additions. These decisions are set by the families and may produce reasonably different plan arrangements.

### 6. Discussion and Conclusion

The game implementation presented here is still work in progress. The obtained plan is till this point still a top-down design in the sense that the final arrangement is essentially defined by the predesign matrix developed by the architect. In several occasions the authors discussed the possibility of developing another grammar level to determine the street layout, however, the specific topographic conditions of the location as well as the constraints defined by the prioritization sequence created already too many difficulties for a full implementation of the game. Therefore, although we still envision the possibility of further developing a less deterministic solution, we found it more reasonable to start the first game implementations by following a set of predefinitions that would allow having some control on the generation of public spaces and essentially on the qualities of those spaces. In fact, a bottom-up approach would bring into play the complex issue of defining qualitative controlling mechanisms and specific criteria to define such control mechanisms. There are also still some open decisions regarding what to do in face of layouts obtained from situations where most houses in acceptable conservation conditions are preserved. In fact, this situation is being fine-tuned as implementation tests (or game plays) are done. Still, the option of having final arrangements automatized or simply manually adjusted is under discussion.

Finally, as a conclusive statement, the game, as developed to the present moment, is robust enough to be subjected to a real implementation in case the municipality finds this approach a manageable one. Specific problems arising from real situations could largely improve the theory and contribute to the development of a more democratic and open society.

### References

Aravena, A., Iacobelli A.: 2012, *Elemental, Incremental Housing and Participatory Design Manual*, Hatze Cantz Verlag, Ostfildern.

Chora, M I.: 2015, *Habitação incremental e decisão participada: uma metodologia para o Bairro do Barruncho*. FA. (Master Thesis)

Mayer, I., G. Bekebrede, Bilsen A., and Zhou Q.: 2009, 'Beyond SimCity: Urban Gaming and Multi-actor Systems'. In *Model Town. Using Urban Simulation in New Town Planning*: 168–181.

Shubik, M.: 1975, *Games for society, business and war; towards a theory of gaming*. New York, Elsevier, mentioned in Mayer, I., G. Bekebrede, A. Bilsen, and Q. Zhou. 2009, 'Beyond SimCity: Urban Gaming and Multi-actor Systems'. In *Model Town. Using Urban Simulation in New Town Planning*: 168–181.

Stiny, G., and Gips J.: 1972, "Shape Grammars and the Generative Specification of Painting and Sculpture": 1460–1465.

Tan, E.: 2009, *The Responsive City TReC*. <<http://www.theresponsivecity.org/>> (accessed 3 May 2016).

Venhuizen, H.: 2010, *Game Urbanism, Manual for Cultural Spatial Planning*. VALIZ, Amsterdam.



**Joaquim Reis**

*ISCTE-IUL*

*Lisbon, Portugal*

*Joaquim.Reis@iscte.pt*

**Abstract:** Origami is an ancient art of paper folding, existing since the invention of paper. Pure traditional origami consists on performing a series of folding operations on a square sheet of paper to assemble a final paper model. This paper is basically an introduction to origami and it is composed of a brief introduction and history of this ancient art followed by three essentially demonstrative sections. The first of these sections shows the basic folds, which are the essential steps used in origami making: the valley/mountain, pleat, crimp, reverse, sink, squash, swivel, rabbit ear and petal folds are shown. The second section shows some of the standard bases. Bases are essentially incomplete origami models, used as halfway baselines to produce different finished models: the kite, fish, bird, frog, cupboard, windmill, water bomb, square and blintz bases are shown. Finally, there is a third section showing some popular napkin origami models. A final conclusion with our intentions for future work will terminate the paper.

**Keywords:** *Origami history; Origami folds; Origami bases; Napkin origami.*

## 1. Introduction

Origami is an ancient art of paper folding. Pure traditional origami is based on assembling a bi or tri-dimensional static paper model, by performing a series of folding operations on a unique square sheet of paper.

There are variants of this pure art form. Different shapes of the initial sheet, like rectangular or other can be used. Different foldable materials, like cloth, metallic sheet, or other can be used. Cutting operations can be included, and can be dominant, this is known as *kirigami*. Multiple initial sheets can be folded, made to fit and assembled in one model, which is known as modular origami. The final goal can also be models that can move, fly or go through some kind of transformation, which is known as dynamic, or action, origami. Different fastening methods, like gluing, staples, *etc.*, can be used to assemble a complex sculpture (Temko, 2006).

Aesthetically speaking, models can either be authentic pieces of art, ranging from the figurative (flowers, animals, people, everyday objects) to the abstract (geometric objects, patterns, tessellations, *etc.*) or functional, useful, objects like boxes, cups, ash trays, structures, folded maps, *etc.*

## 2. A Brief History of Origami

Origami is an ancient art of paper folding which is believed to exist since the invention of paper. Paper was invented in 105 A.D. by a Chinese court official and was taken to Korea and

Japan in the sixth century by Buddhist monks. Arabs have taken contact with paper fabrication in Uzbekistan in the seventh century and brought it to West when they invaded Spain. Until the thirteenth century paper fabrication and use was progressively spread through European countries like Italy, France, England.

Apparently, there are two independent origami origins until the middle of the XIX century: one in Japan since the VII century and another in the Iberian Peninsula since the VIII century.

### 5.1 Classic Japanese origami

Origami is part of the Japanese culture and from the eighth century to the twelfth century (during the Heian period) was already taking significant part in ceremonies of the nobility. Origami was often a form of wrapping for ceremonies (Beech, 2005; Cantz, 2005). For example, there was a custom of the samurai warriors of exchanging wrapped gifts of good fortune, called *noshi*. Diplomas of Tea ceremony masters were closed by folding them in a manner as to remain secret and, once unfolded, they could not be folded again without leaving additional creases, *i.e.*, traces revealing the opening. There was also a kind of wrapping for bottles of sake. Also, in the celebrations of noble Shinto weddings, glass cups decorated with paper female and male butterflies, representing the bride and groom, were used.

From the fourteenth century to the sixteenth century (during the Muromachi period), with the popularization of paper, origami takes another ceremonial aspect in Japan, with different styles of origami used to distinguish different classes of samurai aristocrats. Later, during the centuries XVII to XIX (the Tokugawa period), which involved a flowering of Japanese culture and art, origami had a great diffusion. In this period a new type of origami appeared: the figurative, or recreational origami, which includes several known origami models, such as the bird, or grou (in Japanese, Orizuru) and what is now called the bird base (Beech, 2005; Cantz, 2005). Many representations of those origami can be seen engraved in wood or drawn in books since the eighteenth century. There was then already quite sophisticated origami, whose complexity made adults fascinated, more than children.

### 5.2 Classic European origami

In the eighth century the Moors invaded the Iberian Peninsula and brought paper and paper folding to Spain with them. Those people were excellent with mathematics and astronomy and, possibly, the theory behind folding paper was used as a support to the teaching of geometry principles. Although the Moors were later expelled from the Iberian Peninsula, the tradition of paper folding kept up to date and was notably practiced and documented (under the name of *coctología*) by the Spanish philosopher and poet Miguel Unamuno (XX century).

Traditional European classics are, for example, the *pajarita* (parrot) in Spain, the *cocotte* (chicken) in France and origami horses and riders of the nineteenth century kept today in German museums (in Nuremberg and Dresden). The German baptismal certificate of the sixteenth and seventeenth centuries is another example, which corresponds to what is now called the blintz base (Cantz, 2005).

## Origami: History, Folds, Bases and Napkins in the Art of Folding

The European classic origami is well documented in the context of children's education also. This was due to Friedrich Fröebel, a German educator who established the first kindergarten in the middle of the nineteenth century and included paper folding in the children's educational program (Cantz, 2005). Perhaps for this reason, in the modern West folding paper has been for long seen as little more than a hobby for school children, who amused themselves with birds, frogs, hats, water pumps, boats and darts (later planes) made of paper. However, more recently, many paper folding enthusiasts recognize the practice of origami as an intellectual challenge and an exercise in creativity.

### 5.3 Traditional and modern origami

According Koshiro Hatori, see (Cantz, 2005), Japanese and European paper folding remained independent until the middle of the nineteenth century, being quite different (*e.g.*, the classical European origami is based on creases angled mostly at 45 degrees, while the Japanese is typically at 22.5 degrees). Then, there was an interchange movement giving birth to a mixture between European and Japanese origami, yielding a repertoire that evolved and formed the core of traditional origami.

Also according Hatori, from the middle of the twentieth century there occurred a second interchange movement that popularized the art of origami and gave rise to the so-called Modern origami. This is characterized by authoring, *i.e.*, recognizing the intellectual property of origami creators (this did not happen with traditional origami, where the author is anonymous), by viewing origami as an intellectual challenge, by the publication of origami works of European, American and Japanese in English and Japanese, by the foundation of organizations focused on origami (for example, the British Origami Society, founded in 1967) and by the standardization of notation used in origami representation diagrams (created by Japanese engineer Akira Yoshizawa, one of the leaders of the modern creative origami, in the 1950s and 1960s and the introducer of curved folds using damp paper).

### 5.4 Mathematic and computational origami

The modern design method of origami depended on some existing origami bases. A base (*e.g.*, the bird base, the frog base, the blintz base) is an origami an intermediate phase of the folding sequence that can serve as a starting point to produce certain finished origami models.

From the 1980s on, starting with independent work of Jun Maekawa and Peter Engel, who studied the geometric aspects of the foundations, a process of inventing new bases was discovered, paving the way for the composition of complex origami models. Essentially, the method consists in the rearrangement of crease patterns (triangles, rectangles) on the sheet of a disassembled existing base to obtain a new base, which can yield different origami models. This led to an engineering-like process, in which new models can be designed before performing the folds that produce them. The mathematical methods behind the process have been further developed and resulted in computational algorithms which allow automation of the process (an example of this is the program TreeMaker, of Robert Lang, one of the scientists involved in the

mathematical origami trend) (Cantz, 2005; Lang, 2003; Demaine and O'Rourke, 2007). The practical application of folding principles opened the door to the engineering of many kinds of self-assembly, self-transforming artifacts, not just decorative but useful and functional ones as well (Lang, 2003; Hull, 2002).

### 3. Basic Folds

A fold is the basic step used in origami making. In Figure 3 we represent the basic rectilinear fold, called valley or mountain fold depending on the result being hiding or showing the initially observable paper face.

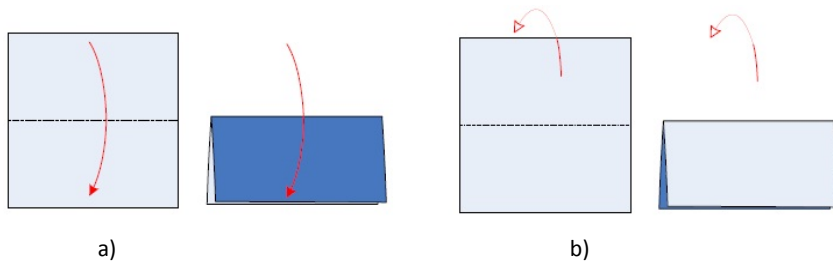

Figure 3 – Valley (a) and mountain (b) folds.

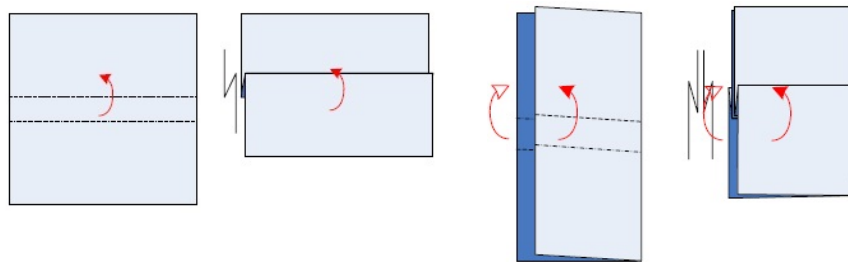

Figure 4- A crimp fold.

Figure 5- Pleat fold.

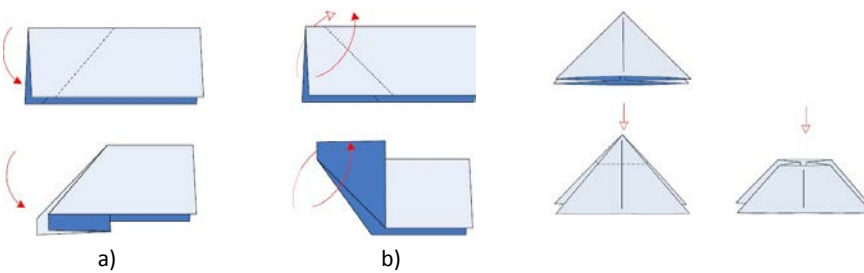

Figure 6- Inside (a) and outside (b) reverse folds

Figure 8- Sink fold.

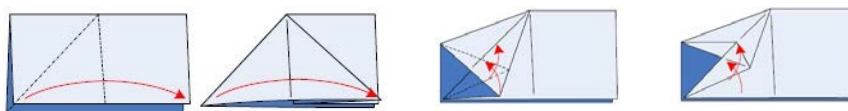

Figure 7- Squash fold.

Figure 9- Swivel fold.

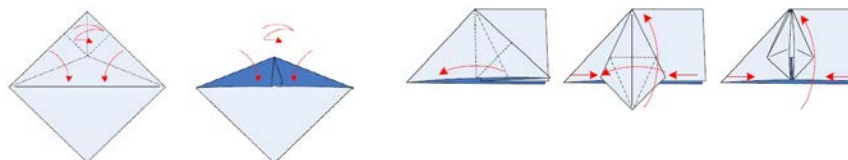

Figure 10- Rabbit ear fold.

Figure 11- Petal fold.

## Origami: History, Folds, Bases and Napkins in the Art of Folding

From

Figure 5 to Figure 10 we show how to obtain instances of other typical folds. These are used extensively as basic steps in many origami bases and finished models, see (Lang, 2003). Examples of the pleat, the crimp, the reverse, the sink, the squash, the swivel, the rabbit ear and the petal folds are shown. Animations of these will be shown in the paper presentation.

### 4. Some Standard Origami Bases

Bases are essentially incomplete origami models, used as halfway baselines to produce different finished models. In this section we show some of the standard bases.

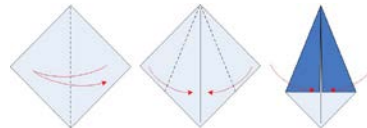

Figure 12- The kite base.

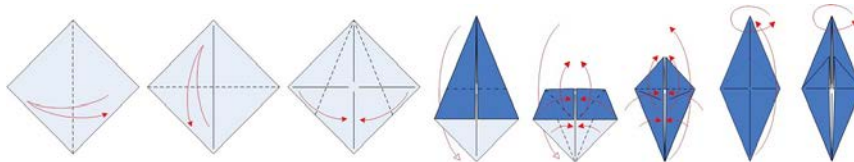

Figure 13- The fish base.

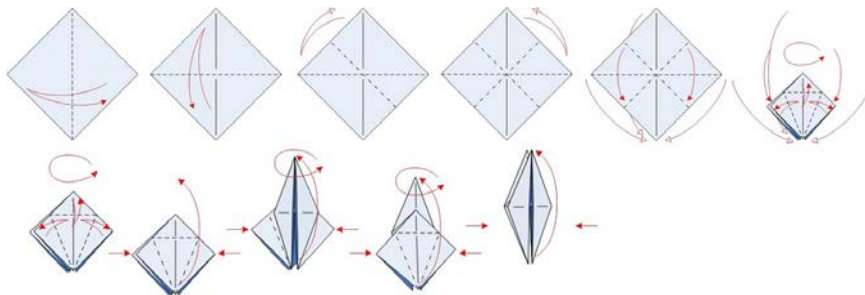

Figure 14- The bird base.

From Figure 12 to Figure 20 we show how to obtain the kite, the fish, the bird, the frog, the cupboard, the windmill, the water bomb, the square and the blintz bases. Animations of these will be shown in the paper presentation.

As pointed in (Lang, 2003), there is an hierarchy in the bases presented. For instance, the fish base includes the kite base at its beginning; the windmill base also includes the cupboard base.

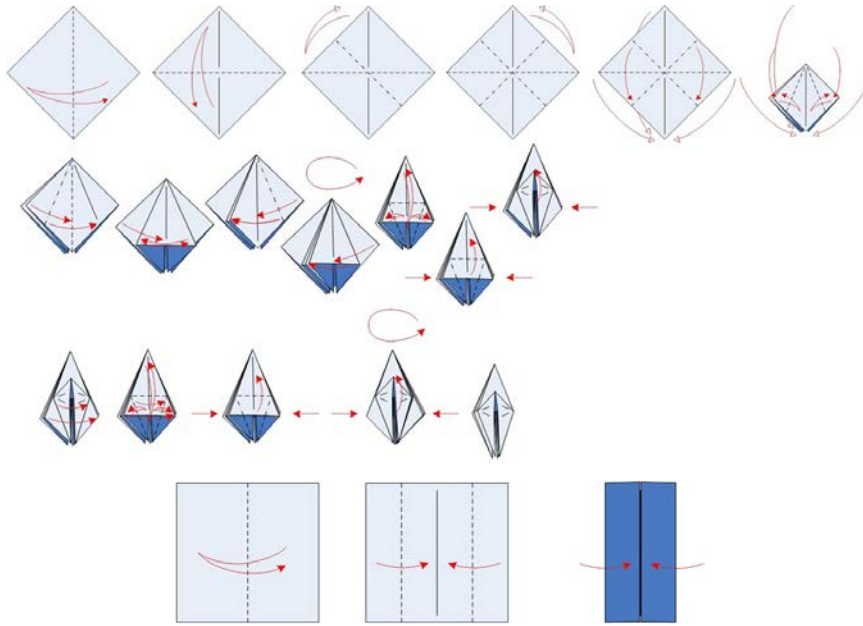

Figure 16- The cupboard base.

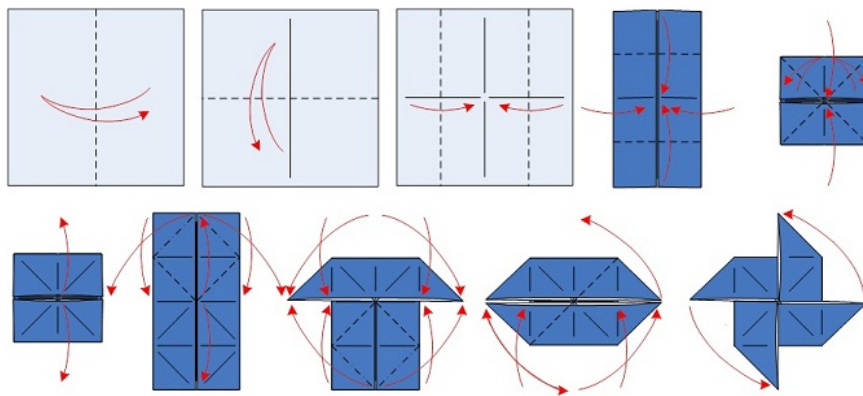

Figure 17- The windmill base.

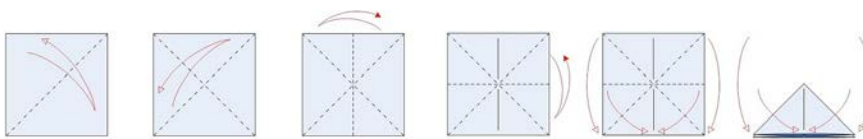

Figure 18- The water bomb base.

## Origami: History, Folds, Bases and Napkins in the Art of Folding

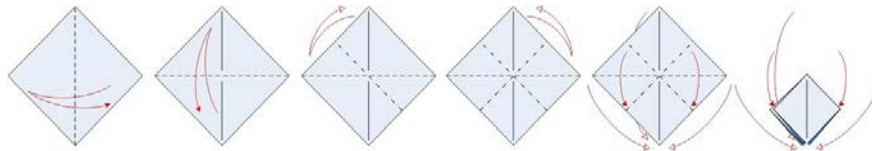

Figure 19- The square base.

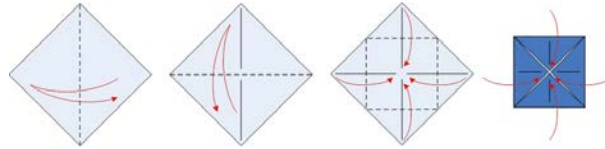

Figure 20- The blintz base.

### 5. Some Popular Napkin Origami Models

In this section we show some napkin origami models (both cloth and paper napkin).



Figure 21- Some napkin origami models (from left to right and top to bottom): a candle, a flame, a shell, a fan, a Japanese folding, a leaf, a boot, a rose (paper), the bishop's hat, fire in a glass and an Easter bunny.

These models were produced according to (Beech, 2005). Videos will be shown in the paper presentation.

Napkin origami is a popular origami variant not rarely seen on hotel and restaurant dining tables. Exotic models (e.g., giraffes, palm trees) can also be seen on top of hotel beds made with towels or linen sheets.



## 6. Conclusion and Future Work

In this paper we gave a brief introduction to origami and its history, presented the basic folds and some of the standard bases and showed some popular napkin origami models.

Our goals for future work are to study and explore origami using a more scientific approach, with the formalization of folding mathematics and the computational representation and modeling of origami (including the challenge of the flexible material origami, *e.g.*, cloth, napkin), following work being done in the scientific community, see for instance (Hull, 2002; Lang, 2003; Demaine and O'Rourke, 2007; Ida and Takahashi, 2009).

## References

- Beech, R.: 2005, *Origami, the Complete Guide to the Art of Paperfolding*, Lorenz Books.
- Beech, R.: 2005, *The Practical Guide to Napkins and Napkin Folding*, Hermes House/Anness Publishing Ltd.
- Cantz, H.: 2005, *Masters of Origami at Hangar-7, the Art of paper Folding*, Verlag.
- Demaine, E. and O'Rourke, J.: 2007, *Geometric Folding Algorithms: Linkages, Origami, Polyhedra*; Cambridge University Press.
- Hull, T. (editor): 2002, *Origami 3: Third International Meeting of Origami Science, Mathematics, and Education*, AK Peters, Ltd.
- Ida, T. and Takahashi, H.: 2009, *Origami Fold as Algebraic Graph Rewriting*, *Journal of Symbolic Computation*, Vol.45, 4, 393-413.
- Lang, R.: 2003, *Origami Design Secrets, Mathematical Methods for an Ancient Art*, A K Peters Ltd.
- Temko, F.: 2006, *Origami and Kirigami, 75 Fun-to-Do Projects*, Dover Publications.

## Cork: New Uses in Architecture

**Cristina Verissimo**

*Dalhousie University*

*Halifax, Canada*

*cristina.verissimo@dal.ca*

**Abstract:** Cork usage is one of the most promising trends in sustainable development, due to its unique natural properties, exceptionally good environmental qualities and its high potential to incorporate innovative technology. Today amongst other uses we see cork used as a textile for clothing, in automobile parts, and as a thermal shield in space crafts. This diversity is crucial for the sector's feasibility. However, there is still a lack of information and diffusion within the engineering and architecture sectors; stakeholders lack awareness to use and select cork materials for construction, compared with other competing products. This research plans to explore future cork industry developments, cork recycling and new cork-based materials which are still in various stages of development with enormous potential for construction. We aim to test or adapt them to be used in construction, hoping that in the future there will be greater application in architecture and eventually will contribute to greater sustainability in the construction business as well as the cork sector. This research started two years ago providing an environment for researchers and architects as well as those in the industry and other interested parties to meet and develop ideas and experiments using cork.

**Keywords:** *Cork; Sustainable Material; Materials Engineers Design; Architecture; Culture*

### **1. Introduction**

This research will create greater bring awareness of the potentialities of cork as sustainable material, and seek possible new uses of cork materials in architecture. Cork is a natural, recyclable, renewable and non-toxic resource, with strong impact in Mediterranean culture and ecosystems for centuries. Recent developments in cork research demonstrate that its application goes far beyond the classical cork-wine cultural relationship that is globally recognized.

### **2. Landscape and Culture**

Cork is a natural, recyclable and renewable material harvested from the living bark of the Cork Oak, *Quercus Suber L.* Though the Cork Oak can flourish in many climates, the conditions that favour commercial use lie in a fairly narrow swath that cuts through Western Europe and Northern Africa along the Mediterranean coast. Cork Oak forests are an agro-silvo-pastoral ecosystem, built by humans and preserved by control of shrubs and using natural resources (Potes, J. & Babo, H. 2003). They are maintained through the persistence, hard work and passion of generations that through centuries planted Cork Oak trees for their grandchildren to profit from

its eventual harvesting. This long span generational inheritance helped to reinforce and broaden the family links and values, so common in the Mediterranean.



Figure 22 to 3: agro-silvo-pastoral ecosystem

The maintenance of the cork forests helps to prevent the advance of desertification, improve water penetration into the soil and hydrological regulation, and promote soil conservation, while being the perfect habitat for many animal and vegetables species. Consequently, these forests promote biodiversity (Pereira, 2007; Gil, 2011). A cork oak produces about four times more cork if it is harvested, with healthy growth benefits to the tree. It also increases the fixation of CO<sub>2</sub> and enables the tree to flourish without the intervention of herbicides, fertilizers and irrigation. (Gil, 2010).

### 3. Cork and History

“Wine and cork were born and come together in the Mediterranean” (Santos, C. O. & Amorim, A., 2008). The use of cork is ancient, especially along the Mediterranean with its use from daily life objects to architecture. Existing buildings such as the Convent of the Capuchos of the XVI century, Sintra, Portugal, still shows how cork was used as a finishing and outdoor material for comfort (Muchagato J.; Oliveira Martins A. 2013). Cork was an early product in a global market due to Portuguese and Spanish empires of the XVI century (Santos, C.O., 2000). With the invention of champagne by Dom Perignon in the XVII century, the use of cork stoppers became an important trade business (Santos, C.O., 2000). The XIX century marked the establishment of a global cork industry. The USA was one of the most important markets for cork (Pestana, M. e Tinoco, I. 2008).



Figure 4 - Use of Cork in history



Figure 5 – Capuchos Convent, Portugal  
by JBond



Figure 6 – Monsaraz  
door, Portugal

## Cork: New Uses in Architecture

### 4. Material Properties and Uses

The unique properties of cork are derived from the structure and chemical composition of the inner cells. On average, there are around 40 million cells in each cubic centimetre of cork. Consequently cork: is very light, impermeable to liquids and gases, elastic and compressible, thermal effective, a sound insulator, resilient, high temperature resistant, fire retardant, hypoallergenic, shock absorbent, soft to the touch, and warm feeling. (Gil 2007). Cork is very versatile and adopts different technological transformation processes, giving rise to several products, which can be used in different applications. New demands for cork give rise to new technologies that can replace traditional methods of boiling the cork, through a microwave process that maintains cork qualities but expands the material's capacity to three times more than its original size. Meanwhile, cork products for the construction industry are most suitable for sustainable and efficient energy construction, given its mentioned ecological characteristics. In addition, these products contribute to general comfort and indoor air quality (Gil, 2007). This gives an opportunity in architecture for the use of cork as a primary material as in the past. In the last decade some examples of the use of cork have emerged, such as: Portugal Pavilion for Expo 2000 Hannover exhibition, Serpentine Pavilion, London, 2012 or Portugal Pavilion Shanghai Expo



Figure 7 – Alvaro Siza, [Eduardo Souto Moura](#), Portugal Pavilion for Hannover, | 2000



Figure 8 - Herzog & de Meuron and Ai Weiwei, Serpentine Gallery Pavilion 2012



Figure 9 – Carlos Couto, Portugal Pavilion Shanghai, 2010

2010. Other less-known examples have emerged in the Iberia Peninsula recently, which have not yet achieved international relevance. (Chebao F., 2011).

### 5. Research and Methodology

This research started July 2014, with the organization of an international workshop in Lisbon, focused on the use of cork as a material in architecture. It provided an environment for researchers and architects as well as those in the industry and other interested parties to meet and develop ideas and experiments using cork. The Workshop is to be held annually (in July) proposing different challenges every year. In the future, it will be a platform for the internationalization of the use of cork as a building envelope material. It runs in a three-year cycle, organized by themes, according to the type of materials/prototypes that are going to be tested or developed during each workshop.

For Workshop One: Year One, July 2014, the topic was the use of Natural Cork – Tradition. The objectives developed were: 1 - Gain an appreciation and understanding of Cork as a material. 2- Understand traditional methods in the use of Cork and learn from that experience. 3 – Conduct

explorations with natural cork or products using only natural cork, to understand its potentialities and possible applications as a building envelope. Extended research was conducted into recycling of residuals of natural cork produced by cork stopper manufacture. Since cork is a material with enormous potentialities of application, in order to reinforce the methodology we divided the research into three main subjects for the workshops: cork as a membrane, cork as a finishing and cork as self-supporting material. These are three examples, of the over 20 experiences developed from last year:



Figure 10 – Cork used as a membrane



Figure 11 – Cork used as a finishing material



Figure 12 – Cork used as a self-supporting material

These are three examples, of the over 20 experiences developed: in figure 10, cork was used as a membrane. The incorporation of recycled cork stoppers gives a surprising structure to the fabric and added thermal insulation. In figure 11, black cork agglomerated was transformed through CAD-CAM process into a tile that was applied as a finishing material to a curved surface, with thermal and acoustic benefits. In figure 12 a dome was assembled using natural cork for joints and cork natural black agglomerated. This dome can be folded and transported due to its lightweight.

This workshop had around 30 participants from Portugal, other European countries and Canada and several local and international universities joined the event. We also had the participation and contribution of well recognized researchers in cork materials, engineering and biology. The final exhibition was opened to the public in the University of Lisbon, Faculty of Architecture from July to September, 2014. [<https://www.facebook.com/corkworkshop>, accessed on 07Feb2015 21:07]. In January 2015, it was reopened as the main exhibition for the research accreditation visit to the same University.

For Workshop Two: Year Two, July 2015, the topic was the use of Cork Composite – Industry. On the last decades there has been an important effort, from the industry, to develop a number of new derivative products of cork incorporating new technologies applied to traditional products. The objective of this research is to understand how some of these materials or products will be adapted for use in construction.

Therefore the research concentrated: 1 - to know the industrial cork processing chain and the composite cork products. 2 - Selection and characterization of cork products and their use changes, i.e. with aging and weathering, with a selection of performance-related indicators. 3 - Conduct experiences in the Workshop involving the industry, overcoming potentialities of their materials. Extended research was conducted into recycling of residuals of composite cork



## Cork: New Uses in Architecture

produced by cork industry. It was used the same methodology as in previous year: cork as a membrane, cork as a finishing and cork as self-supporting material.



Figure 13 – Cork used as a membrane

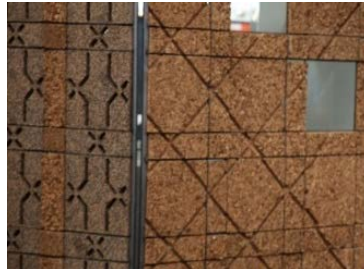

Figure 14 – Cork used as a finishing material



Figure 15 – Cork used as a self-supporting material

These are three examples, of the over 20 experiences developed: in figure 13, cork was used as a membrane. The double layer triangle pattern cork fabric is glue to natural fibres that work as a connector element for the pattern. The interior of the triangles is filled with cork granules adding thermal insulation. As alternative the triangles can be insufflating with air. In figure 14, Rubber Cork Composite and Cork Resins composite materials, creating a tile through CAD-CAM process. A pattern was carved in the titles and flied with natural resin for transparency. The tiles were attached, as a finishing material, to metal structure, with thermal and acoustic benefits. In figure 15 a small pavilion was assembled using laminated wood and cork for surfaces and black rubber cork for joints. The pavilion was assemble without any metal joints.

This workshop had around 32 participants from Portugal, other European countries, Canada and Japan. Several Portuguese universities joined the event. We also had the participation and contribution of well recognized researchers in cork materials, engineering and biology. The final exhibition was opened to the public in the University of Lisbon, Faculty of Architecture in August, 2015.

[<https://www.facebook.com/corkworkshop>, accessed on 287Feb2016 16:51]. From November 30th to December 4th 2015, the exhibition was presented at Feira do Montado de Portel. In February 16th it will open in Observatorio da Cortiça in Coruche.

For Workshop Three: Year Three, July 2016, the topic will be New Materials - Future Technologies. On the last decades there has been an important awareness that architects have to start looking for natural and sustainable materials for building construction. Therefore the research will concentrate: 1 - Understand current architectural practices and foreseeing their future needs. 2 - Selection of new materials and technologies that can, in the future, bring new possibilities of use in architecture and product design. 3 - Understand how research and industry can work together to develop strategies that can be strategic to the applications in architecture.

## Conclusions

This research will create greater awareness of the potentialities of cork as sustainable material, and seek possible new uses of cork materials in architecture. As a result it may

contribute to greater sustainability in the construction business and also in the cork sector. From last year initiative and results there is a clear interest by the different Universities, institutions and Industry to continue to support this research. It has been proved it is a wonderful platform to reach young generations of future architects and designers for the opportunities of the use of cork in architecture.

## References

- Pereira H.,2007. "Cork: Biology, Production and Uses". Amsterdam: Elsevier: 26-29, 33 -53.
- Gil, L., 2007 "Cork as a Building Material. Technical Manual". Santa Maria de Lamas: APCOR.
- Gil L. 2010. "A cortiça, o ambiente e a sustentabilidade" (in Portuguese). Biol. Soc. 10, 13–15
- Gil L. 2011. "Environmental, sustainability and ecological aspects of cork products for building". Sci. Technol. Mater. 23, 87–90
- Potes, J. & Babo, H. 2003. "Montado" an old system in the new millennium" African Journal of Range & Forage Science, 20 (2): 131-146
- Santos, C.O., 2000 (in Portuguese) "O Livro da Cortiça". Ed. Carlos Oliveira Santos/Diglivros. (65-72)
- Santos, C. O. & Amorim, A., 2008, "Clusters United by Nature: the World of Wine and Cork", Amorim Group, 29-32
- Muchagato J.; Oliveira Martins A., 2013 "Convento of the Capuchos", Parques de Sintra and Scala Arts & Heritage Publishers,
- Pestana, M. e Tinoco, I., 2008 (in Portuguese) "A Indústria e o Comércio da Cortiça em Portugal durante o Século XX", 1-5
- Gil L., Moiteiro C. (2003). "Cork" in Ullmann's Encyclopedia of Chemical Technology", 6th Edn. Germany: Wiley-VCH Verlag
- Chebao, F. 2011, (in Portuguese) "Cortiça e Arquitetura". Euronatura, 51-81



# Two Problems: Two Concepts: Two Grammars

*Grammatical exercises to inspire problem solving in the design studio*

**Mohamed S. Ibrahim**

*Beirut Arab University*

<sup>1</sup>*Alexandria University*

*Alexandria, Egypt*

*M.ibrahim@bau.edu.lb*

**Abstract:** The research is motivated by the challenge of facilitating the introduction of different design strategies in studio using the theoretical potentials and determinacy of computational design models. Two experiments are conducted combining conventional studio exercises with specific models of design computation in order to build connections between analysis and design, thinking and making, involving students directly in given examples rather than direct instruction to transform formal design exploration into a more purposeful activity.

*Keywords: Project-based Learning; Shape grammars; Pedagogical Grammars.*

## 1. Introduction

The goal of the early efforts of design computation was to predict the unpredictability of design. Researchers aimed at reaching for rigorous or more precise models of design reasoning that are based on a well structured analytic work instead of only relying on very soft traditional strategies like intuition, architect's belief and the use of formal knowledge.

Addressing the vagueness and Indeterminacy of the design process on the other hand outstood and motivated the search from another perspective, the design education one. Design Tutors tried to effectively transmit a comprehensive codex of design knowledge, including procedural knowledge about how to design and how to reason about designing. This consequently helped developing useful models that interpret design and problem based reasoning in a very comprehensive and understandable way.

This paper is motivated by the challenge of facilitating the introduction of different design strategies in studio using the theoretical potentials and determinacy of computational design models.

## 2. Design, Students and Computation

The architecture discipline is somehow different, unique and complex, part of the complexity of the profession is that it is torn between practice and theory, art and technology, and between autonomy and heteronomy (Gutman 1977) . Unlike other problems as well, design

---

<sup>1</sup> Dr. Mohamed S. Ibrahim is a full time assistant professor at Alexandria university, currently on secondment to teach at Beirut Arab university

problems are “ill-structured”. They often do not contain enough information to be solved rationally (Kalay 2004), and they confront students with uncertainties that must be dealt with. Solving design problem opposed the way students used to reflect and think under their pre-university pedagogical system that was mainly well structured, lending them to memorizations and following clear instructions. Confusion occurs, as students are not yet accustomed to solving problems without a concrete methodology or clear instructions with guaranteed results to follow.

A truthful statement about computer and problem recognition was provided by Knuth (1974): “A person does not really understand something until he can teach it to a computer and express it as algorithm “. The recognition of the design problem begins with analysis, and computers are superb analytical engines (Kalay 2004), they can follow a line of reasoning to its logical conclusion. Unlike Artists, Architects do not just rely on intuition and creativity, without the use of rational processes; they deal with equal measures with externally imposed constraints that rely on both rational/ logical/ analytical and imaginative/ creative/ synthetic in order to produce relevant solutions to architectural problems. It is therefore expected that computational models of problem analysis might provide methods to uncover the roots of a problem and indicate a course of actions that will lead to the generation of possibly successful solutions.

The research here combines conventional studio exercises with specific models of design computation to build connections between analysis and design, thinking and making, involving students directly in given examples rather than direct instruction to transform formal design exploration into a more purposeful activity.

### **3. The problems: The applications context**

The implemented computational models are loosely based on the concept of grammatical design and shape grammars. Two grammatical concepts are applied, highlighting the conflict between free formal exploration and constraints driven designs, an often confusing activity that resonates between creative imagination and rational thinking.

The specific aim of each exercise complies with the intended learning outcomes of its pedagogical stage, and the research reviews its application during the studio work of almost four academic years of design and grammar teaching. The concepts are applied and supported by selected examples from the author’s work with students in both:

***The Beginning design studio*** : design exercises and workshops that took place in four universities from three different countries (Strathclyde University, Glasgow; Beirut Arab University, Beirut; Alexandria University, Alexandria; Cairo University, Cairo). These exercises and workshops were conducted with objectives specially tailored to fit with the design studio ILOs.

***Shape Grammars course***: Unlike the beginning studio, this pedagogical experience is in a more specific subject: introduction to shape grammar course (Cairo University, Egypt; Beirut Arab University, Lebanon). The course was originally planned to develop the students’ generic and analytical capacities .the author was therefore able to conduct more grammatical experiments, analytical and synthetic projects, enriching the teaching experience with different category of focused examples.

## Two problems: two concepts: two grammars

### 4. Grammar One: The Pushchair

#### 4.1 The Original Grammar: the concept

The traditional pushchair is composed of two main elements: Seating zone and handling device. The analysis of pushchairs reveals a core element (the Chassis) that is used for the beginning of the design generation. All other design elements are analyzed according to its relation and connection to the chassis (figure 1).

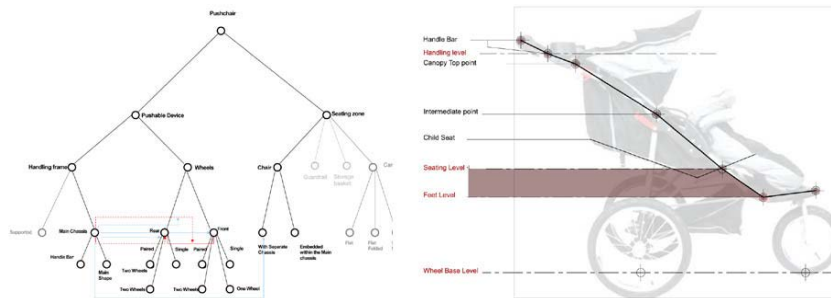

Figure 1. the product syntax tree and the common design element

The shape of the common Lightweight chassis contains seven points (figure 2) that has the same matches in almost all pushchairs types.

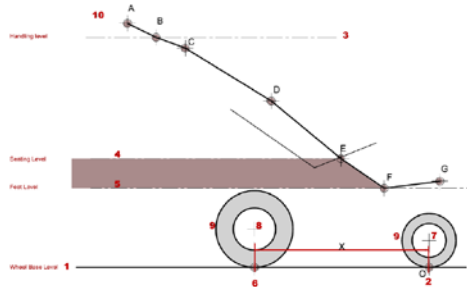

Figure 2. the allocation of the seven points alongside the common Chassis

The key elements of the brand are extracted and categorized. The grammar begins by defining each of the seven points location. Connected points draw the chassis profile; addition rules generate all other related sub- elements in three steps (figure 3): profile creation, feature refinement and final adjustment.

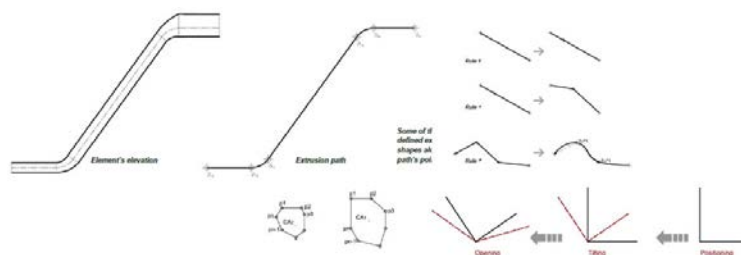

Figure 3. concept of the three steps of : Creation (loft), refinement and adjustment

All elements are then connected to the lightweight chassis (figure 4), they final layout is finally adjusted.

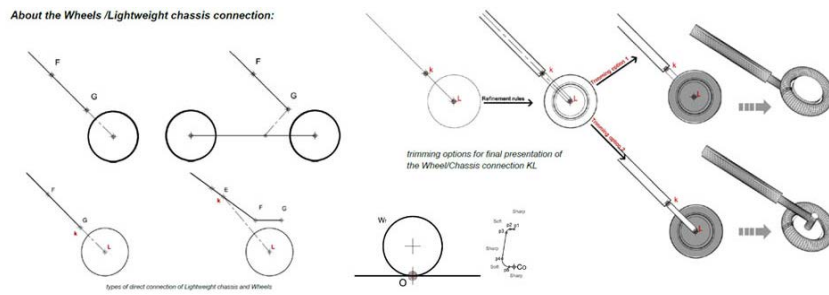

Figure 4. The conceptual generation of the front wheel following the previous three steps

## 4.2 The Studio Version

The studio version of the grammar begins with a preliminary layout for the main Design profile structure. Each element is generated separately, connected to the whole and the generated layout is then evaluated and modified accordingly. The design problem analysis begin by a breakdown of the problem (figure 5), searching for the common core for all designs in a language; this core may be either an element or a space. When identified, the organization of other elements/spaces around it is then analyzed to find the relation and the design is generated reversibly.

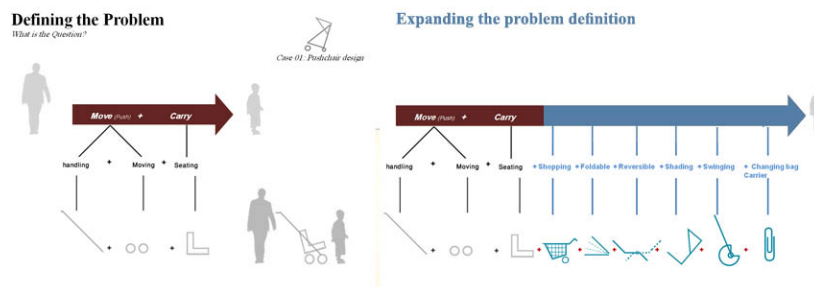

Figure 5. part of the problem definition presentation in the studio

The theme is applied to induce rational thinking with formal non-architectural subjects in a playful constructive manner. The selected designs are those who have common cores and most possibly generated by additive strategy. A Horse Carriage (Arabian "Hantour") (figure 6), Vehicle and gadget designs (figures 8 and 9) were introduced as themes for this model within the design studio, and the most architectural-related exercise was "a student Cubicle" (figure 7) (a multi-functional workspace).

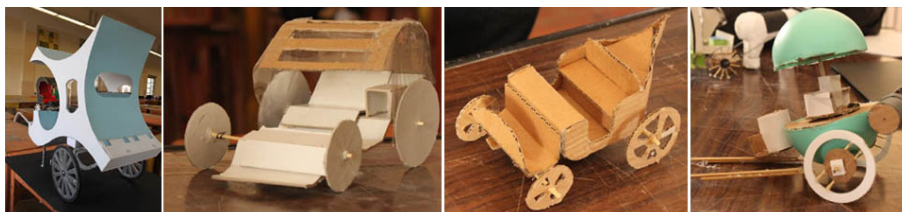

Figure 6. Vehicle design: main Chassis and elements generated (Students: Alexandria University)

## Two problems: two concepts: two grammars

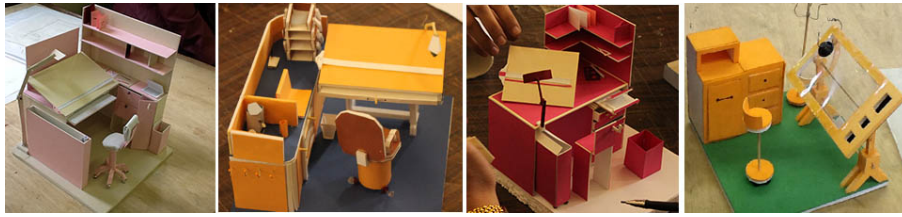

Figure 7. Cubical Design: Main frame and workspace and other elements attached then adjusted (Students: Alexandria University)

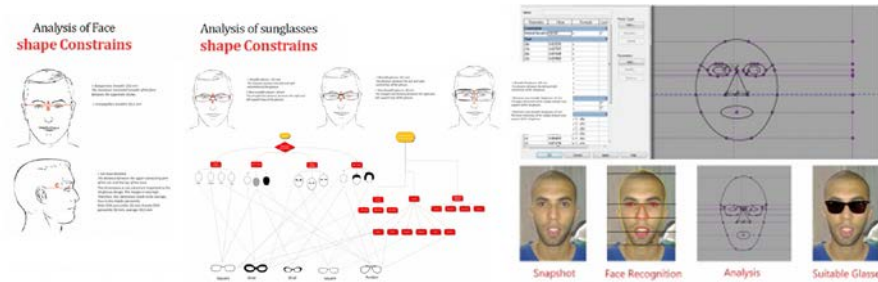

Figure 8. Rayban Sunglasses Grammar: Face layout identification then allocation of main features followed by the sunglass layout generation (Students: Cairo University)

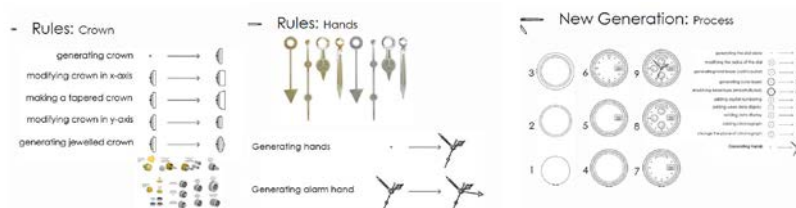

Figure 9. Rolex Grammar: the application begins with the generation of the outer bezel, the design key elements are added in relation to its perimeter and centre (Students: Alexandria University)

## 5. Grammar Two: Meier's Residential Facades

### 5.1 The Original Grammar: The Concept

The grammar is based on the subdivision of a rectangle with number of vertical and horizontal references to snap the subdivision on. It was devised upon the analysis of some of Richard Meier's houses elevations and structured into three stages:

- 1- Layout rules: subdivision rules that draw much of the elevation layout in space.

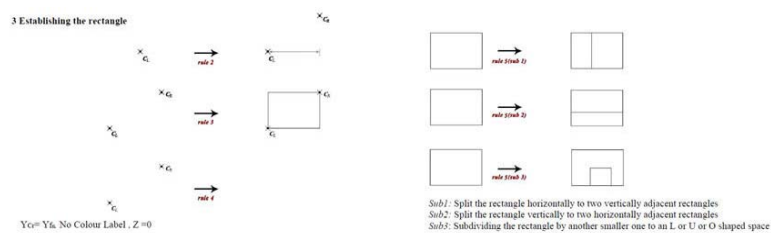

Figure 10. part of layout rules

2- Language rules: rules that carry most of Meier's façade design common features.

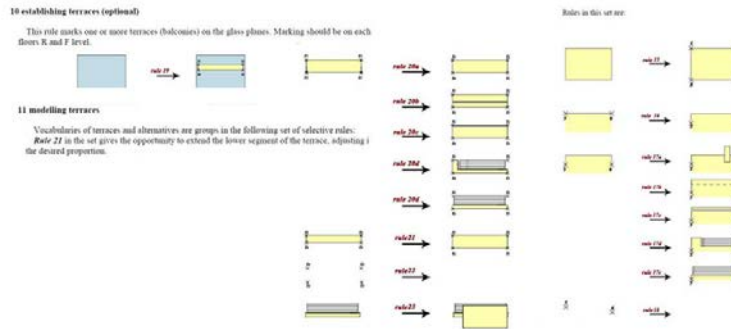

Figure 11. part of the language/articulation rules for terrace generation

3- Refinement rules (including parametric modifications)

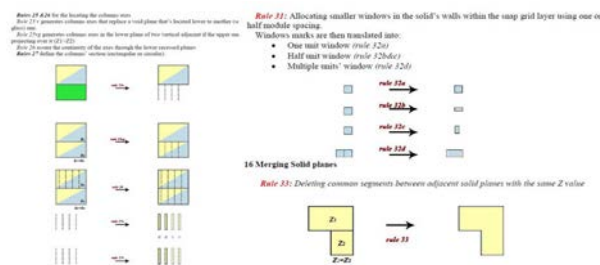

Figure 12. part of the refinement rules



Figure 13. using the grammar for generating RACHOFSKY house facade

5.2 The Studio Version

A visual reasoning experiment demonstrated using a simple subdivision grammar (figure 14) that connects rational and imaginative thinking during the early design exploration. Constrains (like function) are related to formal attributes of shapes, Design explorations are built up in a Froebel /reverse Froebel blocks manner.

## Two problems: two concepts: two grammars

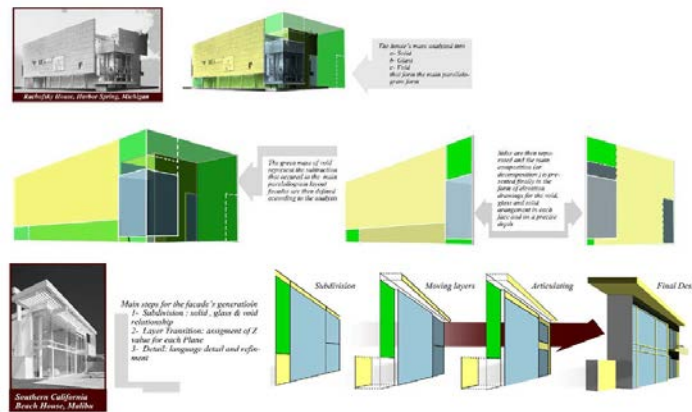

Figure 14.steps of applying the grammar in class: Subdivision, labelling, moving layers and articulation

Constraints like human scale, legislations, structure .etc, all are introduced in the conceptual example as references (labels) (figure 15) to guide the subdivision and avoid the defragmentation of the designed subject. The concept highlights the way design problems are solved by rendering constraints visible enough to relate formal exploration to, in order to generate meaningful design compositions.

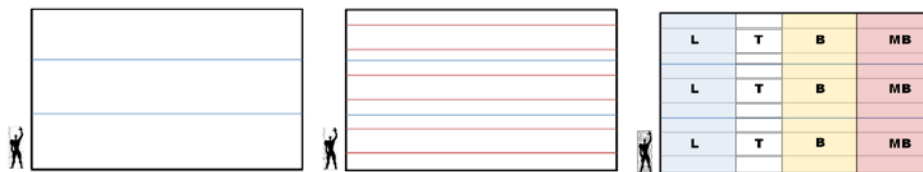

Figure 15.constraints introduced in design as references to snap the subdivision on.

The early application of this methodology was a straight forward example following the subdivision grammar (figure 16). Recent applications include an attempt to relate functional requirement to formal attributes of shapes during the composition of an elementary school (figure 17). Another emerged methodology is used to relate client traits and needs into design elements (Containers boxes) as architectural concerns while designing a house for a creative (figures 18).

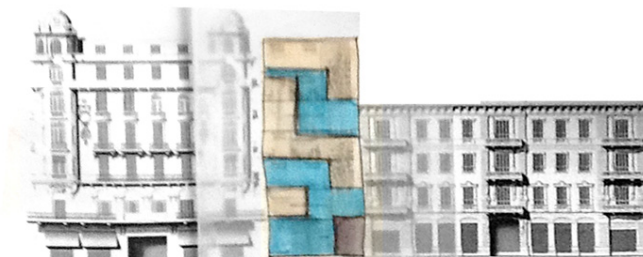

Figure 16.early example of the direct application of the methodology (Strathclyde University, Glasgow)



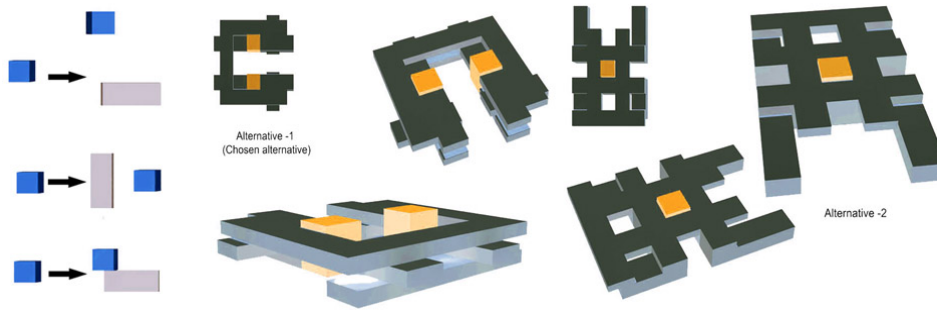

Figure 17. relating functional requirements to physical characteristics of shapes in elementary school design (Cairo University, Egypt)

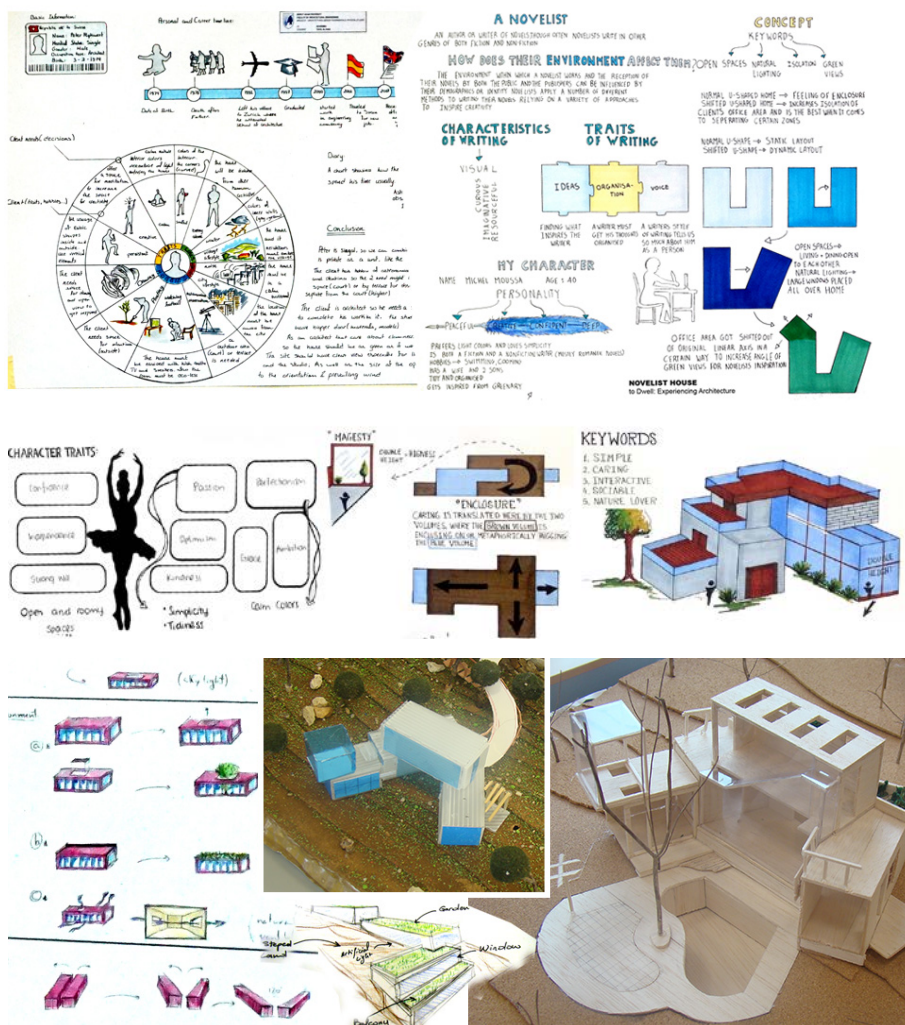

Figure 18. students examples, trying to render character traits and typological concerns as architectural values (references) to relate formal exploration to. (BAU, Lebanon)

## Two problems: two concepts: two grammars

### 6. Observations and Concluding remarks

Creativity, intelligence, guesswork, and intuition, qualities typically associated with the setting of the grammars are the same qualities required for problem solving ubiquitous in design studios. Using the analytical/synthetic grammar model as teaching aid promotes visual curiosity, excites the creation as well as the analytical process, increases data delivery and challenges understanding.

The applications show that by defining and using the idea of grammar in its most general terms, students were empowered to reconsider the process of design thinking and problem solving. More grammatical exercises could be conducted in the studio with great potentials, using metaphors of grammar that fame different problem solving strategies into its core structural components.

One final key concern is that potentials of the implemented grammar to develop design related skills increase with open and less determined models.

### Acknowledgements

The experiments could not have been conducted without the help of numerous colleagues, students, researchers involved in various aspects of design teaching.

Foremost, I wish to acknowledge the help of and thank to Prof. Scot Chase for his guidance during the two conceptual grammars development at Strathclyde University; Kathy Li for the early studio implementation; Prof. Sherine Wahba for the opportunity to apply the methodologies with advanced Cairo university students; Prof. Inas Hamdy and Prof. Mohamed Hanafi for their generous support with Alexandria university beginners; Dr. Baher Farahat and Dr. Ossama Omar for their help with Beirut Arab University First year studio and finally my talented and creative students in all mentioned institutions.

### References

- Gutman, R. (1977). "Architecture, The Entrepreneurial Profession." *Progressive Architecture* 58(5): 55-58.
- Kalay, Y. E. (2004). *Architecture's new media: Principles, theories, and methods of computer-aided design*, The MIT Press.
- Knuth, D. E. (1974). "Computer science and its relation to mathematics." *American Mathematical Monthly*: 323-343.

## Modular Structures:

### *A Kinetic Module Based on a Resch's Tessellation*

**Alessio Mazzucchi**

*MAP Gamsau, UMR 3495 CNRS/MCC,*

*Marseille, France*

*mazzucchi.alessio@outlook.com*

**Abstract:** In the last decades digital tools have allowed designers to significantly increase the geometrical complexity of their shapes. This caused an increase in the complexity of the fabrication of such shapes, which has often to be studied on a case to case basis. Modular structures have many qualities; among them one can list reusability and easy and fast construction, but due to the unchangeable state of their basic module, the achievable shapes are limited. The adoption of a kinetic module, a deployable unit composed of hinged rigid bodies, enhances the potentialities of modular structures. It grants larger control of the final shape and the opportunity of creating kinetic structures, allowing the design of new kinds of temporary structures.

**Keywords:** *Modular structure; Origami; Tessellation; Ron Resch; Parametric design.*

## 1. Introduction

This paper presents a study to show the potentiality of using kinetic modules to conceive modular structures, tackling the design process and proposing some fabrication and constructing solutions. At the beginning, a research on the possible exploitable principles to implement a kinetic modular system has been carried out. Rigid origami, in particular origami tessellation, turned out to be an effective reference to study kinematic modular systems. The main problems to face to design structures based on origami principles are: understanding the kinematic behaviour of the single module of the tessellation; studying a thick mechanism which preserves all the properties of the ideal zero thickness origami, allowing the physical fabrication of the module; the shaping of the whole structure according to the given constraints; and the understanding of the kinematic behaviour of the entire structure in the final and in the construction state, in order to keep it fully constraint.

The next part consists of a brief introduction on how the modular system has been conceived and how it is connected with the triangular Resch's tessellation, the tessellation chosen as a basis to design the module. The following sections will deal with the single problems of the design and of the fabrication phases. At the end, a small case study is carried out to make an evaluation of the work done and, afterwards, the conclusions will be drawn.

## 2. The modular system

Origami tessellations have proven their flexibility in the works of Tachi (2010b), where he shows how it is possible to realize almost every shape through the generalization of a regular

## Modular Structures: A Kinetic Module Based on a Resch's Tessellation

pattern of known regular tessellations. The research conducted for this work focused on regular tessellations because the modular system studied needs that all the modules to be equal. For this reason and for its capability of dealing with positive and negative Gaussian curvature the triangular Resch's tessellation (Figure 1) has been chosen.

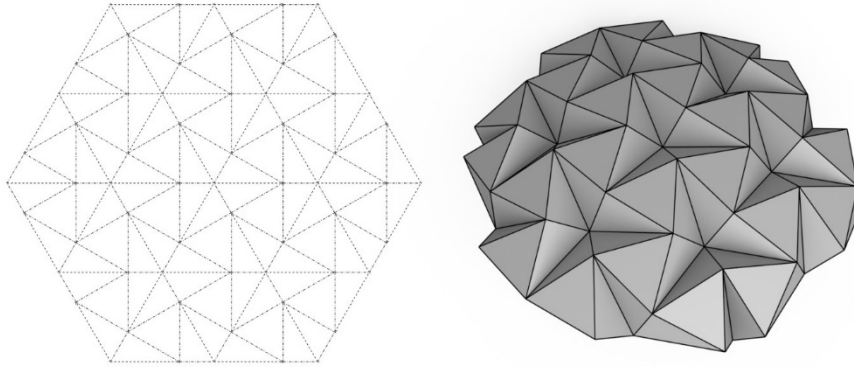

Figure 23. Folded Resch's triangular tessellation.

Within the tessellation two kinds of modules have been recognized (Figure 2). The grey equilateral triangle split into six right triangles is the kinetic module which grants the movability, while the orange one is the connector between the other modules. According to the fabrication method the connecting element, the orange one, can be integrated into the main module. The next sections will investigate how one can design and exploit the ideal properties of the modular system described above.

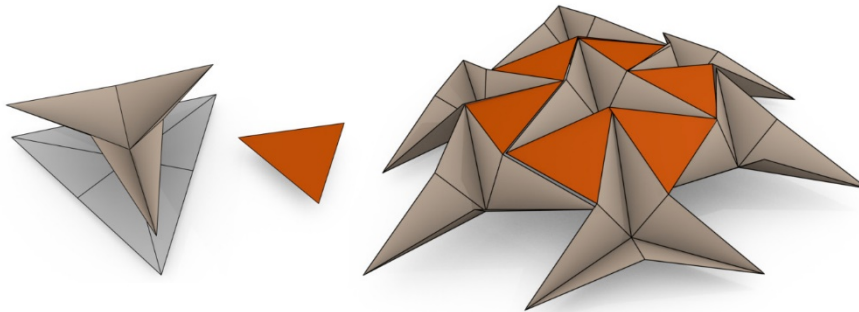

Figure 24. The modules of the modular system.

### 3. Kinematic

The kinematic study of the tessellation can be separated in two parts. One concerns the mobility of a single module, which is useful to understand how the single parts of the module behave and interact with each other's. The second considers the whole tessellation and it aims at controlling the whole shape of the structure.

#### 3.1 Single module

To analyse the behaviour of the single module a constructive geometry definition (Casale and Valenti, 2012) has been implemented in Dynamo (Figure 3), using a mix of visual scripting and associative programming (Woodbury, 2010). To decrease the number of variables, the module has been modelled imposing some symmetries, so that one parameter represents two or

more variables. Excluding the external degrees of freedom, the internal ones can be represented by the three dihedral angles between the two faces of the three tips of the module. This model is the basis for studying the fabrication of a thick mechanism which will be explained later on. It is possible to add other modules to the model, but more complex symmetries have to be used.

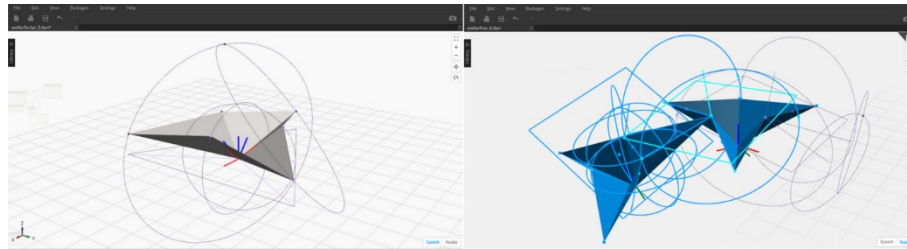

Figure 25. Dynamo screenshot: on the left the simulation of the kinematic of a single module, on the right two modules connected.

### 3.2 Rigid tessellation

Due to the nature of origami, propagation systems are not really suitable to simulate the folding of the tessellation (Woodbury, 2010). Tachi (2009) has already shown a mathematical method to implement rigid folding simulations and he offers an application to do it<sup>1</sup>. In this paper, the necessity to manage the simulation parameters according to the module configuration and the will to use open source tools has brought the author to build a custom solver to fold the tessellation. The implementation has been done in Python using Sympy to set up the various system of equations and Numpy to operate with matrices and arrays. For the visualization it is possible to interface the code with both Dynamo and Blender (Figure 4).

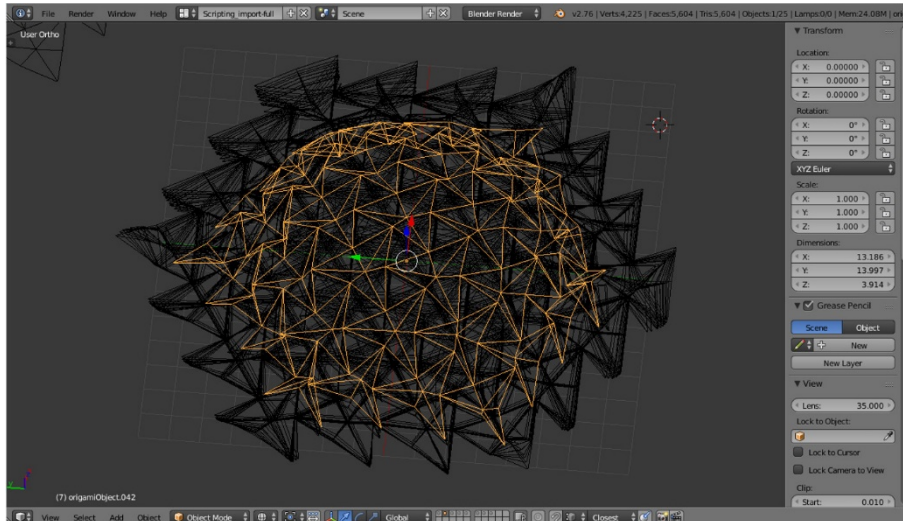

Figure 26. Blender screenshot of the rigid simulation.

The mathematical implementation is a mix of Tachi's (2010) approach and of Schenk and Guest (2011). The folding simulation takes place by imposing little displacement to every point, then the system recalculates the position of every point in such a way that the distance between two points remains the same. For the first folding phase of the plain tessellation a special function has been created to initialize the tessellation respecting the mountain and valley condition of the



## Modular Structures: A Kinetic Module Based on a Resch's Tessellation

origami. For further manipulation it is possible to act on each module deciding if it has to be displaced, closed or opened.

### 4. Rigid mechanism

Preserving the kinematic properties of origami while increasing their thickness is not a trivial problem and it is a fundamental step to build a modular system based on origami principles. Tachi (2010c) has showed that the key aspect to realize thick origami is to keep the cylindrical hinges on the same position of the edges of the ideal origami. Modifying the "Tapered Panels" methods proposed by Tachi (2010c), a parametric model has been implemented in Dynamo. It generates a rigid origami mechanism controlling the shape of non-planar panels (Figure 5-left) according to the maximum foldable value for the dihedral angle and to the thickness of the panels. To fabricate such model, the development of the panels has been cut with a laser cutter, folded and then assembled using adhesive tape (Figure 5-right).

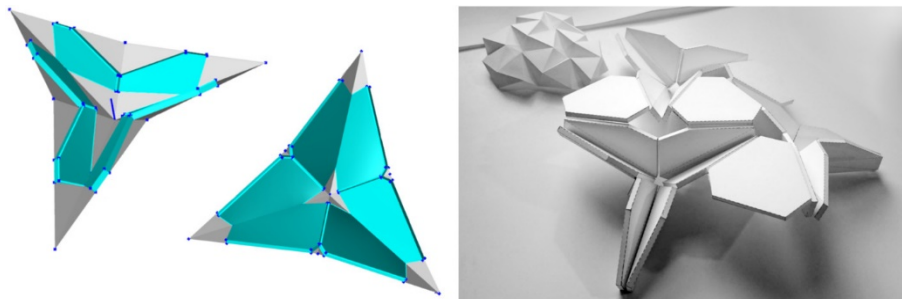

Figure 27. On the left, two thick modules realized with different parameters. On the right, the physical prototype

The second-thick mechanism solution proposed here differs from the previous one because it loses the idea of origami as unique surface and it starts from a pin-joint configuration of the tessellation. Being the pin-joint structure already aligned with the ideal origami, the main problem to solve is the intersection of six members converging in one spherical hinge. Then the hinge is substituted with six new joints, each composed of two cylindrical joints connected like a rigid body (Figure 6).

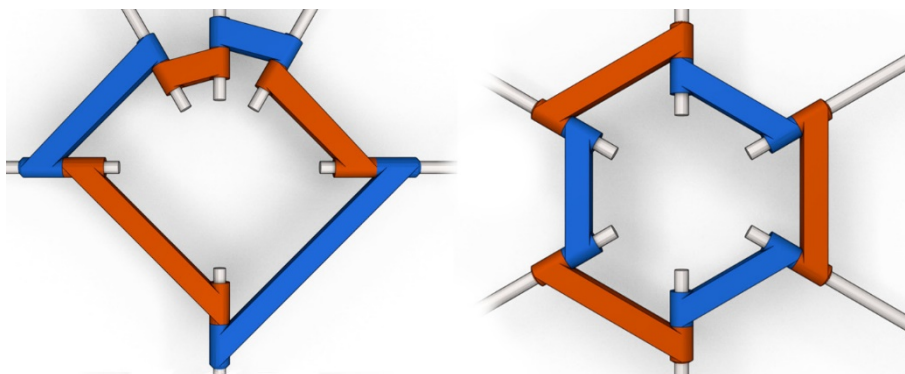

Figure 6. The two kinds of connection systems which substitute the spherical hinges.

Also in this case a parametric system has been created with Dynamo. The main constraints which govern the geometrical shape of these joints are: their physical dimension, the maximum

folding angle and the necessity to avoid the collision among the joints connected to the same member. To build a small prototype threaded rods are used as substitute of the members, while the hinges are printed with plastic in 3d (Figure 7).

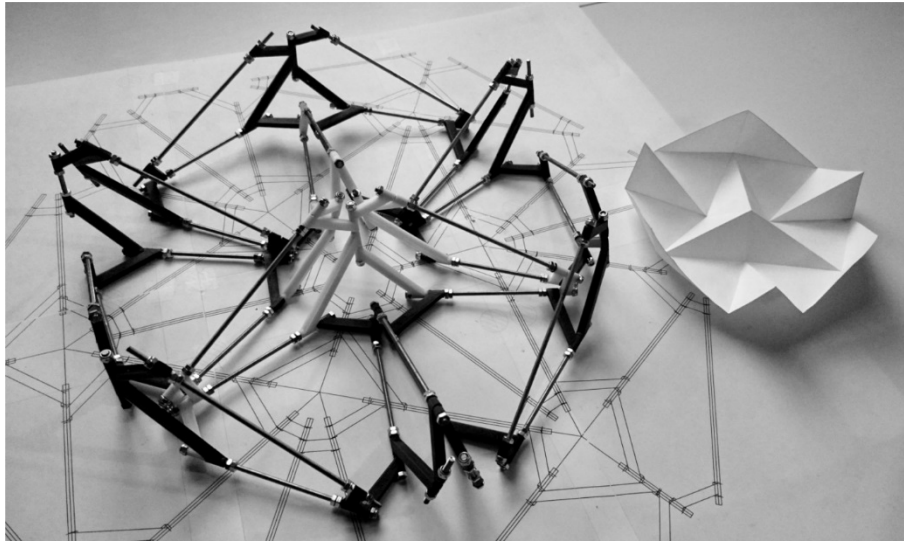

Figure 7. The physical prototype of the pin-joint mechanism.

## 5 Static and constructive consideration

Dealing with a structure that for its nature is under constrained, makes it necessary to establish a strategy to manage the kinematic freedom. In general, to fully constrain an origami tessellation it is enough to fix its boundary (Tachi, 2010b). While this could be an easy solution, folding a full scale kinematic structure of this kind or building it block by block it is not an easy task. To better understand the kinematic of the tessellation, a visual-logic process is proposed to create kinematic patterns which can limit the movability of the tessellation. The basic concept of this method is to try to understand what happens around the module which has to be blocked (Figure 8-left), or what should have happened around that module to block it (Figure 8-right).

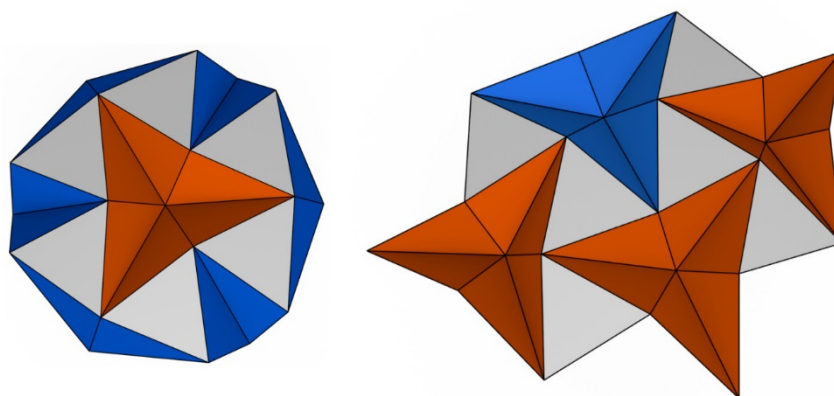

Figure 8. Two examples of the visual logic process. The orange elements are fixed externally, while the blue one are fixed due to the condition of the orange ones.

Starting from these assumptions, it is possible to create particular patterns to control the movability of the structure. The simplest one (Figure 9-left) demonstrates how it is possible to fix the structure by blocking the boundary modules, the darker ones. It also shows the possibility of



## Modular Structures: A Kinetic Module Based on a Resch's Tessellation

building the structure module by module, starting from the boundary and without using scaffolding. In Figure 9 on the right it is possible to see also a variation of it. A second pattern, shown in Figure 10, tries to arrange the fixed modules in an even way. It could be useful to spread the fixing forces on the entire structure or it could be used as basis to decide where put servo controllers to create a kinematic structure.

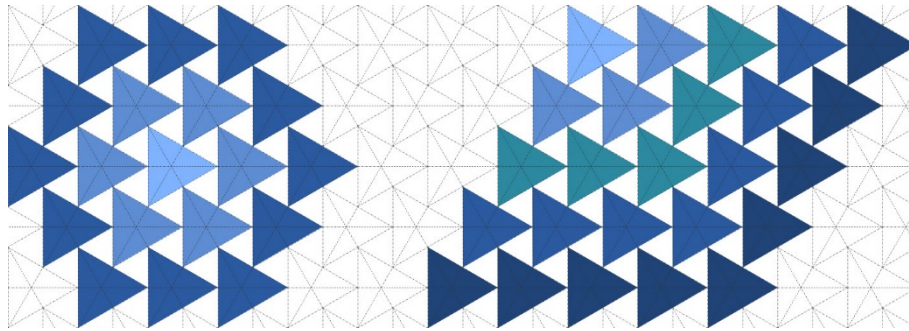

Figure 9. Kinetic patterns where only the darker modules are fixed.

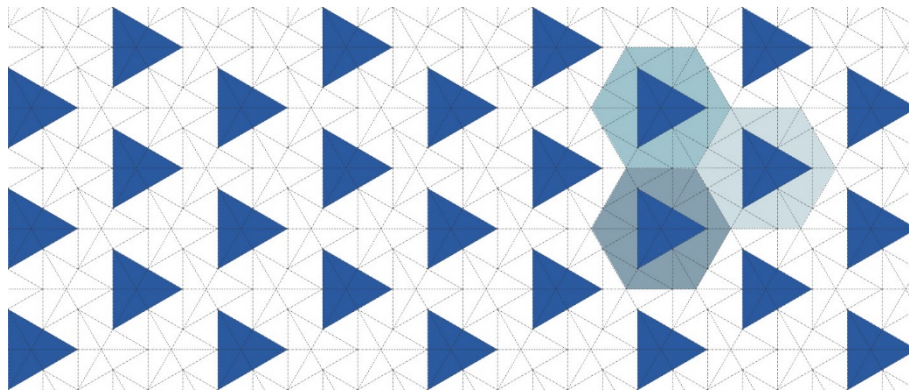

Figure 10. Another kinetic pattern

## 6 Sandbox

To test the designing tools and simulating the placement of the rigid mechanism, a fictional and very simple landscape has been created. The resulting dome based on the Resch's tessellation, covers all the volumes and grant pedestrian access over the orange surface. Then the rigid mechanisms are applied to the tessellation in Dynamo, checking that all the parameters are met (Figure 11).

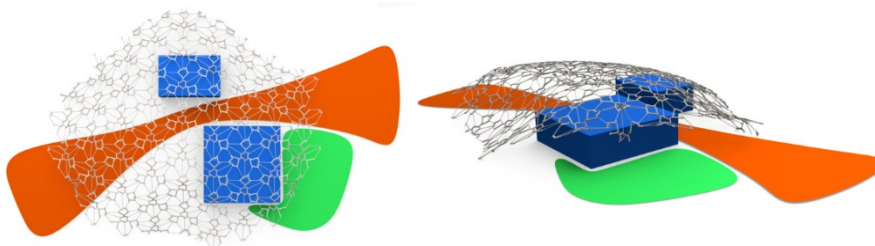

Figure 11. Sandbox scenario to test the tools. The blue volumes are buildings, the green area needs direct access to the outside and the orange area is a pedestrian zone.

## 7. Conclusion

A particular origami tessellation has been exploited to conceive a kinematic module which can be potentially used to realize an almost free form structure. On the design side, some parametric tools, based on open source libraries, have been realized to explore the possible shapes of the structure, respecting the constraints of the fabrication method. They should be improved to make them more user friendly and efficient. Two kinds of rigid mechanisms are proposed for the creation of the module. They have been conceived to preserve all the kinematic properties of the origami while other characteristics, like mechanical resistance, have not been considered yet.

Even if the work presented here is not fully developed, this paper shows the process of creating a modular structure based on a kinetic module, facing all the main challenges: the modelling of the structure, the fabrication of the module and the kinematic aspects required to effectively stiffen the structure after having built it. There is no evidence that the particular tessellation used and, in general, rigid origami are the best approach to design kinetic modules. For this reason, there is the need to investigate more deeply this solution and to look for other possible alternatives.

## Endnotes

1. "Freeform Origami" and "Rigid Origami Simulator" are available on the Tachi's website: <http://www.tsg.ne.jp/TT/>

## Acknowledgements

Hello biba... and thanks to Luigi and Marco.

## References

Casale, A. and Valenti M. G.: 2012, *Architettura delle Superfici Piegate: le geometrie che muovono gli origami*, in: *Nuovi quaderni di Applicazioni di Geometria Descrittiva*, Volume 6, Edizioni Kappa.

Schenk, M. and Guest, S. D.: 2011, *Origami Folding: A Structural Engineering Approach*, in: *Origami 5: the 5th International Conference on Origami in Science Mathematics and Education*, pp. 293-305, "Website's author": <<http://www2.eng.cam.ac.uk/~sdg/preprint/> > (accessed 10/2014).

Tachi, T.: 2009, *Simulation of Rigid Origami*, in *Origami 4: the 4th International Conference of Origami in Science, Mathematics and Education*, pp. 175-188, "Website's author": <<http://www.tsg.ne.jp/TT/cg/> > (accessed 04/2015).

Tachi, T.: 2010a, *Freeform Variations of Origami*, *Journal for Geometry and Graphics* Volume 14, No. 2, 203–215. "Website's author": <<http://www.tsg.ne.jp/TT/cg/> > (accessed 04/2015).

Tachi, T.: 2010c, *Rigid Foldable Thick Origami*, in: *Origami 5: the 5th International Conference on Origami in Science Mathematics and Education*, pp. 253-263, "Website's author": <<http://www.tsg.ne.jp/TT/cg/> > (accessed 10/2014).

Tachi, T.: 2010b, *Geometric Considerations for the Design of Rigid Origami Structures*, in *Proceedings of the International Association for Shell and Spatial Structures*, "Website's author": <<http://www.tsg.ne.jp/TT/cg/> > (accessed 10/2014).

Woodbury, R.: 2010, *Elements of Parametric Design*, Routledge, New York.

## Interactive Design for Everyone

*from folding to programming*

### **Susana Neves**

*VFabLab ISCTE - IUL*

*Lisboa, Portugal*

*fonssecaneves.susana*

*@gmail.com*

### **João Sousa**

*VFabLab ISCTE - IUL*

*Lisboa, Portugal*

*jsousaarq*

*@gmail.cm*

### **Filipa Osório**

*ISCTE - IUL*

*Lisboa, Portugal*

*filipa\_osorio*

*@iscte-iul.pt*

**Abstract:** In our society today technology is already part of the normal day life, but it is something still not available to everyone. There are some that cannot reach it the same way as others do, either because of less resources or because learning can be quite a challenge. After the development of several works with a partnership between VFabLab and EPIS that involved basic level schools, the workshop that will be explained, describes how students in special learning programs get in touch with subjects like digital fabrication; interactive architecture, design, and programming.

**Keywords:** *Digital Design Strategies, Education, Design user Participated, Interactive Architecture, Programming, Kinetic Structures, Origami.*

## **1. Introduction**

The workshop was born from a partnership between VFabLab [Vitruvius FabLab ISCTE-IUL] (ISCTE-IUL, 2012) and EPIS [Empresários Pela Inclusão Social] (Social, 2006).

VFabLab is a digital fabrication laboratory (Walter-Herrmann & Büching, 2014) that is located inside a public university and it is open either to students, companies, associations or to the general public. EPIS is an association that came to us looking for the opportunity to bring practical and technical knowledge to their students, since they have special learning programs to prevent students from leaving the school in the early years of basic education, it had to be different from the normal learning process.

The main goals of this kind of work are: to make a direct connection from the basic level to the university, allowing students to learn at the university and giving them all the available access to technology; reach out for those to whom it's harder to learn or that think about giving up studying, and provide them a new and higher level of knowledge; most of all the target is to understand the kind of inputs gave by students with a basic level of education implemented in a simple architecture project and how it can reflect in interactive design in their lives responding to every day needs.

The process used is very important and is always adapting to how the students respond to it. Origami "*like music, permits both composition and performance as expressions*" (Lang, 2004-2016). The practical character of the process clarifies geometry and some hard and complicated design and architecture structures, it allows to explore new structures through simple interactions

and to create some interesting kinetic objects. Arduino as “*an open-source prototyping platform based on easy-to-use hardware and software*” (Arduino, 2016) is intuitive and once you learn its language, experimentations and trying different approaches begin multiplying.

With these classes, the main point was to understand, by doing, how knowledge can reach everyone, either in schools or in a local community. How can an architect bring information and means to people with a low level of knowledge and create interactive design and architecture, create solutions that adjust and reshape themselves in order to respond to user’s particular needs, from the small scale object to the space or the city itself.

## **2. Origami**

A common idea is that origami is just a hobby with which you can create shapes of animals, flowers or other figures. Despite this image of origami as a “childish” hobby the truth is that it brings together a great complexity, geometry and mathematics and the use of origami is not restricted to creating small figures. We can find examples of everyday objects like pastry paper boxes, paper bags or in situations less common and far more complex, as in art works, in figures with thousands of folds, in temporary mountable and demountable shelters, in the folding of the solar panels used in space satellites or even as basis for computer programs.

Despite this presence in our daily life and even though Origami is used for hundreds of years it was only in the 80's that it began to be deeply studied and since then several of its mathematical and geometrical properties have been set.

Currently Origami is categorized into four types: traditional; rigid; modular and wet folded. The rules that define these four types have now been accepted and followed worldwide. In the workshop we focus specially in Rigid Origami type, although at the end some patterns had to be glued to create a better interaction.

In Rigid Origami is acceptable to use paper with a non-square shape, it is forbidden to glue or cut the paper and the final model must be the result of the folding of a single sheet. In this type of origami it is required that the faces defined by the creases are always flat, which means that the faces cannot bend and it must be possible to flatten the model without creating new creases.

These were some of the rules we taught to the Epis students, we used Origami to teach them about geometry. With Origami we were able to make them interested in translations, symmetries, rotations and several angular relations.

They understood that the very first thing one must learn about Origami is that there are two basic folds, the mountain and valley folds that correspond exactly to what the names suggest. (Figure 1)

## Interactive Design for Everyone: From Folding to Programing

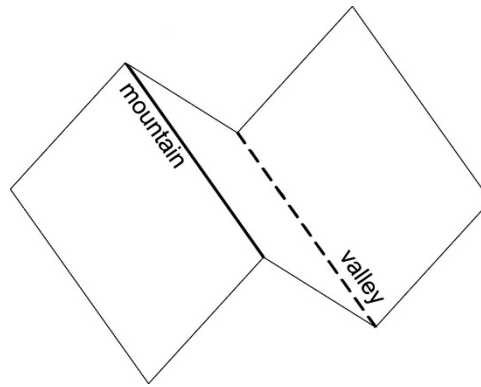

Figure 1. Basic folds: Mountain and Valley.

Origami and its geometric possibilities have been studied and used by mathematicians, physicists, engineers, architects, and even in biomedical research. In the 80's were defined the 7 axioms that summarize Origami's geometric potential.

These are the Huzita-Hatori Axioms very similar to the Euclidean axioms for constructions with straightedge and compass. The first six were defined by Huzita, the seventh was defined by Hatori in 2002, although it had already been formulated by Justin in 1996, these axioms are usually known as Huzita-Hatori or Huzita-Justin.

The students learned about these axioms and also the procedures to divide the paper in  $n$  equal and parallel parts, the methods to divide angles into  $n$  parts or degrees, construct angles of  $30^\circ$ ,  $45^\circ$ ,  $60^\circ$  and  $90^\circ$ .

With all this in mind we expected them to be able to create their own models, understand how they could move the geometries the models could assume when being put to motion by an Arduino controlled servo.

The students faced the possibility of transforming a flat element, an ordinary 80g sheet of paper, without any structural ability, into a self-supporting element through the folds allowing a variety of geometries. So, despite the material used was light, rigid and without elastic properties, such surfaces gained the power to grow, shrink and adapt to many configurations. The surfaces were folded essentially according to the rules of Rigid Origami, where is mandatory that the faces remain flat at all times and that the folds act as hinges between the various faces.

Each group made their surface acquire different configurations by applying forces at strategic points, using those forces to oblige to larger or smaller angles between the faces.

### 3. Arduino

The Arduino project started with Massimo Banzi in collaboration with four others in Interaction Design Institute Ivrea (IIDi) in Ivrea, Italy. The goal was to create a platform with simple tools for non-engineers to create digital projects based on electronics, and build it on a worldwide open community.

The Arduino is based on a previous hardware platform called Wiring and on a programming language named Processing, but the purpose here was to make it the most accessible possible and simple to use. With this open-source project created, the community has quickly grown up to

the point where there is now a series of improvements, variations and new other applications to the Arduino board. (Figure 2) It has also grown so that many people have shared their projects using Arduino with the world, spreading their knowledge but also their difficulties and restraints. This resulted in a big movement of professionals or enthusiasts with or without electronics/programming knowledge that is continuously growing with a lot of projects to the point that now, the only limit is the imagination.

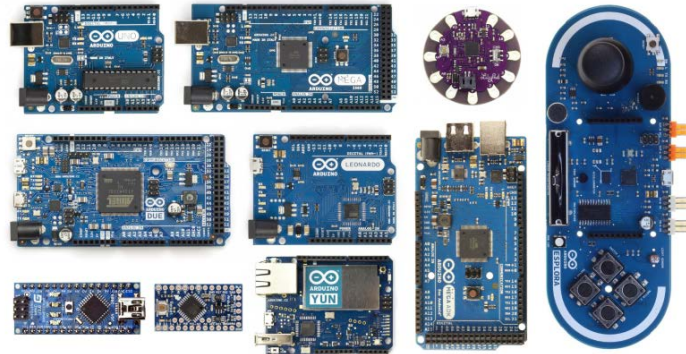

Figure 2. Varieties of Arduino.

The platform is used for several different kinds of projects, from simple toys, to objects for the user's needs, or to some more serious or professional uses. One of the great advantages of Arduino is that it allows for basic development (both software and hardware), as well as more advanced usage for professionals of the subject. It is especially interesting for teaching introduction of programming to students that do not have any kind of knowledge on the matter, which was the case on this workshop. The programming language makes it easy for students to understand the instructions, functions and variables they need to use in order to achieve their goals. The integrated development environment (IDE) is also simple and easy to use for uploading the program developed to the memory of the Arduino board in order to see if the virtual written program is doing what is intended to do in the real hardware.

The Arduino hardware is also conceived so that it can be simple to assemble using different kinds of electronic components. The Arduino Starters Kit contains a series of different components, wires, resistances and others so that anyone can start experimenting on different things and assembling their electronic projects. There is a breadboard included, where it is possible to easily connect or disconnect the different components, instead of having to solder, screw or glue the pieces.

The students learned about the basis of the programming language and the structure of the program and started playing with some basic exercises like blinking LEDs, or making light sequences with buttons. They learned also the basis of electricity in order to understand exactly what happens when they are giving commands to the electronic components. They quickly improved to the next levels and started playing with potentiometers and servomotors, varying the intensity of the light or the angle of the servo.

After the Arduino exercises they had to start thinking about how they would integrate the hardware they had available with the origami surface they had previously explored. They ended

## Interactive Design for Everyone: From Folding to Programing

up using one or two servomotors, combined with a potentiometer to control the movements of the origami. With the help of nylon wires and ring hook screws they explored different geometries and paths to make the origami move has they idealized.

### 4. Workshop: “Origami meets Arduino”

#### 4.1 Team and Workshop introduction (1<sup>st</sup> Class)

In the first class, the team was introduced and it was explained the reasons for making the workshop. The class started with the presentation of the Origami technic and the basics of Arduino. To create some expectation for the next class the students had to research both subjects by themselves so ideas would start to flow.

#### 4.2 Exercise presentation and digital fabrication (2<sup>nd</sup> Class)

The second class started with the students showing what they had found and some had already tried some folding patterns.

The exercise of the workshop was launched by introducing Digital Fabrication technics. The class had to be organized in groups and at the end of the workshop every group had to make an origami structure to cover a stadium. In this class we made a prototype of a stadium using a 2D process in a CNC milling machine and wood assembling technics. (Figure 3)



Figure 3. Students and teachers assembling the stadium prototype, later called “Vfablab Arena”

#### 4.3 Origami classes (3<sup>rd</sup> and 4<sup>th</sup> Class)

For this classes students brought what they have researched already and some were already trying to find solutions for the exercise.

The goal of this classes was to introduce the technic starting on simple patterns and evolving to more complicated ones. Although students were free to use the examples from classes, some start to invent their own mixing what they had learned with their research.

#### 4.4 Arduino classes (5<sup>th</sup> and 6<sup>th</sup> Class)

With Arduino, students got more involved as their knowledge was growing. We started the classes by making simple exercises so we could explaining how the hardware and software worked step by step.



By the end of the second class students were getting comfortable with the technology and accepting harder exercises.

#### 4.5 Origami + Arduino and Final results (7<sup>th</sup> and 8<sup>th</sup> Class)

By using the prototype it was easier to understand how it was possible to combine Origami and Arduino.

Since there was just one prototype, a small table was used for testing, allowing several positions for the servos. Some students started to realise their origami did not work and had to redesigned it, some had to carefully adjust the coding to have better results and others upgraded their origami by repeating the pattern. (Figure 4)



Figure 4. Students and teachers assembling the stadium prototype.

#### 4.6 Other options and the future (9<sup>th</sup> Class)

Once the students had finished the Arduino and Origami exercises, Professor Sancho Oliveira gave them some new challenges by exposing some examples of everyday objects that could work on simple programmable electronics, in order for them to understand how easy it is to create something with this kind of knowledge.

The workshop was finished with a last challenge, the students had to produce sound through Arduino, by the end of the class some had made a song.

### 5. Conclusions

With this workshop it was possible to verify how this kind of approach to students that have the tendency to give up studying makes them interested in this subjects, either for the opportunity of learning at the university environment or for an adaptable way of teaching that evolves depending on students' knowledge. This opportunity opened up their minds and they comprehended some real applications that they could do with what they have learned throughout the workshop.

The students had a little contact with electronics and mechanics and understood, some more than others, the challenges and possibilities of creating an interactive object. They ended up with a basic knowledge of how software and hardware works, as the students themselves had the chance of creating a small piece of software and hardware. Here the goal was to make an

## Interactive Design for Everyone: From Folding to Programing

origami surface to move, but they understood that things could be more complex like in a mobile application or a computer program.

When asked about what they have learned it was clear how well they had understood what was taught, a good example would be their idea of creating a system that would recognize their disable teacher and open the doors at school for him. With this idea it is possible to conclude that the workshop had contribute for students critical spirit and it is expected that this knowledge gives the possibility for them to contribute to the everyday needs of their local community.

### Acknowledgements

The authors would like to thank all the students that participate and gave their effort in the workshop, the teachers of the school Escola Básica da Quinta Nova da Telha, that made sure every student would have the opportunity to come to the classes, to Professor Sancho Oliveira, coordinator of VFabLab, for an inspiring class that pushed the students to the next level, to Professor Alexandra Paio, also coordinator of VFabLab, for building the partnership with EPIS.

### References

- Allan, A., 2011. iOS Sensor Apps with Arduino. s.l.:O'Reilly Media / Make .
- Arduino, 2016. <https://www.arduino.cc/en/Guide/Introduction>. [Online] [Accessed in 2016].
- Fitzgerald, S., Shiloh, M. & Igoe, T., 2012. The Arduino Projects Book. s.l.:s.n.
- ISCTE-IUL, V. F., 2012. Vitruvius FabLab ISCTE-IUL. [Online]  
Available at: <http://vitruviusfablab.iscte-iul.pt/pt-pt/news/vfablab> [Accessed in 2016].
- JACKSON, P., 2011. Folding Techniques for Designers: From Sheet to Form. London: Laurence King Publishing.
- Lang, R., 2010. Origami and Geometric Constructions. s.l.:s.n.
- Lang, R. J., 2004-2016. <http://www.langorigami.com/art/art.php>. [Online] [Accessed in 2016].
- Margolis, M., 2011. The Arduino Cookbook. s.l.:O'Reilly Media / Make.
- Social, E. – E. P. I., 2006. EPIS – Empresários Pela Inclusão Social. [Online]  
Available at: <http://www.epis.pt/homepage>
- Walter-Herrmann, J. & Büching, C., 2014. FabLab: Of Machines, Makers, and Inventors (Cultural and Media Studies). s.l.:Transcript-Verlag.



INSTITUTIONS:



SAPIENZA  
UNIVERSITÀ DI ROMA

ORGANIZATION:



ISTAR IUL  
INFORMATION SCIENCES, TECHNOLOGIES  
AND ARCHITECTURE RESEARCH CENTER  
UNIVERSITY INSTITUTE OF LISBON



instituto de  
telecomunicações

ISCTE IUL

School of Technologies and Architecture

SPONSORS:

FCT

Fundação para a Ciência e a Tecnologia  
MINISTÉRIO DA CIÊNCIA, TECNOLOGIA E ENSINO SUPERIOR

FUNDAÇÃO  
LUSO-AMERICANA

SCHOLARSHIPS SPONSORS:

ISTAR IUL

INFORMATION SCIENCES, TECHNOLOGIES  
AND ARCHITECTURE RESEARCH CENTER  
UNIVERSITY INSTITUTE OF LISBON

ISCTE IUL

School of Technologies and Architecture

SUPPORTS:



ARAÚJO & LINO  
www.araujoelino.com



sumol+compal  
Essência natureza



copianço  
IMPRESSÃO | DESIGN | PUBLICIDADE

MEDIA PARTNERS:

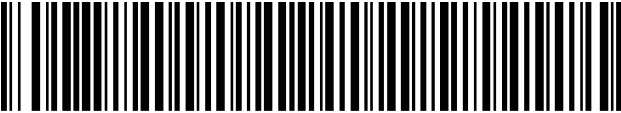

ISBN - 978-989-732-804-6